

Haskell

en.wikibooks.org

June 17, 2025

On the 28th of April 2012 the contents of the English as well as German Wikibooks and Wikipedia projects were licensed under Creative Commons Attribution-ShareAlike 3.0 Unported license. A URI to this license is given in the list of figures on page 647. If this document is a derived work from the contents of one of these projects and the content was still licensed by the project under this license at the time of derivation this document has to be licensed under the same, a similar or a compatible license, as stated in section 4b of the license. The list of contributors is included in chapter Contributors on page 631. The licenses GPL, LGPL and GFDL are included in chapter Licenses on page 653, since this book and/or parts of it may or may not be licensed under one or more of these licenses, and thus require inclusion of these licenses. The licenses of the figures are given in the list of figures on page 647. This PDF was generated by the \LaTeX typesetting software. The \LaTeX source code is included as an attachment (`source.7z.txt`) in this PDF file. To extract the source from the PDF file, you can use the `pdfdetach` tool including in the `poppler` suite, or the `http://www.pdfplabs.com/tools/pdftk-the-pdf-toolkit/` utility. Some PDF viewers may also let you save the attachment to a file. After extracting it from the PDF file you have to rename it to `source.7z`. To uncompress the resulting archive we recommend the use of `http://www.7-zip.org/`. The \LaTeX source itself was generated by a program written by Dirk Hünninger, which is freely available under an open source license from `http://de.wikibooks.org/wiki/Benutzer:Dirk_Huenniger/wb2pdf`.

Contents

1	Haskell Basics	3
2	Getting set up	5
2.1	Installing Haskell	5
2.2	First code	6
3	Variables and functions	9
3.1	Variables	9
3.2	Haskell source files	9
3.3	Comments	11
3.4	Variables in imperative languages	11
3.5	Functions	13
3.6	Local definitions	16
3.7	Summary	17
4	Truth values	19
4.1	Equality and other comparisons	19
4.2	Boolean values	20
4.3	Infix operators	21
4.4	Boolean operations	22
4.5	Guards	23
5	Type basics	25
5.1	Introduction	25
5.2	Using the interactive <code>:type</code> command	26
5.3	Functional types	27
5.4	Type signatures in code	31
6	Lists and tuples	35
6.1	Lists	35
6.2	Tuples	39
6.3	Retrieving values	41
6.4	Polymorphic types	43
6.5	Summary	45
7	Type basics II	47
7.1	The <code>Num</code> class	47
7.2	Numeric types	48
7.3	Classes beyond numbers	51

8 Building vocabulary	53
8.1 Function composition	53
8.2 The need for a vocabulary	54
8.3 Prelude and the libraries	54
8.4 One exhibit	55
8.5 This book's use of the libraries	57
8.6 Other resources	58
9 Next steps	59
9.1 if / then / else	59
9.2 Introducing pattern matching	60
9.3 Tuple and list patterns	63
9.4 let bindings	64
10 Simple input and output	67
10.1 Back to the real world	67
10.2 Sequencing actions with <i>do</i>	68
10.3 Actions under the microscope	71
10.4 Learn more	75
11 Elementary Haskell	77
12 Recursion	79
12.1 Numeric recursion	79
12.2 List-based recursion	83
12.3 Don't get TOO excited about recursion...	85
13 Lists II	87
13.1 Rebuilding lists	87
13.2 Generalizing even further	89
13.3 The <code>map</code> function	90
13.4 Tips and Tricks	91
14 Lists III	95
14.1 Folds	95
14.2 Scans	100
14.3 <code>filter</code>	101
14.4 List comprehensions	102
15 Type declarations	105
15.1 <code>data</code> and constructor functions	105
15.2 Deconstructing types	106
15.3 <code>type</code> for making type synonyms	107
16 Pattern matching	109
16.1 Analysing pattern matching	109
16.2 The connection with constructors	110
16.3 Matching literal values	111
16.4 Syntax tricks	112

16.5	Where we can use pattern matching	114
17	Control structures	117
17.1	if and guards revisited	117
17.2	case expressions	118
17.3	Controlling actions, revisited	120
18	More on functions	123
18.1	let and where revisited	123
18.2	Anonymous Functions - lambdas	124
18.3	Operators	125
19	Higher-order functions	127
19.1	A sorting algorithm	127
19.2	Choosing how to compare	128
19.3	Higher-Order Functions and Types	129
19.4	Function manipulation	131
20	Using GHCi effectively	135
20.1	User interface	135
21	Intermediate Haskell	137
22	Modules	139
22.1	Modules	139
22.2	Importing	139
22.3	Exporting	142
23	Indentation	143
23.1	The golden rule of indentation	143
23.2	Explicit characters in place of indentation	144
23.3	Layout in action	145
24	More on datatypes	149
24.1	Enumerations	149
24.2	Named Fields (Record Syntax)	149
24.3	Parameterized Types	152
25	Other data structures	155
25.1	Trees	155
25.2	Other datatypes	159
26	Classes and types	165
26.1	Classes and instances	165
26.2	Deriving	166
26.3	Class inheritance	167
26.4	Standard classes	168
26.5	Type constraints	169
26.6	A concerted example	170

27 The Functor class	173
27.1 Motivation	173
27.2 Introducing Functor	173
27.3 What did we gain?	175
28 Monads	177
29 Prologue: IO, an applicative functor	179
29.1 Scene 1 : Applicative	179
29.2 Scene 2 : IO	183
29.3 The end of the beginning	187
30 Understanding monads	189
30.1 Definition	189
30.2 Notions of Computation	192
30.3 Monad Laws	195
30.4 Monads and Category Theory	196
30.5 liftM and Friends	196
31 The Maybe monad	199
31.1 Safe functions	199
31.2 Lookup tables	200
31.3 Extracting values	201
31.4 Maybe and safety	202
32 The List monad	203
32.1 The Monad instance of lists	203
32.2 Bunny invasion	204
32.3 Board game example	204
32.4 List comprehensions	205
33 do Notation	207
33.1 Translating the <i>then</i> operator	207
33.2 Translating the <i>bind</i> operator	208
33.3 Example: user-interactive program	210
33.4 Returning values	210
33.5 Just sugar	211
34 The IO monad	213
34.1 Combining functions and I/O actions	213
34.2 The universe as part of our program	215
34.3 Pure and impure	215
34.4 Functional and imperative	216
34.5 I/O in the libraries	217
34.6 Monadic control structures	217
35 The State monad	219
35.1 Pseudo-Random Numbers	219
35.2 Introducing State	223

35.3 Pseudo-random values of different types	230
36 Alternative and MonadPlus	233
36.1 Definition	233
36.2 Example: parallel parsing	234
36.3 MonadPlus	234
36.4 Alternative and MonadPlus laws	235
36.5 Useful functions	235
36.6 Exercises	238
36.7 Relationship with monoids	238
36.8 Other suggested laws	239
37 Monad transformers	241
37.1 Passphrase validation	241
37.2 A simple monad transformer: <code>MaybeT</code>	242
37.3 A plethora of transformers	244
37.4 Lifting	245
37.5 Implementing transformers	247
37.6 Acknowledgements	249
38 Advanced Haskell	251
39 Monoids	253
39.1 What is a monoid?	253
39.2 The <code>Monoid</code> class	254
39.3 Uses	255
39.4 Homomorphisms	259
39.5 Further reading	260
40 Applicative functors	261
40.1 Functor recap	261
40.2 Application in functors	262
40.3 The <code>Applicative</code> class	263
40.4 Déjà vu	264
40.5 <code>ZipList</code>	265
40.6 Sequencing of effects	267
40.7 A sliding scale of power	269
40.8 The monoidal presentation	272
41 Foldable	275
41.1 Deconstructing <code>foldr</code>	275
41.2 The <code>Foldable</code> class	277
41.3 List-like folding	279
41.4 More facts about <code>Foldable</code>	280
42 Traversable	283
42.1 Functors made for walking	283
42.2 Interpretations of <code>Traversable</code>	285
42.3 The <code>Traversable</code> laws	286

42.4 Recovering <code>fmap</code> and <code>foldMap</code>	288
43 Arrow tutorial	291
43.1 Stephen's Arrow Tutorial	291
43.2 Type definition for <code>Circuit</code>	292
43.3 <code>Circuit</code> primitives	293
43.4 Arrow <code>proc</code> notation	293
43.5 Hangman: Pick a word	294
43.6 Hangman: Main program	296
43.7 Advanced stuff	297
44 Understanding arrows	301
44.1 Pocket guide to <code>Arrow</code>	301
44.2 Using arrows	310
44.3 Arrows in practice	315
44.4 See also	315
44.5 Acknowledgements	315
45 Continuation passing style (CPS)	317
45.1 What are continuations?	317
45.2 Passing continuations	318
45.3 The <code>Cont</code> monad	320
45.4 <code>callCC</code>	321
45.5 Example: a complicated control structure	324
45.6 Example: exceptions	326
45.7 Example: coroutines	327
45.8 Example: Implementing pattern matching	329
46 Zippers	331
46.1 Theseus and the Zipper	331
46.2 Differentiation of data types	340
46.3 See Also	348
47 Lenses and functional references	349
47.1 A taste of lenses	349
47.2 The scenic route to lenses	351
47.3 Composition	360
47.4 Operators	361
47.5 A swiss army knife	362
47.6 Laws	367
47.7 No strings attached	368
47.8 Further reading	369
48 Mutable objects	371
48.1 <code>IORefs</code>	371
48.2 The <code>ST</code> monad	374
48.3 Mutable data structures	375
48.4 Further reading	376

49	Concurrency	377
49.1	Concurrency	377
49.2	When do you need it?	377
49.3	Example	378
49.4	Software Transactional Memory	378
50	Fun with Types	379
51	Polymorphism basics	381
51.1	Parametric Polymorphism	381
51.2	System F	384
51.3	Examples	384
51.4	Other forms of Polymorphism	384
51.5	Free Theorems	386
51.6	See also	386
52	Existentially quantified types	387
52.1	The <code>forall</code> keyword	387
52.2	Example: heterogeneous lists	388
52.3	A Further Explanation	389
52.4	Example: <code>runST</code>	391
52.5	Quantified Types as Products and Sums	393
52.6	Quantification as a primitive	394
52.7	Further reading	395
53	Advanced type classes	397
53.1	Multi-parameter type classes	397
53.2	Functional dependencies	398
54	Phantom types	401
54.1	Phantom types	401
55	Generalised algebraic data-types (GADT)	403
55.1	Understanding GADTs	403
55.2	Summary	407
55.3	Examples	408
55.4	Discussion	412
56	Type constructors & Kinds	413
56.1	Kinds for C++ users	413
57	Wider Theory	415
58	Denotational semantics	417
58.1	Introduction	417
58.2	Bottom and Partial Functions	420
58.3	Recursive Definitions as Fixed Point Iterations	424
58.4	Strict and Non-Strict Semantics	429
58.5	Algebraic Data Types	431

58.6 Other Selected Topics	441
58.7 External Links	443
59 Category theory	445
59.1 Introduction to categories	445
59.2 Functors	448
59.3 Monads	451
59.4 The monad laws and their importance	453
59.5 Summary	458
60 The Curry-Howard isomorphism	459
60.1 Introduction	459
60.2 Logical operations and their equivalents	461
60.3 Axiomatic logic and the combinatory calculus	463
60.4 Sample proofs	465
60.5 Intuitionistic vs classical logic	465
61 fix and recursion	467
61.1 Introducing fix	467
61.2 fix and fixed points	469
61.3 Recursion	470
61.4 The typed lambda calculus	472
61.5 Fix as a data type	473
62 Haskell Performance	475
63 Introduction	477
63.1 Execution Model	477
63.2 Algorithms & Data Structures	481
63.3 Parallelism	482
64 Step by Step Examples	485
64.1 Tight loop	485
64.2 CSV Parsing	485
64.3 Space Leak	485
65 Graph reduction	487
65.1 Notes and TODOs	487
65.2 Introduction	487
65.3 Evaluating Expressions by Lazy Evaluation	488
65.4 Controlling Space	495
65.5 Reasoning about Time	496
65.6 Implementation of Graph reduction	498
65.7 References	498
66 Laziness	499
66.1 Introduction	499
66.2 Thunks and Weak head normal form	499
66.3 Lazy and strict functions	502

66.4	Lazy pattern matching	505
66.5	Benefits of nonstrict semantics	506
66.6	Common nonstrict idioms	508
66.7	Conclusions about laziness	510
66.8	References	510
67	Strictness	511
67.1	Difference between strict and lazy evaluation	511
67.2	Why laziness can be problematic	511
67.3	Strictness annotations	512
67.4	seq	512
67.5	References	512
68	Algorithm complexity	513
68.1	Optimising	514
69	Libraries Reference	515
70	The Hierarchical Libraries	517
70.1	Haddock Documentation	517
71	Lists	519
71.1	Theory	519
71.2	Definition	519
71.3	Basic list usage	520
71.4	List utilities	521
72	Arrays	523
72.1	Quick reference	523
72.2	Immutable arrays	523
72.3	Mutable IO arrays	524
72.4	Mutable arrays in ST monad	524
72.5	Freezing and thawing	525
72.6	DiffArray	526
72.7	Unboxed arrays	527
72.8	StorableArray	528
72.9	The Haskell Array Preprocessor (STPP)	529
72.10	ArrayRef library	529
72.11	Unsafe operations and running over array elements	529
72.12	GHC-specific topics	530
73	Maybe	535
73.1	Definition	535
73.2	Library functions	535
74	Maps	539
74.1	Motivation	539
74.2	Library functions	539
74.3	Example	539

75 IO	543
75.1 The IO Library	543
75.2 Bracket	544
75.3 A File Reading Program	544
76 Random Numbers	547
76.1 Random examples	547
76.2 The Standard Random Number Generator	548
76.3 Using QuickCheck to Generate Random Data	551
77 General Practices	555
78 Building a standalone application	557
78.1 The Main module	557
78.2 Other modules	557
79 Debugging	559
79.1 Debug prints with <code>Debug.Trace</code>	559
79.2 Incremental development with <code>GHCi</code>	561
79.3 Debugging with <code>Hat</code>	561
79.4 General tips	561
80 Testing	563
80.1 Quickcheck	563
80.2 <code>HUnit</code>	566
81 Packaging your software (Cabal)	567
81.1 Recommended tools	567
81.2 Structure of a simple project	568
81.3 Libraries	574
81.4 Automation	576
81.5 Licenses	577
81.6 Releases	577
81.7 Hosting	578
81.8 Example	578
82 Using the Foreign Function Interface (FFI)	579
82.1 Calling C from Haskell	579
82.2 Calling Haskell from C	592
83 Generic Programming : Scrap your boilerplate	595
83.1 Serialization Example	595
83.2 Comparing Haskell ASTs	595
83.3 TODO	596
84 Specialised Tasks	597
85 Graphical user interfaces (GUI)	599
85.1 Getting and running <code>wxHaskell</code>	599

85.2 Hello World	600
85.3 Controls	601
85.4 Layout	603
85.5 Attributes	607
85.6 Events	609
86 Databases	611
86.1 Introduction	611
86.2 Installation	611
86.3 General Workflow	612
86.4 Running SQL Statements	613
86.5 Transaction	613
86.6 Calling Procedure	613
87 Web programming	615
88 Working with XML	617
88.1 Getting acquainted with HXT	617
89 Using Regular Expressions	621
90 Parsing Mathematical Expressions	623
90.1 First Warmup	623
90.2 Adaptation	624
90.3 Structure Emerges	626
90.4 Whitespace and applicative notation	627
91 Contributors	631
List of Figures	647
92 Licenses	653
92.1 GNU GENERAL PUBLIC LICENSE	653
92.2 GNU Free Documentation License	654
92.3 GNU Lesser General Public License	655

1 Haskell Basics

2 Getting set up

This chapter describes how to install the programs you'll need to start coding in Haskell.

2.1 Installing Haskell

Haskell is a *programming language*, i.e. a language in which humans can express how computers should behave. It's like writing a cooking recipe: you write the recipe and the computer executes it.

To use Haskell programs, you need a special program called a Haskell *compiler*. A compiler takes code written in Haskell and translates it into *machine code*, a more elementary language that the computer understands. Using the cooking analogy, you write a recipe (your Haskell program) and a cook (a compiler program) does the work of putting together actual ingredients into an edible dish (an executable file). Of course, you can't easily get the recipe from a final dish (and you can't get the Haskell program code from executable after it's compiled).

To get started, see haskell.org/downloads¹ for the latest instructions including the "Glasgow Haskell Compiler" (GHC) and everything else you need.

To just test some Haskell basics without downloading and installing, the Haskell.org home page² includes a simplified interpreter right on the website. The instructions here in the Wikibook assume the full GHC install, but some of the basics can work in the website version.

Note:

UNIX users:

If you are a person who prefers to compile from source: This might be a bad idea with GHC, especially if it's the first time you install it. GHC is itself mostly written in Haskell, so trying to bootstrap it by hand from source is very tricky. Besides, the build takes a *very* long time and consumes a lot of disk space. If you are sure that you want to build GHC from the source, see Building and Porting GHC at the GHC homepage^a.

^a <http://hackage.haskell.org/trac/ghc/wiki/Building>

¹ <https://www.haskell.org/downloads>

² <https://www.haskell.org/>

2.2 First code

After installation, we will do our first Haskell coding with the program called **GHCi** (the 'i' stands for 'interactive'). Depending on your operating system, perform the following steps:

- On Windows: Click Start, then Run, then type 'cmd' and hit Enter, then type `ghci` and hit Enter once more.
- On MacOS: Open the application "Terminal" found in the "Applications/Utilities" folder, type the letters `ghci` into the window that appears, and hit the Enter key.
- On Linux: Open a terminal and run `ghci`.

You should get output that looks something like the following:

```
GHCi, version 7.10.1: http://www.haskell.org/ghc/  :? for help
Loading package ghc-prim ... linking ... done.
Loading package integer-gmp ... linking ... done.
Loading package base ... linking ... done.
Prelude>
```

The first bit is GHCi's version. It then informs you that it's loading the base package, so you'll have access to most of the built-in functions and modules that come with GHC. Finally, the `Prelude>` bit is known as the *prompt*. This is where you enter commands, and GHCi will respond with their results.

Now let's try some basic arithmetic:

```
Prelude> 2 + 2
4
Prelude> 5 + 4 * 3
17
Prelude> 2 ^ 5
32
```

These operators match most other programming languages: `+` is addition, `*` is multiplication, and `^` is exponentiation (raising to the power of, or a^b). As shown in the second example, Haskell follows standard order of math operations (e.g. multiplication before addition).

Now you know how to use Haskell as a calculator. Actually, Haskell is *always* a calculator — just a really powerful one, able to deal not only with numbers but also with other objects like characters, lists, functions, trees, and even other programs (if you aren't familiar with these terms yet, don't worry).

To leave GHCi once you are done, use `:quit` (or just `:q`):

```
Prelude> :quit
Leaving GHCi.
```

GHCi is a powerful development environment. As we progress, we will learn how to load files with source code into GHCi and evaluate different parts of them.

Assuming you're clear on everything so far (if not, use the talk page and help us improve this Wikibook!), then you are ready for next chapter where we will introduce some of the basic concepts of Haskell and make our first Haskell functions.

3 Variables and functions

All the examples in this chapter can be saved into a Haskell source file and then evaluated by loading that file into GHC. Do not include the "Prelude>" prompts part of any example. When that prompt is shown, it means you can type the following code into an environment like GHCi. Otherwise, you should put the code in a file and run it.

3.1 Variables

In the last chapter, we used GHCi as a calculator. Of course, that's only practical for short calculations. For longer calculations and for writing Haskell programs, we want to keep track of intermediate results.

We can store intermediate results by assigning them names. These names are called *variables*. When a program runs, each variable is substituted for the *value* to which it refers. For instance, consider the following calculation

```
Prelude> 3.141592653 * 5^2
78.539816325
```

That is the approximate area of a circle with radius 5, according to the formula $A = \pi r^2$. Of course, it is cumbersome to type in the digits of $\pi \approx 3.141592653$, or even to remember more than the first few. Programming helps us avoid mindless repetition and rote memorization by delegating these tasks to a machine. That way, our minds stay free to deal with more interesting ideas. For the present case, Haskell already includes a variable named `pi` that stores over a dozen digits of π for us. This allows for not just clearer code, but also greater precision.

```
Prelude> pi
3.141592653589793
Prelude> pi * 5^2
78.53981633974483
```

Note that the variable `pi` and its value, 3.141592653589793, can be used interchangeably in calculations.

3.2 Haskell source files

Beyond momentary operations in GHCi, you will save your code in Haskell source files (basically plain text) with the extension `.hs`. Work with these files using a text editor

appropriate for coding (see the Wikipedia article on text editors¹). Proper source code editors will provide *syntax highlighting*, which colors the code in relevant ways to make reading and understanding easier. Vim and Emacs are popular choices among Haskell programmers.

To keep things tidy, create a directory (i.e. a folder) in your computer to save the Haskell files you will create while doing the exercises in this book. Call the directory something like `HaskellWikibook`. Then, create a new file in that directory called `Varfun.hs` with the following code:

```
r = 5.0
```

That code defines the variable `r` as the value `5.0`.

Note: make sure that there are no spaces at the beginning of the line because Haskell is sensitive to whitespace.

Next, with your terminal at the `HaskellWikibook` directory, start `GHCi` and load the `Varfun.hs` file using the `:load` command:

```
Prelude> :load Varfun.hs
[1 of 1] Compiling Main           ( Varfun.hs, interpreted )
Ok, modules loaded: Main.
```

Note that `:load` can be abbreviated as `:l` (as in `:l Varfun.hs`).

If `GHCi` gives an error like `Could not find module 'Varfun.hs'`, you probably running `GHCi` in the wrong directory or saved your file in the wrong directory. You can use the `:cd` command to change directories within `GHCi` (for instance, `:cd HaskellWikibook`).

With the file loaded, `GHCi`'s prompt changes from `"Prelude"` to `"*Main"`. You can now use the newly defined variable `r` in your calculations.

```
• Main> r 5.0
• Main> pi * r^2 78.53981633974483
```

So, we calculated the area of a circle with radius of `5.0` using the well-known formula πr^2 . This worked because we defined `r` in our `Varfun.hs` file and `pi` comes from the standard Haskell libraries.

Next, we'll make the area formula easier to quickly access by defining a variable name for it. Change the contents of the source file to:

```
r = 5.0
area = pi * r ^ 2
```

Save the file. Then, assuming you kept `GHCi` running with the file still loaded, type `:reload` (or abbreviate version `:r`).

¹ <https://en.wikipedia.org/wiki/text%20editor>

```

• Main> :reload Compiling Main ( Varfun.hs, interpreted ) Ok, modules loaded: Main.
• Main>

```

Now we have two variables `r` and `area`.

```

• Main> area 78.53981633974483
• Main> area / r 15.707963267948966

```

Note:

Note: The `let` *keyword* (a word with a special meaning) lets us define variables directly at the GHCi prompt without a source file. This looks like:

```
Prelude> let area = pi * 5 ^ 2
```

Although sometimes convenient, assigning variables entirely in GHCi this way is impractical for any complex tasks. We will usually want to use saved source files.

3.3 Comments

Besides the working code itself, source files may contain text *comments*. In Haskell there are two types of comment. The first starts with `--` and continues until the end of the line:

```

x = 5    -- x is 5.
y = 6    -- y is 6.
-- z = 7 -- z is not defined.

```

In this case, `x` and `y` are defined in actual Haskell code, but `z` is not.

The second type of comment is denoted by an enclosing `{- ... -}` and can span multiple lines:

```

answer = 2 * {-
  block comment, crossing lines and...
-} 3 {- inline comment. -} * 7

```

We use comments for explaining parts of a program or making other notes in context. Beware of comment overuse as too many comments can make programs harder to read. Also, we must carefully update comments whenever we change the corresponding code. Outdated comments can cause significant confusion.

3.4 Variables in imperative languages

Readers familiar with imperative programming will notice that variables in Haskell seem quite different from variables in languages like C. If you have no programming experience, you could skip this section, but it will help you understand the general situation when encountering the many cases (most Haskell textbooks, for example) where people discuss Haskell in reference to other programming languages.

Imperative programming treats variables as changeable locations in a computer's memory. That approach connects to the basic operating principles of computers. Imperative programs explicitly tell the computer what to do. Higher-level imperative languages are quite removed from direct computer assembly code instructions, but they retain the same step-by-step way of thinking. In contrast, *functional programming* offers a way to think in higher-level mathematical terms, defining how variables relate to one another, leaving the compiler to translate these to the step-by-step instructions that the computer can process.

Let's look at an example. The following code does not work in Haskell:

```
r = 5
r = 2
```

An imperative programmer may read this as first setting `r = 5` and then changing it to `r = 2`. In Haskell, however, the compiler will respond to the code above with an error: "multiple declarations of `r`". Within a given scope, a variable in Haskell gets defined only once and cannot change.

The variables in Haskell seem almost *invariable*, but they work like variables in mathematics. In a math classroom, you never see a variable change its value within a single problem.

In precise terms, Haskell variables are *immutable*. They vary only based on the data we enter into a program. We can't define `r` two ways in the same code, but we could change the value by changing the file. Let's update our code from above:

```
r = 2.0
area = pi * r ^ 2
```

Of course, that works just fine. We can change `r` in the one place where it is defined, and that will automatically update the value of all the rest of the code that uses the `r` variable.

Real-world Haskell programs work by leaving *some* variables unspecified in the code. The values then get defined when the program gets data from an external file, a database, or user input. For now, however, we will stick to defining variables internally. We will cover interaction with external data in later chapters.

Here's one more example of a major difference from imperative languages:

```
r = r + 1
```

Instead of "incrementing the variable `r`" (i.e. updating the value in memory), this Haskell code is a recursive definition of `r` (i.e. defining it in terms of itself). We will explain recursion² in detail later on. For this specific case, if `r` had been defined with any value beforehand, then `r = r + 1` in Haskell would bring an error message. `r = r + 1` is akin to saying, in a mathematical context, that $5 = 5 + 1$, which is plainly wrong.

Because their values do not change within a program, variables can be defined in any order. For example, the following fragments of code do exactly the same thing:

² Chapter 12 on page 79

```
y = x * 2
x = 3
```

```
x = 3
y = x * 2
```

In Haskell, there is no notion of "x being declared before y" or the other way around. Of course, using y will still require a value for x, but this is unimportant until you need a specific numeric value.

3.5 Functions

Changing our program every time we want to calculate the area of new circle is both tedious and limited to one circle at a time. We could calculate two circles by duplicating all the code using new variables `r2` and `area2` for the second circle:³

```
r = 5
area = pi * r ^ 2
r2 = 3
area2 = pi * r2 ^ 2
```

Of course, to eliminate this mindless repetition, we would prefer to have simply one *function* for area and then apply it to different radii.

A *function* takes an *argument* value (or *parameter*) and gives a result value (essentially the same as in mathematical functions). Defining functions in Haskell is like defining a variable, except that we take note of the function argument that we put on the left hand side. For instance, the following defines a function `area` which depends on an argument named `r`:

```
area r = pi * r ^ 2
```

Look closely at the syntax: the function name comes first (`area` in our example), followed by a space and then the argument (`r` in the example). Following the = sign, the *function definition* is a formula that uses the argument in context with other already defined terms.

Now, we can plug in different values for the argument in a *call* to the function. Save the code above in a file, load it into GHCi, and try the following:

```
• Main> area 5 78.53981633974483
• Main> area 3 28.274333882308138
• Main> area 17 907.9202768874502
```

Thus, we can *call* this function with different radii to calculate the area of any circle.

Our function here is defined mathematically as

$$A(r) = \pi \cdot r^2$$

³ As this example shows, the names of variables may contain numbers as well as letters. Variables in Haskell *must* begin with a lowercase letter but may then have any string consisting of letter, numbers, underscore (`_`) or tick (`'`).

In mathematics, the parameter is enclosed between parentheses, as in $A(5) = 78.54$ or $A(3) = 28.27$. Haskell code will also work with parentheses, but we omit them as a convention. Haskell uses functions all the time, and whenever possible we want to minimize extra symbols.

We still use parentheses for grouping *expressions* (any code that gives a value) that must be evaluated together. Note how the following expressions are parsed differently:

```
5 * 3 + 2      -- 15 + 2 = 17 (multiplication is done before addition)
5 * (3 + 2)    -- 5 * 5 = 25 (thanks to the parentheses)
area 5 * 3     -- (area 5) * 3
area (5 * 3)   -- area 15
```

Note that Haskell functions take *precedence* over all other operators such as $+$ and $*$, in the same way that, for instance, multiplication is done before addition in mathematics.

3.5.1 Evaluation

What exactly happens when you enter an expression into GHCi? After you press the enter key, GHCi will *evaluate* the expression you have given. That means it will replace each function with its definition and calculate the results until a single value remains. For example, the evaluation of `area 5` proceeds as follows:

```
area 5
=> { replace the left-hand side area r = ... by the right-hand side ... =
pi * r^2 }
pi * 5 ^ 2
=> { replace pi by its numerical value }
3.141592653589793 * 5 ^ 2
=> { apply exponentiation (^) }
3.141592653589793 * 25
=> { apply multiplication (*) }
78.53981633974483
```

As this shows, to *apply* or *call* a function means to replace the left-hand side of its definition by its right-hand side. When using GHCi, the results of a function call will then show on the screen.

Some more functions:

```
double x      = 2 * x
quadruple x   = double (double x)
square x      = x * x
half x        = x / 2
```

Exercises:

- Explain how GHCi evaluates `quadruple 5`.
- Define a function that subtracts 12 from half its argument.

3.5.2 Multiple parameters

Functions can also take more than one argument. For example, a function for calculating the area of a rectangle given its length and width:

```
areaRect l w = l * w
```

```
• Main> areaRect 5 10 50
```

Another example that calculates the area of a triangle ($A = \frac{bh}{2}$):

```
areaTriangle b h = (b * h) / 2
```

```
• Main> areaTriangle 3 9 13.5
```

As you can see, multiple arguments are separated by spaces. That's also why you sometimes have to use parentheses to group expressions. For instance, to quadruple a value `x`, you can't write

```
quadruple x = double double x    -- error
```

That would apply a function named `double` to the two arguments `double` and `x`. Note that *functions can be arguments to other functions* (you will see why later). To make this example work, we need to put parentheses around the argument:

```
quadruple x = double (double x)
```

Arguments are always passed in the order given. For example:

```
minus x y = x - y
```

```
• Main> minus 10 5 5
• Main> minus 5 10 -5
```

Here, `minus 10 5` evaluates to `10 - 5`, but `minus 5 10` evaluates to `5 - 10` because the order changes.

Exercises:

- Write a function to calculate the volume of a box.
- Approximately how many stones are the famous pyramids at Giza made up of? Hint: you will need estimates for the volume of the pyramids and the volume of each block.

3.5.3 On combining functions

Of course, you can use functions that you have already defined to define new functions, just like you can use the predefined functions like addition (+) or multiplication (*) (operators are defined as functions in Haskell). For example, to calculate the area of a square, we can reuse our function that calculates the area of a rectangle:

```
areaRect l w = l * w
areaSquare s = areaRect s s
```

- Main> areaSquare 5 25

After all, a square is just a rectangle with equal sides.

Exercises:

- Write a function to calculate the volume of a cylinder. The volume of a cylinder is the area of the base, which is a circle (you already programmed this function in this chapter, so reuse it) multiplied by the height.

3.6 Local definitions

3.6.1 where clauses

When defining a function, we sometimes want to define intermediate results that are *local* to the function. For instance, consider Heron's formula⁴ $A = \sqrt{s(s-a)(s-b)(s-c)}$ for calculating the area of a triangle with sides *a*, *b*, and *c*:

```
heron a b c = sqrt (s * (s - a) * (s - b) * (s - c))
  where
    s = (a + b + c) / 2
```

The variable *s* is half the perimeter of the triangle and it would be tedious to write it out four times in the argument of the square root function `sqrt`.

Simply writing the definitions in sequence does not work...

```
heron a b c = sqrt (s * (s - a) * (s - b) * (s - c))
s = (a + b + c) / 2 -- a, b, and c are not
defined here
```

... because the variables *a*, *b*, *c* are only available in the right-hand side of the function `heron`, but the definition of *s* as written here is not part of the right-hand side of `heron`. To make it part of the right-hand side, we use the `where` keyword.

Note that both the `where` and the local definitions are *indented* by 4 spaces, to distinguish them from subsequent definitions. Here is another example that shows a mix of local and top-level definitions:

```
areaTriangleTrig a b c = c * height / 2 -- use trigonometry
  where
    cosa = (b ^ 2 + c ^ 2 - a ^ 2) / (2 * b * c)
    sina = sqrt (1 - cosa ^ 2)
    height = b * sina
areaTriangleHeron a b c = result -- use Heron's formula
  where
```

⁴ <https://en.wikipedia.org/wiki/Heron%27s%20formula>

```
result = sqrt (s * (s - a) * (s - b) * (s - c))
s      = (a + b + c) / 2
```

3.6.2 Scope

If you look closely at the previous example, you'll notice that we have used the variable names `a`, `b`, `c` twice, once for each of the two area functions. How does that work?

Consider the following GHCi sequence:

```
Prelude> let r = 0
Prelude> let area r = pi * r ^ 2
Prelude> area 5
78.53981633974483
```

It would have been an unpleasant surprise to return `0` for the area because of the earlier `let r = 0` definition getting in the way. That does not happen because when you defined `r` the second time you are talking about a *different* `r`. This may seem confusing, but consider how many people have the name John, and yet for any context with only one John, we can talk about "John" with no confusion. Programming has a notion similar to context, called *scope*⁵.

We will not explain the technicalities behind scope right now. Just keep in mind that the value of a parameter is strictly what you pass in when you call the function, regardless of what the variable was called in the function's definition. That said, appropriately unique names for variables do make the code easier for human readers to understand.

3.7 Summary

1. Variables store values (which can be any arbitrary Haskell expression).
2. Variables do not change within a scope.
3. Functions help you write reusable code.
4. Functions can accept more than one parameter.

We also learned about non-code text comments within a source file.

⁵ <https://en.wikipedia.org/wiki/Scope%20%28programming%29>

4 Truth values

4.1 Equality and other comparisons

In the last chapter, we used the equals sign to define variables and functions in Haskell as in the following code:

```
r = 5
```

That means that the evaluation of the program replaces all occurrences of `r` with 5 (within the scope of the definition). Similarly, evaluating the code

```
f x = x + 3
```

replaces all occurrences of `f` followed by a number (`f`'s argument) with that number plus three.

Mathematics also uses the equals sign in an important and subtly different way. For instance, consider this simple problem:

Example: Solve the following equation:

$$x + 3 = 5$$

Our interest here isn't about representing the value 5 as $x + 3$, or vice-versa. Instead, we read the $x + 3 = 5$ equation as a *proposition* that some number x gives 5 as result when added to 3. Solving the equation means finding which, if any, values of x make that proposition true. In this example, elementary algebra tells us that $x = 2$ (i.e. 2 is the number that will make the equation true, giving $2 + 3 = 5$).

Comparing values to see if they are equal is also useful in programming. In Haskell, such tests look just like an equation. Since the equals sign is already used for defining things, Haskell uses a *double* equals sign, `==` instead. Enter our proposition above in GHCi:

```
Prelude> 2 + 3 == 5
True
```

GHCi returns "True" because $2 + 3$ is equal to 5. What if we use an equation that is not true?

```
Prelude> 7 + 3 == 5
False
```

Nice and coherent. Next, we will use our own functions in these tests. Let's try the function `f` we mentioned at the start of the chapter:

```
Prelude> let f x = x + 3
Prelude> f 2 == 5
True
```

This works as expected because `f 2` evaluates to `2 + 3`.

We can also compare two numerical values to see which one is larger. Haskell provides a number of tests including: `<` (less than), `>` (greater than), `<=` (less than or equal to) and `>=` (greater than or equal to). These tests work comparably to `==` (equal to). For example, we could use `<` alongside the `area` function from the previous module to see whether a circle of a certain radius would have an area smaller than some value.

```
Prelude> let area r = pi * r ^ 2
Prelude> area 5 < 50
False
```

4.2 Boolean values

What is actually going on when GHCi determines whether these arithmetical propositions are true or false? Consider a different but related issue. If we enter an arithmetical expression in GHCi the expression gets *evaluated*, and the resulting numerical value is displayed on the screen:

```
Prelude> 2 + 2
4
```

If we replace the arithmetical expression with an equality comparison, something similar seems to happen:

```
Prelude> 2 == 2
True
```

Whereas the "4" returned earlier is a number which represents some kind of count, quantity, etc., "True" is a *value* that stands for the truth of a proposition. Such values are called **truth values**, or **boolean values**.¹ Naturally, only two possible boolean values exist: `True` and `False`.

¹ The term is a tribute to the mathematician and philosopher George Boole [^{\{https://en.wikipedia.org/wiki/George%20Boole\}}](https://en.wikipedia.org/wiki/George%20Boole).

4.2.1 Introduction to types

`True` and `False` are real values, not just an analogy. Boolean values have the same status as numerical values in Haskell, and you can manipulate them in similar ways. One trivial example:

```
Prelude> True == True
True
Prelude> True == False
False
```

`True` is indeed equal to `True`, and `True` is not equal to `False`. Now: can you answer whether `2` is equal to `True`?

```
Prelude> 2 == True
<interactive>:1:0:
  No instance for (Num Bool)
    arising from the literal '2' at <interactive>:1:0
  Possible fix: add an instance declaration for (Num Bool)
  In the first argument of '(==)', namely '2'
  In the expression: 2 == True
  In an equation for 'it': it = 2 == True
```

Error! The question just does not make sense. We cannot compare a number with a non-number or a boolean with a non-boolean. Haskell incorporates that notion, and the ugly error message complains about this. Ignoring much of the clutter, the message says that there was a number (`Num`) on the left side of the `==`, and so some kind of number was expected on the right side; however, a boolean value (`Bool`) is not a number, and so the equality test failed.

So, values have **types**, and these types define limits to what we can or cannot do with the values. `True` and `False` are values of type `Bool`. The `2` is complicated because there are many different types of numbers, so we will defer that explanation until later. Overall, types provide great power because they regulate the behavior of values with rules that *make sense*, making it easier to write programs that work correctly. We will come back to the topic of types many times as they are very important to Haskell.

4.3 Infix operators

An equality test like `2 == 2` is an expression just like `2 + 2`; it evaluates to a value in pretty much the same way. The ugly error message we got on the previous example even says so:

```
In the expression: 2 == True
```

When we type `2 == 2` in the prompt and GHCi "answers" `True`, it is simply evaluating an expression. In fact, `==` is itself a function which takes two arguments (which are the left side and the right side of the equality test), but the syntax is notable: Haskell allows two-argument functions to be written as *infix operators* placed *between* their arguments. When the function name uses only non-alphanumeric characters, this infix approach is the common use case. If you wish to use such a function in the "standard" way (writing the function name before the arguments, as a *prefix operator*) the function name must be enclosed in parentheses. So the following expressions are completely equivalent:

```
Prelude> 4 + 9 == 13
True
Prelude> (==) (4 + 9) 13
True
```

Thus, we see how `(==)` works as a function similarly to `areaRect` from the previous module. The same considerations apply to the other *relational operators* we mentioned (`<`, `>`, `<=`, `>=`) and to the arithmetical operators (`+`, `*`, etc.) – all are functions that take two arguments and are normally written as infix operators.

In general, we can say that tangible things in Haskell are either values or functions.

4.4 Boolean operations

Haskell provides three basic functions for further manipulation of truth values as in logic propositions:

- `(&&)` performs the *and* operation. Given two boolean values, it evaluates to `True` if both the first and the second are `True`, and to `False` otherwise.

```
Prelude> (3 < 8) && (False == False)
True
Prelude> (&&) (6 <= 5) (1 == 1)
False
```

- `(||)` performs the *or* operation. Given two boolean values, it evaluates to `True` if either the first or the second are `True` (or if both are true), and to `False` otherwise.

```
Prelude> (2 + 2 == 5) || (2 > 0)
True
Prelude> (||) (18 == 17) (9 >= 11)
False
```

- `not` performs the negation of a boolean value; that is, it converts `True` to `False` and vice-versa.

```
Prelude> not (5 * 2 == 10)
False
```

Haskell libraries already include the relational operator function (`/=`) for *not equal to*, but we could easily implement it ourselves as:

```
x /= y = not (x == y)
```

Note that we can write operators infix even when defining them. Completely new operators can also be created out of ASCII symbols (which means mostly the common symbols used on a keyboard).

4.5 Guards

Haskell programs often use boolean operators in convenient and abbreviated syntax. When the same logic is written in alternative styles, we call this *syntactic sugar* because it sweetens the code from the human perspective. We'll start with *guards*, a feature that relies on boolean values and allows us to write simple but powerful functions.

Let's implement the absolute value function. The absolute value of a real number is the number with its sign discarded; so if the number is negative (that is, smaller than zero) the sign is inverted; otherwise it remains unchanged. We could write the definition as:

$$|x| = \begin{cases} x, & \text{if } x \geq 0 \\ -x, & \text{if } x < 0. \end{cases}$$

Here, the actual expression to be used for calculating $|x|$ depends on a set of propositions made about x . If $x \geq 0$ is true, then we use the first expression, but if $x < 0$ is the case, then we use the second expression instead. To express this decision process in Haskell using guards, the implementation could look like this:²

Example: The absolute value function.

```
absolute x
  | x < 0    = 0 - x
  | otherwise = x
```

Remarkably, the above code is about as readable as the corresponding mathematical definition. Let us dissect the components of the definition:

- We start just like a normal function definition, providing a name for the function, `absolute`, and saying it will take a single argument, which we will name `x`.
- Instead of just following with the `=` and the right-hand side of the definition, we enter the two alternatives placed below on separate lines.³ These alternatives are the *guards* proper. Note that the whitespace (the indentation of the second and third lines) is not just for aesthetic reasons; it is necessary for the code to be parsed correctly.

² This function is already provided by Haskell with the name `abs`, so in a real-world situation you don't need to provide an implementation yourself.

³ We *could* have joined the lines and written everything in a single line, but it would be less readable.

- Each of the guards begins with a pipe character, |. After the pipe, we put an expression which evaluates to a boolean (also called a boolean condition or a *predicate*), which is followed by the rest of the definition. The function only uses the equals sign and the right-hand side from a line if the predicate evaluates to `True`.
- The `otherwise` case is used when none of the preceding predicates evaluate to `True`. In this case, if `x` is not smaller than zero, it must be greater than or equal to zero, so the final predicate could have just as easily been `x >= 0`; but `otherwise` works just as well.

Note:

There is no syntactical magic behind `otherwise`. It is defined alongside the default variables and functions of Haskell as simply

```
otherwise = True
```

This definition makes `otherwise` a catch-all guard. As evaluation of the guard predicates is sequential, the `otherwise` predicate will only be reached if none of the previous cases evaluate to `True` (so make sure you always place `otherwise` as the last guard!). In general, it is a good idea to always provide an `otherwise` guard, because a rather ugly runtime error will be produced if none of the predicates is true for some input.

Note:

You might wonder why we wrote `0 - x` and not simply `-x` to denote the sign inversion. Well, we could have written the first guard as

```
| x < 0 = -x
```

and that would work, but this way of expressing sign inversion is one of a few "special cases" in Haskell; the `-` is *not* a function that takes one argument and evaluates to `0 - x`, it's a syntactical abbreviation. While very handy, this shortcut occasionally conflicts with the usage of `(-)` as an actual function (the subtraction operator), which is a potential source of annoyance (for example, try writing three minus negative-four without using any parentheses for grouping). So, we wrote `0 - x` explicitly so that we could point out this issue.

4.5.1 where and Guards

`where` clauses work well along with guards. For instance, consider a function which computes the number of (real) solutions for a quadratic equation⁴, $ax^2 + bx + c = 0$:

```
numOfRealSolutions a b c
  | disc > 0 = 2
  | disc == 0 = 1
  | otherwise = 0
  where
    disc = b^2 - 4*a*c
```

The `where` definition is within the scope of all of the guards, sparing us from repeating the expression for `disc`.

⁴ <https://en.wikipedia.org/wiki/Quadratic%20equation>

5 Type basics

In programming, **Types** are used to group similar values into categories. In Haskell, the type system is a powerful way of reducing the number of mistakes in your code.

5.1 Introduction

Programming deals with different sorts of entities. For example, consider adding two numbers together:

$2 + 3$

What are 2 and 3? Well, they are numbers. What about the plus sign in the middle? That's certainly not a number, but it stands for an operation which we can do with two numbers – namely, addition.

Similarly, consider a program that asks you for your name and then greets you with a "Hello" message. Neither your name nor the word Hello are numbers. What are they then? We might refer to all words and sentences and so forth as text. It's normal in programming to use a slightly more esoteric word: *String*, which is short for "string of characters".

Note:

Haskell has a rule that all type names have to begin with a capital letter. We shall adhere to this convention henceforth.

Databases illustrate clearly the concept of types. For example, say we had a table in a database to store details about a person's contacts; a kind of personal telephone book. The contents might look like this:

First Name	Last Name	Address	Telephone number
Sherlock	Holmes	221B Baker Street London	743756
Bob	Jones	99 Long Road Street Villestown	655523

The fields in each entry contain values. **Sherlock** is a value as is **99 Long Road Street Villestown** as well as **655523**. Let's classify the values in this example in terms of types. "First Name" and "Last Name" contain text, so we say that the values are of type String.

At first glance, we might classify address as a String. However, the semantics behind an innocent address are quite complex. Many human conventions dictate how we interpret addresses. For example, if the beginning of the address text contains a number it is likely the number of the house. If not, then it's probably the name of the house – except if it starts with "PO Box", in which case it's just a postal box address and doesn't indicate where the person lives at all. Each part of the address has its own meaning.

In principle, we can indeed say that addresses are Strings, but that doesn't capture many important features of addresses. When we describe something as a String, all that we are saying is that it is a sequence of characters (letters, numbers, etc). Recognizing something as a specialized type is far more meaningful. If we know something is an Address, we instantly know much more about the piece of data – for instance, that we can interpret it using the "human conventions" that give meaning to addresses.

We might also apply this rationale to the telephone numbers. We could specify a TelephoneNumber type. Then, if we were to come across some arbitrary sequence of digits which happened to be of type TelephoneNumber we would have access to a lot more information than if it were just a Number – for instance, we could start looking for things such as area and country codes on the initial digits.

Another reason not to consider the telephone numbers as Numbers is that doing arithmetics with them makes no sense. What is the meaning and expected effect of, say, multiplying a TelephoneNumber by 100? It would not allow calling anyone by phone. Also, each digit comprising a telephone number is important; we cannot accept losing some of them by rounding or even by omitting leading zeros.

5.1.1 Why types are useful

How does it help us program well to describe and categorize things? Once we define a type, we can specify what we can or cannot do with it. That makes it far easier to manage larger programs and avoid errors.

5.2 Using the interactive `:type` command

Let's explore how types work using GHCi. The type of any expression can be checked with `:type` (or shortened to `:t`) command. Try this on the boolean values from the previous module:

Example:

Exploring the types of boolean values in GHCi

```
Prelude> :type True
```

```
True :: Bool
```

```
Prelude> :type False
```

```
False :: Bool
```

```
Prelude> :t (3 < 5)
```

```
(3 < 5) :: Bool
```

The symbol `::`, which will appear in a couple other places, can be read as simply "is of type", and indicates a *type signature*.

`:type` reveals that truth values in Haskell are of type `Bool`, as illustrated above for the two possible values, `True` and `False`, as well as for a sample expression that will evaluate to one of them. Note that boolean values are not just for value comparisons. `Bool` captures the semantics of a yes/no answer, so it can represent any information of such kind – say, whether a name was found in a spreadsheet, or whether a user has toggled an on/off option.

5.2.1 Characters and strings

Now let's try `:t` on something new. Literal characters are entered by enclosing them with single quotation marks. For instance, this is the single letter H:

Example:

Using the `:type` command in GHCi on a literal character

```
Prelude> :t 'H'
```

```
'H' :: Char
```

So, literal character values have type `Char` (short for "character"). Now, single quotation marks only work for individual characters, so if we need to enter longer text – that is, a string of characters – we use *double* quotation marks instead:

Example:

Using the `:t` command in GHCi on a literal string

```
Prelude> :t "Hello World"
```

```
"Hello World" :: [Char]
```

Why did we get `Char` again? The difference is the square brackets. `[Char]` means a number of characters chained together, forming a *list* of characters. Haskell considers all `Strings` to be lists of characters. Lists in general are important entities in Haskell, and we will cover them in more detail in a little while.

Exercises:

1. Try using `:type` on the literal value `"H"` (notice the double quotes). What happens? Why?
2. Try using `:type` on the literal value `'Hello World'` (notice the single quotes). What happens? Why?

Incidentally, Haskell allows for *type synonyms*, which work pretty much like synonyms in human languages (words that mean the same thing – say, 'big' and 'large'). In Haskell, type synonyms are alternative names for types. For instance, `String` is defined as a synonym of `[Char]`, and so we can freely substitute one with the other. Therefore, to say:

```
"Hello World" :: String
```

is also perfectly valid, and in many cases a lot more readable. From here on we'll mostly refer to text values as `String`, rather than `[Char]`.

5.3 Functional types

So far, we have seen how values (strings, booleans, characters, etc.) have types and how these types help us to categorize and describe them. Now, the big twist that makes Haskell's

type system truly powerful: *Functions* have types as well.¹ Let's look at some examples to see how that works.

5.3.1 Example: not

We can negate boolean values with `not` (e.g. `not True` evaluates to `False` and vice-versa). To figure out the type of a function, we consider two things: the type of values it takes as its input and the type of value it returns. In this example, things are easy. `not` takes a `Bool` (the `Bool` to be negated), and returns a `Bool` (the negated `Bool`). The notation for writing that down is:

Example: Type signature for not

```
not :: Bool -> Bool
```

You can read this as "not is a function from things of type `Bool` to things of type `Bool`".

Using `:t` on a function will work just as expected:

```
Prelude> :t not
not :: Bool -> Bool
```

The description of a function's type is in terms of the types of argument(s) it takes and the type of value it evaluates to.

5.3.2 Example: chr and ord

Text presents a problem to computers. At its lowest level, a computer only knows binary 1s and 0s. To represent text, every character is first converted to a number, then that number is converted to binary and stored. That's how a piece of text (which is just a sequence of characters) is encoded into binary. Normally, we're only interested in how to encode characters into their numerical representations, because the computer takes care of the conversion to binary numbers without our intervention.

The easiest way to convert characters to numbers is simply to write all the possible characters down, then number them. For example, we might decide that 'a' corresponds to 1, then 'b' to 2, and so on. This is what something called the ASCII standard is: take 128 commonly-used characters and number them (ASCII doesn't actually start with 'a', but the general idea is the same). Of course, it would be quite a chore to sit down and look up a character in a big lookup table every time we wanted to encode it, so we've got two functions that do it for us, `chr` (pronounced 'char') and `ord`²:

¹ The deeper truth is that functions *are* values, just like all the others.

² This isn't quite what `chr` and `ord` do, but that description fits our purposes well, and it's close enough.

Example: Type signatures for chr and ord

```
chr :: Int -> Char
ord :: Char -> Int
```

We already know what `Char` means. The new type on the signatures above, `Int`, refers to integer numbers, and is one of quite a few different types of numbers.³ The type signature of `chr` tells us that it takes an argument of type `Int`, an integer number, and evaluates to a result of type `Char`. The converse is the case with `ord`: It takes things of type `Char` and returns things of type `Int`. With the info from the type signatures, it becomes immediately clear which of the functions encodes a character into a numeric code (`ord`) and which does the decoding back to a character (`chr`).

To make things more concrete, here are a few examples. Notice that the two functions aren't available by default; so before trying them in GHCi you need to use the `:module Data.Char` (or `:m Data.Char`) command to load the `Data.Char` module where they are defined.

Example:

```
Function calls to <code>chr</code> and <code>ord</code>
Prelude> :m Data.Char
Prelude Data.Char> chr 97
'a'
Prelude Data.Char> chr 98
'b'
Prelude Data.Char> ord 'c'
99
```

5.3.3 Functions with more than one argument

What would be the type of a function that takes more than one argument?

Example: A function with more than one argument

```
xor p q = (p || q) && not (p && q)
```

(`xor` is the exclusive-or function, which evaluates to `True` if either one or the other argument is `True`, *but not both*; and `False` otherwise.)

The general technique for forming the type of a function that accepts more than one argument is simply to write down all the types of the arguments in a row, in order (so in this

³ In fact, it is not even the only type for integers! We will meet its relatives in a short while.

case `p` first then `q`), then link them all with `->`. Finally, add the type of the result to the end of the row and stick a final `->` in just before it.⁴ In this example, we have:

1. Write down the types of the arguments. In this case, the use of `(||)` and `(&&)` gives away that `p` and `q` have to be of type `Bool`:

```
Bool           Bool
^^ p is a Bool   ^^ q is a Bool as well
```

2. Fill in the gaps with `->`:
`Bool -> Bool`
3. Add in the result type and a final `->`. In our case, we're just doing some basic boolean operations so the result remains a `Bool`.

```
Bool -> Bool -> Bool
           ^^ We're returning a Bool
           ^^ This is the extra -> that got added in
```

The final signature, then, is:

Example: The signature of `xor`

```
xor :: Bool -> Bool -> Bool
```

5.3.4 Real world example: `openWindow`

Note:

A library is a collection of common code used by many programs.

As you'll learn in the Haskell in Practice section of the course, one popular group of Haskell libraries are the GUI (**G**raphical **U**ser **I**nterface) ones. These provide functions for dealing with the visual things computer users are familiar with: menus, buttons, application windows, moving the mouse around, etc. One function from one of these libraries is called `openWindow`, and you can use it to open a new window in your application. For example, say you're writing a word processor, and the user has clicked on the 'Options' button. You need to open a new window which contains all the options that they can change. Let's look at the type signature for this function.⁵

Example: `openWindow`

```
openWindow :: WindowTitle -> WindowSize -> Window
```

You don't know these types, but they're quite simple. All three of the types there, `WindowTitle`, `WindowSize` and `Window` are defined by the GUI library that provides `openWindow`. As we saw earlier, the two arrows mean that the first two types are the

⁴ This method might seem just a trivial hack by now, but actually there are very deep reasons behind it, which we'll cover in the chapter on higher-order functions ^{Chapter19 on page 127}.

⁵ This has been somewhat simplified to fit our purposes. Don't worry, the essence of the function is there.

types of the parameters, and the last is the type of the result. `WindowTitle` holds the title of the window (which typically appears in a title bar at the very top of the window), and `WindowSize` specifies how big the window should be. The function then returns a value of type `Window` which represents the actual window.

So, even if you have never seen a function before or don't know how it actually works, a type signature can give you a general idea of what the function does. Make a habit of testing every new function you meet with `:t`. If you start doing that now, you'll not only learn about the standard library Haskell functions but also develop a useful kind of intuition about functions in Haskell.

Exercises:

What are the types of the following functions? For any functions involving numbers, you can just pretend the numbers are `Ints`.

1. The `negate` function, which takes an `Int` and returns that `Int` with its sign swapped. For example, `negate 4 = -4`, and `negate (-2) = 2`
2. The `(||)` function, pronounced 'or', that takes two `Bools` and returns a third `Bool` which is `True` if either of the arguments were, and `False` otherwise.
3. A `monthLength` function which takes a `Bool` which is `True` if we are considering a leap year and `False` otherwise, and an `Int` which is the number of a month; and returns another `Int` which is the number of days in that month.
4. `f x y = not x && y`
5. `g x = (2*x - 1)^2`

5.4 Type signatures in code

We have explored the basic theory behind types and how they apply to Haskell. Now, we will see how type signatures are used for annotating functions in source files. Consider the `xor` function from an earlier example:

Example: A function with its signature

```
xor :: Bool -> Bool -> Bool
xor p q = (p || q) && not (p && q)
```

That is all we have to do. For maximum clarity, type signatures go above the corresponding function definition.

The signatures we add in this way serve a dual role: they clarify the type of the functions both to human readers and to the compiler/interpreter.

5.4.1 Type inference

If type signatures tell the interpreter (or compiler) about the function type, how did we write our earliest Haskell code without type signatures? Well, when you don't tell Haskell the types of your functions and variables it figures them out through a process called *type*

inference. In essence, the compiler starts with the types of things it knows and then works out the types of the rest of the values. Consider a general example:

Example: Simple type inference

```
-- We're deliberately not providing a type signature for this function
isL c = c == 'l'
```

`isL` is a function that takes an argument `c` and returns the result of evaluating `c == 'l'`. Without a type signature, the type of `c` and the type of the result are not specified. In the expression `c == 'l'`, however, the compiler knows that `'l'` is a `Char`. Since `c` and `'l'` are being compared with equality with `(==)` and both arguments of `(==)` must have the same type,⁶ it follows that `c` must be a `Char`. Finally, since `isL c` is the result of `(==)` it must be a `Bool`. And thus we have a signature for the function:

Example: `isL` with a type

```
isL :: Char -> Bool
isL c = c == 'l'
```

Indeed, if you leave out the type signature, the Haskell compiler will discover it through this process. You can verify that by using `:t` on `isL` with or without a signature.

So why write type signatures if they will be inferred anyway? In some cases, the compiler lacks information to infer the type, and so the signature becomes obligatory. In some other cases, we can use a type signature to influence to a certain extent the final type of a function or value. These cases needn't concern us for now, but we have a few other reasons to include type signatures:

- **Documentation:** type signatures make your code easier to read. With most functions, the name of the function along with the type of the function is sufficient to guess what the function does. Of course, commenting your code helps, but having the types clearly stated helps too.
- **Debugging:** when you annotate a function with a type signature and then make a typo in the body of the function which changes the type of a variable, the compiler will tell you, *at compile-time*, that your function is wrong. Leaving off the type signature might allow your erroneous function to compile, and the compiler would assign it the wrong type. You wouldn't know until you ran your program that you made this mistake.

5.4.2 Types and readability

A somewhat more realistic example will help us understand better how signatures can help documentation. The piece of code quoted below is a tiny *module* (modules are the typical

⁶ As discussed in Truth values ^{Chapter4 on page 19}. That fact is actually stated by the type signature of `(==)` – if you are curious you can check it, although you will have to wait a little bit more for a full explanation of the notation used in that.

way of preparing a library), and this way of organizing code is like that in the libraries bundled with GHC.

Note:

Do not go crazy trying to understand how the functions here actually work; that is beside the point as we still have not covered many of the features being used. Just keep reading and play along.

Example: Module with type signatures

```
module StringManip where

import Data.Char

uppercase, lowercase :: String -> String
uppercase = map toUpper
lowercase = map toLower

capitalize :: String -> String
capitalize x =
  let capWord []      = []
      capWord (x:xs) = toUpper x : xs
  in unwords (map capWord (words x))
```

This tiny library provides three string manipulation functions. `uppercase` converts a string to upper case, `lowercase` to lower case, and `capitalize` capitalizes the first letter of every word. Each of these functions takes a `String` as argument and evaluates to another `String`. Even if we do not understand how these functions work, looking at the type signatures allows us to immediately know the types of the arguments and return values. Paired with sensible function names, we have enough information to figure out how we can use the functions.

Note that when functions have the same type we have the option of writing just one signature for all of them, by separating their names with commas, as above with `uppercase` and `lowercase`.

5.4.3 Types prevent errors

The role of types in preventing errors is central to typed languages. When passing expressions around you have to make sure the types match up like they did here. If they don't, you'll get *type errors* when you try to compile; your program won't pass the *typecheck*. This helps reduce bugs in your programs. To take a very trivial example:

Example: A non-typechecking program

```
"hello" + " world"    -- type error
```

That line will cause a program to fail when compiling. You can't add two strings together. In all likelihood, the programmer intended to use the similar-looking concatenation operator, which can be used to join two strings together into a single one:

Example: Our erroneous program, fixed

```
"hello" ++ " world"    -- "hello world"
```

An easy typo to make, but Haskell catches the error when you tried to compile. You don't have to wait until you run the program for the bug to become apparent.

Updating a program commonly involves changes to types. If a change is unintended, or has unforeseen consequences, then it will show up when compiling. Haskell programmers often remark that once they have fixed all the type errors, and their programs compile, that they tend to "just work". The behavior may not always match the intention, but the program won't crash. Haskell has far fewer *run-time errors* (where your program goes wrong when you run it rather than when you compile) than other languages.

6 Lists and tuples

Haskell uses two fundamental structures for managing several values: lists and tuples. They both work by grouping multiple values into a single combined value.

6.1 Lists

Let's build some lists in GHCi:

```
Prelude> let numbers = [1,2,3,4]
Prelude> let truths  = [True, False, False]
Prelude> let strings = ["here", "are", "some", "strings"]
```

The square brackets delimit the list, and individual elements are separated by commas. The only important restriction is that all elements in a list must be of the same type. Trying to define a list with mixed-type elements results in a typical type error:

```
Prelude> let mixed = [True, "bonjour"]

<interactive>:1:19:
  Couldn't match `Bool' against `[Char]'
    Expected type: Bool
    Inferred type: [Char]
    In the list element: "bonjour"
    In the definition of `mixed': mixed = [True, "bonjour"]
```

6.1.1 Building lists

In addition to specifying the whole list at once using square brackets and commas, you can build them up piece by piece using the `(:)` operator pronounced "cons". The process of building up a list this way is often referred to as **consing**. This terminology comes from LISP programmers who invented the verb "to cons" (a mnemonic for "constructor") to refer to this specific task of prepending an element to a list.

Example:

```
Consing something on to a list
Prelude> let numbers = [1,2,3,4]
Prelude> numbers
[1,2,3,4]
Prelude> 0:numbers
[0,1,2,3,4]
```

When you cons something on to a list (`something:someList`), you get back another list. Thus, you can keep on consing for as long as you wish. Note that the cons operator evaluates from right to left. Another (more general) way to think of it is that it takes the first value to its left and the whole expression to its right.

Example:

```
Consing lots of things to a list
Prelude> 1:0:numbers
[1,0,1,2,3,4]
Prelude> 2:1:0:numbers
[2,1,0,1,2,3,4]
Prelude> 5:4:3:2:1:0:numbers
[5,4,3,2,1,0,1,2,3,4]
```

In fact, Haskell builds all lists this way by consing all elements to the *empty list*, `[]`. The commas-and-brackets notation are just *syntactic sugar*. So `[1,2,3,4,5]` is exactly equivalent to `1:2:3:4:5:[]`

You will, however, want to watch out for a potential pitfall in list construction. Whereas `True:False:[]` is perfectly good Haskell, `True:False` is *not*:

Example:

```
Whoops!
Prelude> True:False

<interactive>:1:5:
  Couldn't match '[Bool]' against 'Bool'
    Expected type: [Bool]
    Inferred type: Bool
  In the second argument of '(:)', namely 'False'
  In the definition of 'it': it = True : False
```

`True:False` produces a familiar-looking type error message. It tells us that the `cons` operator `(:)` (which is really just a function) expected a list as its second argument, but we gave it another `Bool` instead. `(:)` only knows how to stick things onto lists.¹

So, when using `cons`, remember:

- The elements of the list must have the same type.
- You can only `cons (:) something` onto a list, not the other way around (you cannot `cons` a list onto an element). So, the final item on the right must be a list, and the items on the left must be independent elements, not lists.

Exercises:

1. Would the following piece of Haskell work: `3:[True,False]`? Why or why not?
2. Write a function `cons8` that takes a list as an argument and conses 8 (at the beginning) on to it. Test it out on the following lists by doing:
 - a) `cons8 []`
 - b) `cons8 [1,2,3]`
 - c) `cons8 [True,False]`
 - d) `let foo = cons8 [1,2,3]`
`cons8 foo`
3. Adapt the above function in a way that 8 is at the end of the list. (Hint: recall the concatenation operator `++` from the previous chapter.)
4. Write a function that takes two arguments, a list and a thing, and conses the thing onto the list. You can start out with:

```
let myCons list thing =
```

6.1.2 Strings are just lists

As we briefly mentioned in the Type Basics module, strings in Haskell are just lists of characters. That means values of type `String` can be manipulated just like any other list. For instance, instead of entering strings directly as a sequence of characters enclosed in double quotation marks, they may also be constructed through a sequence of `Char` values, either linked with `(:)` and terminated by an empty list or using the commas-and-brackets notation.

```
Prelude>"hey" == ['h','e','y']
True
Prelude>"hey" == 'h':'e':'y':[]
True
```

Using double-quoted strings is just more syntactic sugar.

¹ At this point you might question the value of types. While they can feel annoying at first, more often than not they turn out to be extremely helpful. In any case, when you are programming in Haskell and something blows up, you'll probably want to think "type error".

6.1.3 Lists of lists

Lists can contain *anything* — as long as they are all of the same type. Because lists are things too, lists can contain other lists! Try the following in the interpreter:

Example:

Lists can contain lists

```
Prelude> let listOfLists = [[1,2],[3,4],[5,6]]
```

```
Prelude> listOfLists
```

```
[[1,2],[3,4],[5,6]]
```

Lists of lists can be tricky sometimes because a list of things does not have the same type as a thing all by itself. The type `Int` is different from `[Int]`. Let's sort through these implications with a few exercises:

Exercises:

1. Which of these are valid Haskell and which are not? Rewrite in cons notation.
 - a) `[1,2,3,[]]`
 - b) `[1,[2,3],4]`
 - c) `[[1,2,3],[]]`
2. Which of these are valid Haskell, and which are not? Rewrite in comma and bracket notation.
 - a) `[] : [[1,2,3],[4,5,6]]`
 - b) `[] : []`
 - c) `[] : [] : []`
 - d) `[1] : [] : []`
 - e) `["hi"] : [1] : []`
3. Can Haskell have lists of lists of lists? Why or why not?
4. Why is the following list invalid in Haskell?
 - a) `[[1,2],3,[4,5]]`

Lists of different types of things cannot be consed, but the empty list can be consed with lists of anything. For example, `[] : [[1, 2], [1, 2, 3]]` is valid and will produce `[[], [1, 2], [1, 2, 3]]`, and `[1] : [[1, 2], [1, 2, 3]]` is valid and will produce `[[1], [1, 2], [1, 2, 3]]`, but `['a'] : [[1, 2], [1, 2, 3]]` will produce an error message.

Lists of lists allow us to express some kinds of complicated, structured data (two-dimensional matrices, for example). They are also one of the places where the Haskell type system truly shines. Human programmers (including this wikibook co-author) get confused *all* the time when working with lists of lists, and having restrictions on types often helps in wading through the potential mess.

6.2 Tuples

6.2.1 A different notion of many

Tuples offer another way of storing multiple values in a single value. Tuples and lists have two key differences:

- Tuples have a *fixed* number of elements (*immutable*); you can't cons to a tuple. Therefore, it makes sense to use tuples when you *know* in advance how many values are to be stored. For example, we might want a type for storing 2D coordinates of a point. We know exactly how many values we need for each point (two – the *x* and *y* coordinates), so tuples are applicable.
- The elements of a tuple do not need to be all of the same type. For instance, in a phonebook application we might want to handle the entries by crunching three values into one: the name, phone number, and the number of times we made calls. In such a case the three values won't have the same type, since the name and the phone number are strings, but contact counter will be a number, so lists wouldn't work.

Tuples are marked by parentheses with elements delimited by commas. Let's look at some sample tuples:

Example: Some tuples

```
(True, 1)
("Hello world", False)
(4, 5, "Six", True, 'b')
```

The first example is a tuple containing two elements: True and 1. The next example again has two elements: "Hello world" and False. The third example is a tuple consisting of *five* elements: 4 (a number), 5 (another number), "Six" (a string), True (a boolean value), and 'b' (a character).

A quick note on nomenclature: In general you use *n-tuple* to denote a tuple of size *n*. Commonly, we call 2-tuples (that is, tuples with 2 elements) *pairs* and 3-tuples *triples*. Tuples of greater sizes aren't actually all that common, but we can logically extend the naming system to *quadruples*, *quintuples*, and so on.

Exercises:

1. Write down the 3-tuple whose first element is 4, second element is "hello" and third element is True.
2. Which of the following are valid tuples?
 - a) (4, 4)
 - b) (4, "hello")
 - c) (True, "Blah", "foo")
 - d) ()
3. Lists can be built by consing new elements onto them. Cons a number onto a list of numbers, you will get back a list of numbers. There is no such way to build up tuples.
 - a) Why do you think that is?
 - b) For the sake of argument, say that there was such a function. What would you get if you "consed" something on a tuple?

Tuples are handy when you want to return more than one value from a function. In many languages, returning two or more things at once often requires wrapping them up in a single-purpose data structure, maybe one that only gets used in that function. In Haskell, we would return such results as a tuple.

6.2.2 Tuples within tuples (and other combinations)

We can apply the same reasoning to tuples about storing lists within lists. Tuples are things too, so you can store tuples within tuples (within tuples up to any arbitrary level of complexity). Likewise, you could also have lists of tuples, tuples of lists, and all sorts of related combinations.

Example: Nesting tuples and lists

```
((2,3), True)
((2,3), [2,3])
[(1,2), (3,4), (5,6)]
```

The type of a tuple is defined not only by its size, but, like lists, by the types of objects it contains. For example, the tuples ("Hello",32) and (47,"World") are fundamentally different. One is of type (String,Int), whereas the other is (Int,String). This has implications for building up lists of tuples. We could very well have lists like [("a",1),("b",9),("c",9)], but Haskell cannot have a list like [("a",1), (2,"b"), (9,"c")].

Exercises:

1. Which of these are valid Haskell, and why?
 - `1:(2,3)`
 - `(2,4):(2,3)`
 - `(2,4):[]`
 - `[(2,4),(5,5),('a','b')]`
 - `([2,4],[2,2])`

6.3 Retrieving values

For lists and tuples to be useful, we will need to access the internal values they contain.

Let's begin with pairs (i.e. 2-tuples) representing the (x, y) coordinates of a point. Imagine you want to specify a specific square on a chess board. You could label the ranks and files from 1 to 8. Then, a pair $(2, 5)$ could represent the square in rank 2 and file 5. Say we want a function for finding all the pieces in a given rank. We could start with the coordinates of all the pieces and then look at the rank part and see whether it equals whatever row we want to examine. Given a coordinate pair (x, y) of a piece, our function would need to extract the x (the rank coordinate). For this sort of goal, there are two standard functions, `fst` and `snd`, that retrieve² the first and second elements out of a pair, respectively. Let's see some examples:

Example:

```
Using <code>fst</code> and <code>snd</code>
Prelude> fst (2, 5)
2
Prelude> fst (True, "boo")
True
Prelude> snd (5, "Hello")
"Hello"
```

Note that these functions, by definition, *only* work on pairs.³

For lists, the functions `head` and `tail` are *roughly* analogous to `fst` and `snd`. They disassemble a list by taking apart what `(:)` joined. `head` evaluates to the first element of the list, while `tail` gives the rest of the list.

² Or, more technically, "... *projections* that *project* the elements..." In math-speak, a function that gets some data out of a structure is called a projection.

³ Yes, a function could be designed to extract the first thing from any size tuple, but it wouldn't be as simple as you might think, and it isn't how the `fst` and `snd` functions from the standard libraries work.

Example:

```
Using <code>head</code> and <code>tail</code>
Prelude> 2:[7,5,0]
[2,7,5,0]
Prelude> head [2,7,5,0]
2
Prelude> tail [2,7,5,0]
[7,5,0]
```

Note:

Unfortunately, we have a serious problem with `head` and `tail`. If we apply either of them to an empty list...

```
Prelude> head []
• • • Exception: Prelude.head: empty list
```

... it blows up, as an empty list has no first element, nor any other elements at all. Outside of GHCi, attempting to run `head` or `tail` on the empty list will crash a program. We will play with `head` and `tail` for the moment, but we want to avoid any risk of such malfunctions in our real code, so we will learn later about better options. One might ask "What is the problem? Using `head` and `tail` works fine if we are careful and never pass them an empty list, or if we somehow test whether a list is empty before calling them." But that way lies madness.

As programs get bigger and more complicated, the number of places in which an empty list could end up being passed to `head` and `tail` grows quickly as does the number of places in which we might make a mistake. As a rule of thumb, you should avoid functions that might fail without warning. As we advance through the book, we will learn better ways to avoid these risks.

6.3.1 Pending questions

The four functions introduced here do not appear to fully solve the problem we started this section with. While `fst` and `snd` provide a satisfactory solution for pairs, what about tuples with three or more elements? And with lists, can we do any better than just breaking them after the first element? For the moment, we will have to leave these questions pending. Once we do some necessary groundwork, we will return to this subject in future chapters on list manipulation. For now, know that separating head and tail of a list will allow us to do anything we want.

Exercises:

1. Use a combination of `fst` and `snd` to extract the 4 from the tuple `(("Hello", 4), True)`.
2. Normal chess notation is somewhat different to ours: it numbers the rows from 1-8 and the columns a-h; and the column label is customarily given first. Could we label a specific point with a character and a number, like `('a', 4)`? What important difference with lists does this illustrate?
3. Write a function which returns the head and the tail of a list as the first and second elements of a tuple.
4. Use `head` and `tail` to write a function which gives the fifth element of a list. Then, make a critique of it, pointing out any annoyances and pitfalls you notice.

6.4 Polymorphic types

Recall that the type of a list depends on the types of its elements and is denoted by enclosing it in square brackets:

```
Prelude>:t [True, False]
[True, False] :: [Bool]
Prelude>:t ["hey", "my"]
["hey", "my"] :: Char4
```

Lists of `Bool` are a different type than lists of `[Char]` (which is the same as a list of `String` because `[Char]` and `String` are synonyms). Since functions only accept arguments of the types specified in the type of the function, that might lead to some complications. For example, consider the case of `head`. Given that `[Int]`, `[Bool]` and `[String]` are different types, it seems we would need separate functions for every case – `headInt :: [Int] -> Int`, `headBool :: [Bool] -> Bool`, `headString :: [String] -> String`, and so on... That, however, would be not only very annoying but also rather senseless. After all, lists are assembled in the same way regardless of the types of the values they contain, and so we would expect the procedure to get the first element of the list would remain the same in all cases.

Fortunately, we do have a single function `head`, which works on all lists:

```
Prelude> head [True, False]
True
Prelude> head ["hey", "my"]
"hey"
```

How can that possibly work? As usual, checking the type of `head` provides a good hint:

Example:

```
Our first polymorphic type
Prelude>:t head
head :: [a] -> a
```

The `a` in the signature is *not* a type – remember that type names always start with uppercase letters. Instead, it is a **type variable**. When Haskell sees a type variable, it allows any type to take its place. In type theory (a branch of mathematics), this is called *polymorphism*: functions or values with only a single type are called *monomorphic*, and things that use type variables to admit more than one type are *polymorphic*. The type of `head`, for instance, tells us that it takes a list (`[a]`) of values of an arbitrary type (`a`) and gives back a value of that same type (`a`).

Note that within a single type signature, all cases of the same type variable must be of the same type. For example,

```
f :: a -> a
```

means that `f` takes an argument of *any* type and gives something of the *same* type as the result, as opposed to

```
f :: a -> b
```

which means that `f` takes an argument of *any* type and gives a result of *any* type which *may or may not* match the type of whatever we have for `a`. The different type variables do not specify that the types must be different, it only says that they can be different.

6.4.1 Example: `fst` and `snd`

As we saw, you can use the `fst` and `snd` functions to extract parts of pairs. By now, you should already be building the habit of wondering "what type is this?" for every function you come across. Let's consider the cases of `fst` and `snd`. These two functions take a pair as their argument and return one element of this pair. As with lists, the type of a pair depends on the type of its elements, so the functions need to be polymorphic. Also remember that pairs (and tuples in general) don't have to be homogeneous with respect to internal types. So if we were to say:

```
fst :: (a, a) -> a
```

That would mean `fst` would only work if the first and second part of the pair given as input had the same type. So the correct type is:

Example: The types of `fst` and `snd`

```
fst :: (a, b) -> a
snd :: (a, b) -> b
```

If you knew nothing about `fst` and `snd` other than the type signatures, you might still guess that they return the first and second parts of a pair, respectively. Although that is correct, other functions may have this same type signature. All the signatures say is that they just have to return something *with the same type* as the first and second parts of the pair.

Exercises:

Give type signatures for the following functions:

1. The solution to the third exercise of the previous section ("... a function which returns the head and the tail of a list as the first and second elements of a tuple").
2. The solution to the fourth exercise of the previous section ("... a function which gives the fifth element of a list").
3. `h x y z = chr (x - 2)` (remember we discussed `chr` in the previous chapter).

6.5 Summary

This chapter introduced lists and tuples. The key similarities and differences between them are:

1. Lists are defined by square brackets and commas : `[1,2,3]`.
 - Lists can contain *anything* as long as all the elements of the list are of the same type.
 - Lists can also be built by the cons operator, `(:)`, but you can only cons things onto lists.
2. Tuples are defined by parentheses and commas : `("Bob",32)`
 - Tuples can contain *anything*, even things of different types.
 - The length of a tuple is encoded in its type; tuples with different lengths will have different types.
3. Lists and tuples can be combined in any number of ways: lists within lists, tuples within lists, etc, but their criteria must still be fulfilled for the combinations to be valid.

7 Type basics II

In this chapter, we will show how numerical types are handled in Haskell and introduce some important features of the type system. Before diving into the text, though, pause for a moment and consider the following question: what should be the type of the function (+)?¹

7.1 The Num class

Mathematics puts few restrictions on the kinds of numbers we can add together. Consider, for instance, $2 + 3$ (two natural numbers), $(-7) + 5.12$ (a negative integer and a rational number), or $\frac{1}{7} + \pi$ (a rational and an irrational). All of these are valid. In fact, any two real numbers can be added together. In order to capture such generality in the simplest way possible we need a general `Number` type in Haskell, so that the signature of (+) would be simply

```
(+) :: Number -> Number -> Number
```

However, that design fits poorly with the way computers perform arithmetic. While computers can handle integers as a sequence of binary digits in memory, that approach does not work for real numbers,² thus making a more complicated encoding necessary for dealing with them: floating point numbers³. While floating point provides a reasonable way to deal with real numbers in general, it has some inconveniences (most notably, loss of precision) which makes using the simpler encoding worthwhile for integer values. So, we have at least two different ways of storing numbers: one for integers and another for general real numbers. Each approach should correspond to different Haskell types. Furthermore, computers are only able to perform operations like (+) on a pair of numbers if they are in the same format.

So much for having a universal `Number` type – it seems that we can't even have (+) mix integers and floating-point numbers. However, Haskell *can* at least use the same (+) function with either integers or floating point numbers. Check this yourself in GHCi:

```
Prelude>3 + 4
7
Prelude>4.34 + 3.12
```

- 1 If you followed our recommendations in "Type basics", chances are you have already seen the rather exotic answer by testing with `:t...` if that is the case, consider the following analysis as a path to understanding the meaning of that signature.
- 2 Among other issues, between any two real numbers there are uncountably many real numbers – and that fact can't be directly mapped into a representation in memory no matter what we do.
- 3 <https://en.wikipedia.org/wiki/Floating%20point>

7.46

When discussing lists and tuples, we saw that functions can accept arguments of different types if they are made *polymorphic*. In that spirit, here's a possible type signature for (+) that would account for the facts above:

```
(+) :: a -> a -> a
```

With that type signature, (+) would take two arguments of the same type `a` (which could be integers or floating-point numbers) and evaluate to a result of type `a` (as long as both arguments are the same type). But this type signature indicates *any* type at all, and we know that we can't use (+) with two `Bool` values, or two `Char` values. What would adding two letters or two truth-values mean? So, the *actual* type signature of (+) uses a language feature that allows us to express the semantic restriction that `a` can be any type *as long as it is a number type*:

```
(+) :: (Num a) => a -> a -> a
```

`Num` is a **typeclass** — a group of types which includes all types which are regarded as numbers.⁴ The `(Num a) =>` part of the signature restricts `a` to number types – or, in Haskell terminology, *instances* of `Num`.

7.2 Numeric types

So, which are the *actual* number types (that is, the instances of `Num` that the `a` in the signature may stand for)? The most important numeric types are `Int`, `Integer` and `Double`:

- `Int` corresponds to the plain integer type found in most languages. It has fixed maximum and minimum values that depend on a computer's processor. (In 32-bit machines the range goes from -2147483648 to 2147483647).
- `Integer` also is used for integer numbers, but it supports arbitrarily large values – at the cost of some efficiency.
- `Double` is the double-precision floating point type, a good choice for real numbers in the vast majority of cases. (Haskell also has `Float`, the single-precision counterpart of `Double`, which is usually less attractive due to further loss of precision.)

Several other number types are available, but these cover most in everyday tasks.

7.2.1 Polymorphic guesswork

If you've read carefully this far, you know that we don't need to specify types always because the compiler can *infer* types. You also know that we cannot mix types when functions require matched types. Combine this with our new understanding of numbers to understand how Haskell handles basic arithmetic like this:

⁴ This is a loose definition, but will suffice until we discuss typeclasses in more detail.

```
Prelude> (-7) + 5.12
-1.88
```

This may seem to add two numbers of different types – an integer and a non-integer. Let's see what the types of the numbers we entered actually are:

```
Prelude> :t (-7)
(-7) :: (Num a) => a
```

So, `(-7)` is neither `Int` nor `Integer`! Rather, it is a *polymorphic* value, which can "morph" into any number type. Now, let's look at the other number:

```
Prelude> :t 5.12
5.12 :: (Fractional t) => t
```

`5.12` is also a polymorphic value, but one of the `Fractional` class, which is a subset of `Num` (every `Fractional` is a `Num`, but not every `Num` is a `Fractional`; for instance, `Ints` and `Integers` are not `Fractional`).

When a Haskell program evaluates `(-7) + 5.12`, it must settle for an actual matching type for the numbers. The type inference accounts for the class specifications: `(-7)` can be any `Num`, but there are extra restrictions for `5.12`, so that's the limiting factor. With no other restrictions, `5.12` will assume the default `Fractional` type of `Double`, so `(-7)` will become a `Double` as well. Addition then proceeds normally and returns a `Double`.⁵⁶

The following test will give you a better feel of this process. In a source file, define

```
x = 2
```

Then load the file in GHCi and check the type of `x`. Then, change the file to add a `y` variable,

```
x = 2
y = x + 3
```

reload it and check the types of `x` and `y`. Finally, modify `y` to

```
x = 2
y = x + 3.1
```

and see what happens with the types of both variables.

5 For seasoned programmers:

6 This appears to have the same effect that programs in C (and many other languages) manage with an *implicit cast* (where an integer literal is silently converted to a double). In C, however, the conversion is done behind your back, while in Haskell it only occurs if the variable/literal is a polymorphic value. This distinction will become clearer shortly, when we show a counter-example.

7.2.2 Monomorphic trouble

The sophistication of the numerical types and classes occasionally leads to some complications. Consider, for instance, the common division operator (`/`). It has the following type signature:

```
(/) :: (Fractional a) => a -> a -> a
```

Restricting `a` to fractional types is a must because the division of two integer numbers will often result in a non-integer. Nevertheless, we can still write something like

```
Prelude> 4 / 3
1.3333333333333333
```

because the literals `4` and `3` are polymorphic values and therefore assume the type `Double` at the behest of `(/)`. Suppose, however, we want to divide a number by the number of elements in a list.⁷ The obvious thing to do would be using the `length` function, which takes a list and gives the number of elements in it:

```
Prelude> length [1,2,3]
3
Prelude> 4 / length [1,2,3]
```

Unfortunately, that blows up:

```
<interactive>:1:0:
  No instance for (Fractional Int)
    arising from a use of `/' at <interactive>:1:0-17
  Possible fix: add an instance declaration for (Fractional Int)
  In the expression: 4 / length [1, 2, 3]
  In the definition of `it': it = 4 / length [1, 2, 3]
```

As usual, the problem can be understood by looking at the type signature of `length`:

```
length :: (Foldable t) => t a -> Int
```

For now, let's focus on the type of the result of `length`. It is `Int`; the result is not polymorphic. As an `Int` is not a `Fractional`, Haskell won't let us use it with `(/)`.

To escape this problem, we have a special function. Before following on with the text, try to guess what this does only from the name and signature:

```
fromIntegral :: (Integral a, Num b) => a -> b
```

⁷ A reasonable scenario – think of computing an average of the values in a list.

`fromIntegral` takes an argument of some `Integral` type (like `Int` or `Integer`) and makes it a polymorphic value. By combining it with `length`, we can make the length of the list fit into the signature of `(/)`:

```
Prelude> 4 / fromIntegral (length [1,2,3])
1.3333333333333333
```

In some ways, this issue is annoying and tedious, but it is an inevitable side-effect of having a rigorous approach to manipulating numbers. In Haskell, if you define a function with an `Int` argument, it will never be converted to an `Integer` or `Double`, unless you explicitly use a function like `fromIntegral`. As a direct consequence of its refined type system, Haskell has a surprising diversity of classes and functions dealing with numbers.

7.3 Classes beyond numbers

Haskell has typeclasses beyond arithmetic. For example, the type signature of `(==)` is:

```
(==) :: (Eq a) => a -> a -> Bool
```

Like `(+)` or `(/)`, `(==)` is a polymorphic function. It compares two values of the same type, which must belong to the class `Eq` and returns a `Bool`. `Eq` is simply the class for types of values which can be compared for equality, and it includes all of the basic non-functional types.⁸

A quite different example of a typeclass that we have glossed over has appeared in the type of `length`. Given that `length` takes a list and gives back an `Int`, we might have expected its type to be:

```
length :: [a] -> Int
```

The actual type, however, is a little trickier:

```
length :: (Foldable t) => t a -> Int
```

Beyond lists, there are other kinds of structures that can be used to group values in different ways. Many of these structures belong, together with lists themselves, to a typeclass called `Foldable`. The type signature of `length` tells us that it works not only with lists, but also with all those other `Foldable` structures. Later in the book, we will see examples of such structures, and discuss `Foldable` in detail. Until then, whenever you see something like `Foldable t => t a` in a type signature, feel free to mentally replace that with `[a]`.

Typeclasses add a lot to the power of the type system. We will return to this topic later to see how to use them in custom ways.

⁸ Comparing two functions for equality is considered intractable

8 Building vocabulary

This chapter will be a bit of an interlude with some advice for studying and using Haskell. We will discuss the importance of acquiring a vocabulary of functions and how this book and other resources can help. First, however, we need to understand function composition.

8.1 Function composition

Function composition means applying one function to a value and then applying another function to the result. Consider these two functions:

Example: Simple functions

```
f x = x + 3
square x = x ^ 2
```

We can compose them in two different ways, depending on which one we apply first:

```
Prelude> square (f 1)
16
Prelude> square (f 2)
25
Prelude> f (square 1)
4
Prelude> f (square 2)
7
```

The parentheses around the inner function are necessary; otherwise, the interpreter would think that you were trying to get the value of `square f`, or `f square`; and both of those would give type errors.

The composition of two functions results in a function in its own right. If we regularly apply `f` and then `square` (or vice-versa), we should generate a new variable name for the resulting combinations:

Example: Composed functions

```
squareOfF x = square (f x)

fOfSquare x = f (square x)
```

There is a second, nifty way of writing composed functions. It uses `(.)`, the function composition operator and is as simple as putting a period between the two functions:

Example: Composing functions with `(.)`

```
squareOfF x = (square . f) x
```

```
fOfSquare x = (f . square) x
```

Note that functions are still applied from right to left, so that $g(f(x)) == (g . f) x$. `(.)` is modeled after the mathematical operator \circ , which works in the same way: $(g \circ f)(x) = g(f(x))$.

Incidentally, our function definitions *are* effectively mathematical equations, so we can take

```
squareOfF x = (square . f) x
```

and cancel the `x` from both sides, leaving:

```
squareOfF = square . f
```

We will later learn more about such cases of functions without arguments shown. For now, understand we can simply substitute our defined variable name for any case of the composed functions.

8.2 The need for a vocabulary

Haskell makes it simple to write composed functions and to define variables, so we end up with relatively simple, elegant, and expressive code. Of course, to use function composition, we first need to have functions to compose. While functions we write ourselves will always be available, every installation of GHC comes with a vast assortment of libraries (i.e. packaged code), which provide functions for many common tasks. For that reason, effective Haskell programmers need some familiarity with the essential libraries. At the least, you should know how to find useful functions in the libraries when you need them.

Given only the Haskell syntax we will cover through the Recursion¹ chapter, we will, in principle, have enough knowledge to write nearly any list manipulation program we want. However, writing full programs with only these basics would be terribly inefficient because we would end up rewriting large parts of the standard libraries. So, much of our study going forward will involve studying and understanding these valuable tools the Haskell community has already built.

8.3 Prelude and the libraries

Here are a few basic facts about Haskell libraries:

¹ Chapter 12 on page 79

First and foremost, *Prelude* is the core library loaded by default in every Haskell program. Alongside with the basic types, it provides a set of ubiquitous and useful functions. We will refer to Prelude and its functions all the time throughout these introductory chapters.

GHC includes a large set of core libraries that provide a wide range of tools, but only Prelude is loaded automatically. The other libraries are available as *modules* which you can *import* into your program. Later on, we will explain the minutiae of how modules work. For now, just know that your source file needs lines near the top to import any desired modules. For example, to use the function `permutations` from the module `Data.List`, add the line `import Data.List` to the top of your `.hs` file. Here's a full source file example:

Example: Importing a module in a source file

```
import Data.List

testPermutations = permutations "Prelude"
```

For quick GHCi tests, just enter `:m +Data.List` at the command line to load that module.

```
Prelude> :m +Data.List
Prelude Data.List> :t permutations
permutations :: [a] -> a2
```

8.4 One exhibit

Before continuing, let us see one (slightly histrionic, we admit) example of what familiarity with a few basic functions from Prelude can bring us.³ Suppose we need a function which takes a string composed of words separated by spaces and returns that string with the order of the words reversed, so that "Mary had a little lamb" becomes "lamb little a had Mary". We *could* solve this problem using only the basics we have already covered along with a few insights in the upcoming Recursion chapter. Below is one messy, complicated solution. Don't stare at it for too long!

³ The example here is inspired by the Simple Unix tools ^{http://www.haskell.org/haskellwiki/Simple_unix_tools} demo in the HaskellWiki.

Example: There be dragons

```

monsterRevWords :: String -> String
monsterRevWords input = rejoinUnreversed (divideReversed input)

  where
    divideReversed s = go1 [] s

      where
        go1 divided [] = divided
        go1 [] (c:cs)
          | testSpace c = go1 [] cs
          | otherwise   = go1 [[]] (c:cs)
        go1 (w:ws) [c]
          | testSpace c = (w:ws)
          | otherwise   = ((c:w):ws)
        go1 (w:ws) (c:c':cs)
          | testSpace c =
              if testSpace c'
                then go1 (w:ws) (c':cs)
                else go1 ([c']:w:ws) cs
          | otherwise = go1 ((c:w):ws) (c':cs)
    testSpace c = c == ' '
    rejoinUnreversed [] = []
    rejoinUnreversed [w] = reverseList w
    rejoinUnreversed strings = go2 (' ' : reverseList newFirstWord) (otherWords)

      where
        (newFirstWord : otherWords) = reverseList strings
        go2 rejoined ([]:[]) = rejoined
        go2 rejoined ([]:(w':ws')) = go2 (rejoined) ((' ' :w'):ws')
        go2 rejoined ((c:cs):ws) = go2 (c:rejoined) (cs:ws)
    reverseList [] = []
    reverseList w = go3 [] w

      where
        go3 rev [] = rev
        go3 rev (c:cs) = go3 (c:rev) cs

```

There are too many problems with this *thing*; so let us consider just three of them:

- To see whether `monsterRevWords` does what you expect, you could either take our word for it, test it exhaustively on all sorts of possible inputs, or attempt to understand it and get an awful headache (please don't).
- Furthermore, if we write a function this ugly and have to fix a bug or slightly modify it later on,⁴ we are set for an awful time.
- Finally, we have at least one easy-to-spot potential problem: if you have another glance at the definition, about halfway down there is a `testSpace` helper function which checks

⁴ *Co-author's note:* "Later on? I wrote that half an hour ago, and I'm not totally sure about how it works already..."

if a character is a space or not. The test, however, only includes the common space character (that is, ' '), and no other whitespace characters (tabs, newlines, etc.).⁵

We can do much better than the junk above if we use the following Prelude functions:

- `words`, which reliably breaks down a string in whitespace delimited words, returning a list of strings;
- `reverse`, which reverses a list (incidentally, that is exactly what the `reverseList` above does); and
- `unwords`, which does the opposite of `words`;

then function composition means our problem is instantly solved.

Example: `revWords` done the Haskell way

```
revWords :: String -> String
revWords input = (unwords . reverse . words) input
```

That's short, simple, readable and (since Prelude is reliable) bug-free.⁶ So, any time some program you are writing begins to look like `monsterRevWords`, look around and reach for your toolbox — the libraries.

8.5 This book's use of the libraries

After the stern warnings above, you might expect us to continue diving deep into the standard libraries. However, the Beginner's Track is meant to cover Haskell functionality in a conceptual, readable, and reasonably compact manner. A systematic study of the libraries would not help us, but we will introduce functions from the libraries as appropriate to each concept we cover.

- In the Elementary Haskell section, several of the exercises (mainly, among those about list processing) involve writing equivalent definitions for Prelude functions. For each of these exercises you do, one more function will be added to your repertoire.
- Every now and then we will introduce more library functions; maybe within an example, or just with a mention in passing. Whenever we do so, take a minute to test the function and do some experiments. Remember to extend that habitual curiosity about types we mentioned in Type basics⁷ to the functions themselves.
- While the first few chapters are quite tightly-knit, later parts of the book are more independent. Haskell in Practice includes chapters on the Hierarchical libraries⁸, and most of their content can be understood soon after having completed Elementary Haskell.

⁵ A reliable way of checking whether a character is whitespace is with the `isSpace` function, which is in the module `Data.Char`.

⁶ In case you are wondering, many other functions from Prelude or `Data.List` could help to make `monsterRevWords` somewhat saner — to name a few: `(++)`, `concat`, `groupBy`, `intersperse` — but no use of those would compare to the one-liner above.

⁷ Chapter 5 on page 25

⁸ <https://en.wikibooks.org/wiki/..%2FHierarchical%20libraries>

- As we reach the later parts of the Beginner's track, the concepts we will discuss (monads in particular) will naturally lead to exploration of important parts of the core libraries.

8.6 Other resources

- First and foremost, all modules have basic documentation. You may not be ready to read that directly yet, but we'll get there. You can read the Prelude specification⁹ on-line as well as the documentation of the libraries bundled with GHC¹⁰, with nice navigation and source code just one click away.
- Hoogle¹¹ is a great way to search through the documentation. It is a Haskell search engine which covers the core libraries. You can search for everything from function names to type definitions and more.
- Beyond the libraries included with GHC, there is a large ecosystem of libraries, made available through Hackage¹² and installable with a tool called cabal¹³. The Hackage site has documentation for its libraries. We will not venture outside of the core libraries in the Beginner's Track, but you should certainly use Hackage once you begin your own projects. A second Haskell search engine called Hayoo!¹⁴ covers all of Hackage.
- When appropriate, we will give pointers to other useful learning resources, especially when we move towards intermediate and advanced topics.

9 <http://www.haskell.org/onlinereport/standard-prelude.html>

10 <http://www.haskell.org/ghc/docs/latest/html/libraries/index.html>

11 <http://www.haskell.org/hoogle>

12 <https://hackage.haskell.org/>

13 <http://www.haskell.org/cabal/users-guide/>

14 <http://holubus.fh-wedel.de/hayoo/hayoo.html>

9 Next steps

This chapter introduces *pattern matching* and two new pieces of syntax: `if` expressions and `let` bindings.

9.1 if / then / else

Haskell syntax supports garden-variety conditional expressions of the form *if... then... else ...*. For instance, consider a function that returns `(-1)` if its argument is less than `0`; `0` if its argument *is* `0`; and `1` if its argument is greater than `0`. The predefined `signum` function does that job already; but for the sake of illustration, let's define a version of our own:

Example: The `signum` function.

```
mySignum x =
  if x < 0
  then -1
  else if x > 0
  then 1
  else 0
```

You can experiment with this:

- `Main> mySignum 5 1`
- `Main> mySignum 0 0`
- `Main> mySignum (5 - 10) -1`
- `Main> mySignum (-1) -1`

The parentheses around `"-1"` in the last example are required; if missing, Haskell will think that you are trying to subtract `1` from `mySignum` (which would give a type error).

In an `if/then/else` construct, first the condition (in this case `x < 0`) is evaluated. If it results `True`, the whole construct evaluates to the `then` expression; otherwise (if the condition is `False`), the construct evaluates to the `else` expression. All of that is pretty intuitive. If you have programmed in an imperative language before, however, it might seem surprising to know that Haskell always requires *both* a `then` *and* an `else` clause. The construct has to result in a value in both cases and, specifically, a value of the same type in both cases.

Function definitions using `if / then / else` like the one above can be rewritten using `Guards`¹.

¹ Chapter 4.5 on page 23

Example: From if to guards

```
mySignum x
  | x < 0    = -1
  | x > 0    = 1
  | otherwise = 0
```

Similarly, the absolute value function defined in Truth values² can be rendered with an if/then/else:

Example: From guards to if

```
absolute x =
  if x < 0
    then -x
    else x
```

Why use if/then/else versus guards? As you will see with later examples and in your own programming, either way of handling conditionals may be more readable or convenient depending on the circumstances. In many cases, both options work equally well.

9.2 Introducing pattern matching

Consider a program which tracks statistics from a racing competition in which racers receive points based on their classification in each race, the scoring rules being:

- 10 points for the winner;
- 6 for second-placed;
- 4 for third-placed;
- 3 for fourth-placed;
- 2 for fifth-placed;
- 1 for sixth-placed;
- no points for other racers.

We can write a simple function which takes a classification (represented by an integer number: 1 for first place, etc.³) and returns how many points were earned. One possible solution uses if/then/else:

2 Chapter 4.5 on page 23

3 Here we will not be much worried about what happens if a nonsensical value (say, (-4)) is passed to the function. In general, however, it is a good idea to give some thought to such "strange" cases, in order to avoid nasty surprises down the road.

Example: Computing points with if/then/else

```
pts :: Int -> Int
pts x =
  if x == 1
  then 10
  else if x == 2
  then 6
  else if x == 3
  then 4
  else if x == 4
  then 3
  else if x == 5
  then 2
  else if x == 6
  then 1
  else 0
```

Yuck! Admittedly, it wouldn't look this hideous had we used guards instead of if/then/else, but it still would be tedious to write (and read!) all those equality tests. We can do better, though:

Example: Computing points with a piece-wise definition

```
pts :: Int -> Int
pts 1 = 10
pts 2 = 6
pts 3 = 4
pts 4 = 3
pts 5 = 2
pts 6 = 1
pts _ = 0
```

Much better. However, even though defining `pts` in this style (which we will arbitrarily call *piece-wise definition* from now on) shows to a reader of the code what the function does in a clear way, the syntax looks odd given what we have seen of Haskell so far. Why are there seven equations for `pts`? What are those numbers doing in their left-hand sides? What about variable arguments?

This feature of Haskell is called *pattern matching*. When we call `pts`, the argument is *matched* against the numbers on the left side of each of the equations, which in turn are the *patterns*. The matching is done in the order we wrote the equations. First, the argument is matched against the 1 in the first equation. If the argument is indeed 1, we have a match and the first equation is used; so `pts 1` evaluates to 10 as expected. Otherwise, the other equations are tried in order following the same procedure. The final one, though, is rather different: the `_` is a special pattern, often called a "wildcard", that might be read as

”whatever”: it matches with anything; and therefore if the argument doesn't match any of the previous patterns `pts` will return zero.

As for the lack of `x` or any other variable standing for the argument, we simply don't need that to write the definitions. All possible return values are constants. Besides, variables are used to express relationships on the right side of the definition, so the `x` is unnecessary in our `pts` function.

However, we could use a variable to make `pts` even more concise. The points given to a racer decrease regularly from third place to sixth place, at a rate of one point per position. After noticing that, we can eliminate three of the seven equations as follows:

Example: Mixing styles

```
pts :: Int -> Int
pts 1 = 10
pts 2 = 6
pts x
  | x <= 6    = 7 - x
  | otherwise = 0
```

So, we can mix both styles of definitions. In fact, when we write `pts x` in the left side of an equation we are using pattern matching too! As a pattern, the `x` (or any other variable name) matches anything just like `_`; the only difference being that it also gives us a name to use on the right side (which, in this case, is necessary to write `7 - x`).

Exercises:

We cheated a little when moving from the second version of `pts` to the third one: they do not do exactly the same thing. Can you spot what the difference is?

Beyond integers, pattern matching works with values of various other types. One handy example is booleans. For instance, the `(||)` logical-or operator we met in Truth values⁴ could be defined as:

Example: `(||)`

```
(||) :: Bool -> Bool -> Bool
False || False = False
_      || _     = True
```

Or:

⁴ Chapter 4.5.1 on page 24

Example: (`||`), done another way

```
(||) :: Bool -> Bool -> Bool
True || _ = True
False || y = y
```

When matching two or more arguments at once, the equation will only be used if all of them match.

Now, let's discuss a few things that might go wrong when using pattern matching:

- If we put a pattern which matches anything (such as the final patterns in each of the `pts` example) *before* the more specific ones the latter will be ignored. GHC(i) will typically warn us that "Pattern match(es) are overlapped" in such cases.
- If no patterns match, an error will be triggered. Generally, it is a good idea to ensure the patterns cover all cases, in the same way that the `otherwise` guard is not mandatory but highly recommended.
- Finally, while you can play around with various ways of (re)defining (`&&`),⁵ here is one version that will *not* work:

```
(&&) :: Bool -> Bool -> Bool
x && x = x -- oops!
_ && _ = False
```

The program won't test whether the arguments are equal just because we happened to use the same name for both. As far as the matching goes, we could just as well have written `_ && _` in the first case. And even worse: because we gave the same name to both arguments, GHC(i) will refuse the function due to "Conflicting definitions for 'x'".

9.3 Tuple and list patterns

While the examples above show that pattern matching helps in writing more elegant code, that does not explain why it is so important. So, let's consider the problem of writing a definition for `fst`, the function which extracts the first element of a pair. At this point, that appears to be an impossible task, as the only way of accessing the first value of the pair is by using `fst` itself... The following function, however, does the same thing as `fst` (confirm it in GHCi):

Example: A definition for `fst`

```
fst' :: (a, b) -> a
fst' (x, _) = x
```

It's magic! Instead of using a regular variable in the left side of the equation, we specified the argument with the *pattern* of the 2-tuple - that is, `(,)` - filled with a variable and the

⁵ If you are going to experiment with it in GHCi, call your version something else to avoid a name clash; say, `(&!&)`.

`_` pattern. Then the variable was automatically associated with the first component of the tuple, and we used it to write the right side of the equation. The definition of `snd` is, of course, analogous.

Furthermore, the trick demonstrated above can be done with lists as well. Here are the actual definitions of `head` and `tail`:

Example: head, tail and patterns

```
head      :: [a] -> a
head (x:_) = x
head []    = error "Prelude.head: empty list"

tail     :: [a] -> [a]
tail (_:xs) = xs
tail []    = error "Prelude.tail: empty list"
```

The only essential change in relation to the previous example was replacing `(,)` with the pattern of the cons operator `(:)`. These functions also have an equation using the pattern of the empty list, `[]`; however, since empty lists have no head or tail there is nothing to do other than use `error` to print a prettier error message.

In summary, the power of pattern matching comes from its use in accessing the parts of a complex value. Pattern matching on lists, in particular, will be extensively deployed in *Recursion*⁶ and the chapters that follow it. Later on, we will explore what is happening behind this seemingly magical feature.

9.4 let bindings

To conclude this chapter, a brief word about `let` bindings (an alternative to `where` clauses for making local declarations). For instance, take the problem of finding the roots of a polynomial of the form $ax^2 + bx + c$ (in other words, the solution to a second degree equation — think back to your middle school math courses). Its solutions are given by:

$$x = \frac{-b \pm \sqrt{b^2 - 4ac}}{2a}$$

We could write the following function to compute the two values of x :

```
roots a b c =
  ((-b + sqrt(b * b - 4 * a * c)) / (2 * a),
   (-b - sqrt(b * b - 4 * a * c)) / (2 * a))
```

Writing the `sqrt(b * b - 4 * a * c)` term in both cases is annoying, though; we can use a local binding instead, using either `where` or, as will be demonstrated below, a `let` declaration:

⁶ Chapter 12 on page 79

```
roots a b c =
  let sdisc = sqrt (b * b - 4 * a * c)
  in ((-b + sdisc) / (2 * a),
      (-b - sdisc) / (2 * a))
```

We put the `let` keyword before the declaration, and then use `in` to signal we are returning to the "main" body of the function. It is possible to put multiple declarations inside a single `let...in` block — just make sure they are indented the same amount or there will be syntax errors:

```
roots a b c =
  let sdisc = sqrt (b * b - 4 * a * c)
      twice_a = 2 * a
  in ((-b + sdisc) / twice_a,
      (-b - sdisc) / twice_a)
```



Warning

Because indentation matters syntactically in Haskell, you need to be careful about whether you are using tabs or spaces. By far the best solution is to configure your text editor to insert two or four spaces in place of tabs. If you insist on keeping tabs as distinct, at least ensure that your tabs always have the same length.

Note:

The Indentation^a chapter has a full account of indentation rules.

^a Chapter 23 on page 143

10 Simple input and output

10.1 Back to the real world

Beyond internally calculating values, we want our programs to interact with the world. The most common beginners' program in any language simply displays a "hello world" greeting on the screen. Here's a Haskell version:

```
Prelude> putStrLn "Hello, World!"
```

`putStrLn` is one of the standard Prelude tools. As the "putStr" part of the name suggests, it takes a `String` as an argument and prints it to the screen. We could use `putStr` on its own, but we usually include the "Ln" part so to also print a line break. Thus, whatever else is printed next will appear on a new line.

So now you should be thinking, "what is the type of the `putStrLn` function?" It takes a `String` and gives... um... what? What do we call that? The program doesn't get something back that it can use in another function. Instead, the result involves having the computer change the screen. In other words, it does something in the world outside of the program. What type could that have? Let's see what GHCi tells us:

```
Prelude> :t putStrLn
putStrLn :: String -> IO ()
```

"IO" stands for "input and output". Wherever there is `IO` in a type, interaction with the world outside the program is involved. We'll call these `IO` values *actions*. The other part of the `IO` type, in this case `()`, is the type of the return value of the action; that is, the type of what it gives back to the program (as opposed to what it does outside the program). `()` (pronounced as "unit") is a type that only contains one value also called `()` (effectively a tuple with zero elements). Since `putStrLn` sends output to the world but doesn't return anything to the program, `()` is used as a placeholder. We might read `IO ()` as "action which returns `()`".

A few more examples of when we use `IO`:

- print a string to the screen
- read a string from a keyboard
- write data to a file
- read data from a file

What makes `IO` actually work? Lots of things happen behind the scenes to take us from `putStrLn` to pixels in the screen, but we don't need to understand any of the details to write our programs. A complete Haskell program is actually a big `IO action`. In a compiled program, this action is called `main` and has type `IO ()`. From this point of view, to write a Haskell program is to combine actions and functions to form the overall action `main` that will

be executed when the program is run. The compiler takes care of instructing the computer on how to do this.

Exercises:

Back in the Type Basics chapter, we mentioned that the type of the `openWindow` function^a had been simplified. What do you think its type should actually be?

^a Chapter 5.1.1 on page 26

10.2 Sequencing actions with *do*

`do` notation provides a convenient means of putting actions together (which is essential in doing useful things with Haskell). Consider the following program:

Example: What is your name?

```
main = do
  putStrLn "Please enter your name:"
  name <- getLine
  putStrLn ("Hello, " ++ name ++ ", how are you?")
```

Note:

Even though `do` notation looks very different from the Haskell code we have seen so far, it is just syntactic sugar for a handful of functions, the most important of them being the `(>>=)` operator. We could explain how those functions work and *then* introduce `do` notation. However, there are several topics we would need to cover before we can give a convincing explanation. Jumping in with `do` right now is a pragmatic short cut that will allow you to start writing complete programs with IO right away. We will see how `do` works later in the book, beginning with the [../Understanding monads/^a](#) chapter.

^a Chapter 30 on page 189

Before we get into how `do` works, take a look at `getLine`. It goes to the outside world (to the terminal in this case) and brings back a `String`. What is its type?

```
Prelude> :t getLine
getLine :: IO String
```

That means `getLine` is an IO action that, when run, will return a `String`. But what about the input? While functions have types like `a -> b` which reflect that they take arguments and give back results, `getLine` doesn't actually take an argument. It takes as input whatever is in the line in the terminal. However, that line in the outside world isn't a defined value with a type until we bring it into the Haskell program.

The program doesn't know the state of the outside world until runtime, so it cannot predict the exact results of IO actions. To manage the relationship of these IO actions to other aspects of a program, the actions must be executed in a predictable sequence defined in

advance in the code. With regular functions that do not perform IO, the exact sequencing of execution is less of an issue — as long as the results eventually go to the right places.

In our name program, we're sequencing three actions: a `putStrLn` with a greeting, a `getLine`, and another `putStrLn`. With the `getLine`, we use `<-` notation which assigns a variable name to stand for the returned value. We cannot know what the value will be in advance, but we know it will use the specified variable name, so we can then use the variable elsewhere (in this case, to prepare the final message being printed). The final action defines the type of the whole `do` block. Here, the final action is the result of a `putStrLn`, and so our whole program has type `IO ()`.

Exercises:

Write a program which asks the user for the base and height of a right angled triangle, calculates its area, and prints it to the screen. The interaction should look something like:

```
The base?
3.3
The height?
5.4
The area of that triangle is 8.91
```

You will need to use the function `read` to convert user strings like `"3.3"` into numbers like `3.3` and the function `show` to convert a number into string.

10.2.1 Left arrow clarifications

While actions like `getLine` are almost always used to get values, we are not obliged to actually get them. For example, we could write something like this:

Example: executing `getLine` directly

```
main = do
  putStrLn "Please enter your name:"
  getLine
  putStrLn "Hello, how are you?"
```

In this case, we don't use the input at all, but we still give the user the experience of entering their name. By omitting the `<-`, the action will happen, but the data won't be stored or accessible to the program.

`<-` can be used with any action except the last

There are very few restrictions on which actions can have values obtained from them. Consider the following example where we put the results of each action into a variable (except the last... more on that later):

Example: putting all results into a variable

```
main = do
  x <- putStrLn "Please enter your name:"
  name <- getLine
  putStrLn ("Hello, " ++ name ++ ", how are you?")
```

The variable `x` gets the value out of its action, but that isn't useful in this case because the action returns the unit value `()`. So while we could technically get the value out of any action, it isn't always worth it.

So, what about the final action? Why can't we get a value out of that? Let's see what happens when we try:

Example: getting the value out of the last action

```
main = do
  x <- putStrLn "Please enter your name:"
  name <- getLine
  y <- putStrLn ("Hello, " ++ name ++ ", how are you?")
```

Whoops! Error!

```
HaskellWikibook.hs:5:2:
```

```
    The last statement in a 'do' construct must be an expression
```

Making sense of this requires a somewhat deeper understanding of Haskell than we currently have. Suffice it to say, whenever you use `<-` to get the value of an action, Haskell is always expecting another action to follow it. So the final action cannot have any `<-`s.

10.2.2 Controlling actions

Normal Haskell constructions like **if/then/else** can be used within the **do** notation, but you need to take some care here. For instance, in a simple "guess the number" program, we have:

```
doGuessing num = do
  putStrLn "Enter your guess:"
  guess <- getLine
  if (read guess) < num
    then do putStrLn "Too low!"
            doGuessing num
    else if (read guess) > num
          then do putStrLn "Too high!"
                  doGuessing num
    else putStrLn "You Win!"
```

Remember that the **if/then/else** construction takes three arguments: the condition, the "then" branch, and the "else" branch. The condition needs to have type `Bool`, and the two branches can have any type, provided that they have the *same* type. The type of the entire **if/then/else** construction is then the type of the two branches.

In the outermost comparison, we have `(read guess) < num` as the condition. That has the correct type. Let's now consider the "then" branch. The code here is:

```
do putStrLn "Too low!"
  doGuessing num
```

Here, we are sequencing two actions: `putStrLn` and `doGuessing`. The first has type `IO ()`, which is fine. The second also has type `IO ()`, which is fine. The type result of the entire computation is precisely the type of the final computation. Thus, the type of the "then" branch is also `IO ()`. A similar argument shows that the type of the "else" branch is also `IO ()`. This means the type of the entire **if/then/else** construction is `IO ()`, which is what we want.

Note: be careful if you find yourself thinking, "Well, I already started a `do` block; I don't need another one." We can't have code like:

```
do if (read guess) < num
    then putStrLn "Too low!"
     doGuessing num
    else ...
```

Here, since we didn't repeat the `do`, the compiler doesn't know that the `putStrLn` and `doGuessing` calls are supposed to be sequenced, and the compiler will think you're trying to call `putStrLn` with three arguments: the string, the function `doGuessing` and the integer `num`, and thus reject the program.

Exercises:

Write a program that asks the user for his or her name. If the name is one of Simon, John or Phil, tell the user that you think Haskell is a great programming language. If the name is Koen, tell them that you think debugging Haskell is fun (Koen Classen is one of the people who works on Haskell debugging); otherwise, tell the user that you don't know who he or she is. (As far as syntax goes there are a few different ways to do it; write at least a version using `if / then / else`.)

10.3 Actions under the microscope

Actions may look easy up to now, but they are a common stumbling block for new Haskellers. If you have run into trouble working with actions, see if any of your problems or questions match any of the cases below. We suggest skimming this section now, then come back here when you actually experience trouble.

10.3.1 Mind your action types

One temptation might be to simplify our program for getting a name and printing it back out. Here is one unsuccessful attempt:

Example: Why doesn't this work?

```
main =
  do putStrLn "What is your name? "
     putStrLn ("Hello " ++ getLine)

Ouch! Error!

HaskellWikiBook.hs:3:26:
    Couldn't match expected type `[Char]'
      against inferred type  `IO String'
```

Let us boil the example above down to its simplest form. Would you expect this program to compile?

Example: This still does not work

```
main =
  do putStrLn getLine
```

For the most part, this is the same (attempted) program, except that we've stripped off the superfluous "What is your name" prompt as well as the polite "Hello". One trick to understanding this is to reason about it in terms of types. Let us compare:

```
putStrLn :: String -> IO ()
getLine  :: IO String
```

We can use the same mental machinery we learned in [../Type basics](#)¹ to figure how this went wrong. `putStrLn` is expecting a `String` as input. We do not have a `String`; we have something tantalisingly close: an `IO String`. This represents an action that will *give* us a `String` when it's run. To obtain the `String` that `putStrLn` wants, we need to run the action, and we do that with the ever-handy left arrow, `<-`.

1 Chapter 5 on page 25

Example: This time it works

```
main =
  do name <- getLine
     putStrLn name
```

Working our way back up to the fancy example:

```
main =
  do putStrLn "What is your name? "
     name <- getLine
     putStrLn ("Hello " ++ name)
```

Now the name is the String we are looking for and everything is rolling again.

10.3.2 Mind your expression types too

So, we've made a big deal out of the idea that you can't use actions in situations that don't call for them. The converse of this is that you can't use non-actions in situations that expect actions. Say we want to greet the user, but this time we're so excited to meet them, we just have to SHOUT their name out:

Example: Exciting but incorrect. Why?

```
import Data.Char (toUpper)

main =
  do name <- getLine
     loudName <- makeLoud name
     putStrLn ("Hello " ++ loudName ++ "!")
     putStrLn ("Oh boy! Am I excited to meet you, " ++ loudName)

-- Don't worry too much about this function; it just converts a String to
uppercase
makeLoud :: String -> String
makeLoud s = map toUpper s
```

This goes wrong...

```
Couldn't match expected type `IO' against inferred type `[]'
  Expected type: IO t
  Inferred type: String
  In a 'do' expression: loudName <- makeLoud name
```

This is similar to the problem we ran into above: we've got a mismatch between something expecting an IO type and something which does not produce IO. This time, the trouble is

the left arrow <-; we're trying to left-arrow a value of `makeLoud name`, which really isn't left arrow material. It's basically the same mismatch we saw in the previous section, except now we're trying to use regular old `String` (the loud name) as an `IO String`. The latter is an action, something to be run, whereas the former is just an expression minding its own business. We cannot simply use `loudName = makeLoud name` because a `do` sequences *actions*, and `loudName = makeLoud name` is not an action.

So how do we extricate ourselves from this mess? We have a number of options:

- We could find a way to turn `makeLoud` into an action, to make it return `IO String`. However, we don't want to make actions go out into the world for no reason. Within our program, we can reliably verify how everything is working. When actions engage the outside world, our results are much less predictable. An `IO makeLoud` would be misguided. Consider another issue too: what if we wanted to use `makeLoud` from some other, non-`IO`, function? We really don't want to engage `IO` actions except when absolutely necessary.
- We could use a special code called `return` to promote the loud name into an action, writing something like `loudName <- return (makeLoud name)`. This is slightly better. We at least leave the `makeLoud` function itself nice and `IO`-free whilst using it in an `IO`-compatible fashion. That's still moderately clunky because, by virtue of left arrow, we're implying that there's action to be had -- how exciting! -- only to let our reader down with a somewhat anticlimactic `return` (note: we will learn more about appropriate uses for `return` in later chapters).
- Or we could use a let binding...

It turns out that Haskell has a special extra-convenient syntax for let bindings in actions. It looks a little like this:

Example: let bindings in `do` blocks.

```
main =
  do name <- getLine
     let loudName = makeLoud name
     putStrLn ("Hello " ++ loudName ++ "!")
     putStrLn ("Oh boy! Am I excited to meet you, " ++ loudName)
```

If you're paying attention, you might notice that the let binding above is missing an `in`. This is because `let` bindings inside `do` blocks do not require the `in` keyword. You could very well use it, but then you'd have messy extra `do` blocks. For what it's worth, the following two blocks of code are equivalent.

sweet	unsweet
<pre>do name <- getLine let loudName = makeLoud name putStrLn ("Hello " ++ loudName ++ "!") putStrLn ("Oh boy! Am I excited to meet you, " ++ loudName)</pre>	<pre>do name <- getLine let loudName = makeLoud name in do putStrLn ("Hello " ++ loudName ++ "!") putStrLn ("Oh boy! Am I excited to meet you, " ++ loudName)</pre>

Exercises:

1. Why does the unsweet version of the `let` binding require an extra `do` keyword?
2. Do you always need the extra `do`?
3. (extra credit) Curiously, `let` without `in` is exactly how we wrote things when we were playing with the interpreter in the beginning of this book. Why is it ok to omit the `in` keyword in the interpreter but needed (outside of *do* blocks) in a source file?

10.4 Learn more

At this point, you have the fundamentals needed to do some fancier input/output. Here are some IO-related topics you may want to check in parallel with the main track of this course.

- You could continue the sequential track, learning more about `types`² and eventually `monads`³.
- Alternately: you could start learning about building graphical user interfaces in the `../GUI`/⁴ chapter
- For more IO-related functionality, you could also consider learning more about the `System.IO` library⁵

² Chapter 15 on page 105

³ Chapter 30 on page 189

⁴ Chapter 85 on page 599

⁵ <https://en.wikibooks.org/wiki/..%2FHierarchical%20libraries%2FIO>

11 Elementary Haskell

12 Recursion

Recursive functions play a central role in Haskell, and are used throughout computer science and mathematics generally. **Recursion** is basically a form of repetition, and we can understand it by making distinct what it *means* for a function to be recursive, as compared to how it *behaves*.

A recursive function simply means this: a function that has the ability to invoke itself.

And it behaves such that it invokes itself only when a condition is met, as with an if/else/then expression, or a pattern match which contains at least one *base case* that terminates the recursion, as well as a *recursive case* which causes the function to call itself, creating a loop.

Without a terminating condition, a recursive function may remain in a loop forever, causing an infinite regress.

12.1 Numeric recursion

12.1.1 The factorial function

Mathematics (specifically combinatorics) has a function called **factorial**.¹ It takes a single non-negative integer as an argument, finds all the positive integers less than or equal to “n”, and multiplies them all together. For example, the factorial of 6 (denoted as 6!) is $1 \times 2 \times 3 \times 4 \times 5 \times 6 = 720$. We can use a recursive style to define this in Haskell:

Let's look at the factorials of two adjacent numbers:

Example: Factorials of consecutive numbers

```
Factorial of 6 = 6 × 5 × 4 × 3 × 2 × 1
Factorial of 5 =   5 × 4 × 3 × 2 × 1
```

Notice how we've lined things up. You can see here that the 6! includes the 5!. In fact, 6! is just $6 \times 5!$. Let's continue:

¹ In mathematics, $n!$ normally means the factorial of a non-negative integer n , but that syntax is impossible in Haskell, so we don't use it here.

Example: Factorials of consecutive numbers

```

Factorial of 4 = 4 × 3 × 2 × 1
Factorial of 3 =   3 × 2 × 1
Factorial of 2 =   2 × 1
Factorial of 1 =   1

```

The factorial of any number is just that number multiplied by the factorial of the number one less than it. There's one exception: if we ask for the factorial of 0, we don't want to multiply 0 by the factorial of -1 (factorial is only for positive numbers). In fact, we just say the factorial of 0 is 1 (we *define* it to be so. Just take our word for it that this is right.²). So, 0 is the *base case* for the recursion: when we get to 0 we can immediately say that the answer is 1, no recursion needed. We can summarize the definition of the factorial function as follows:

- The factorial of 0 is 1.
- The factorial of any other number is that number multiplied by the factorial of the number one less than it.

We can translate this directly into Haskell:

Example: Factorial function

```

factorial 0 = 1
factorial n = n * factorial (n - 1)

```

This defines a new function called `factorial`. The first line says that the factorial of 0 is 1, and the second line says that the factorial of any other number `n` is equal to `n` times the factorial of `n - 1`. Note the parentheses around the `n - 1`; without them this would have been parsed as `(factorial n) - 1`; remember that function application (applying a function to a value) takes precedence over anything else when grouping isn't specified otherwise (we say that function application *binds more tightly* than anything else).

Note:

The `factorial` function above is best defined in a file, but since it is a small function, it is feasible to write it in GHCi as a one-liner. To do this, we need to add a semicolon to separate the lines:

```
> let factorial 0 = 1; factorial n = n * factorial (n - 1)
```

Haskell actually uses line separation and other whitespace as a substitute for separation and grouping characters such as semicolons. Haskell programmers generally prefer the clean look of separate lines and appropriate indentation; still, explicit use of semicolons and other markers is always an alternative.

² Actually, defining the factorial of 0 to be 1 is not just arbitrary; it's because the factorial of 0 represents an empty product [^]<https://en.wikipedia.org/wiki/empty%20product> .

The example above demonstrate the simple relationship between factorial of a number, n , and the factorial of a slightly smaller number, $n - 1$.

Think of a function call as delegation. The instructions for a recursive function delegate a sub-task. It just so happens that the delegate function uses the same instructions as the delegator; it's only the input data that changes. The only really confusing thing about recursive functions is the fact that each function call uses the same parameter names, so it can be tricky to keep track of the many delegations.

Let's look at what happens when you execute `factorial 3`:

- 3 isn't 0, so we calculate the factorial of 2
 - 2 isn't 0, so we calculate the factorial of 1
 - 1 isn't 0, so we calculate the factorial of 0
 - 0 *is* 0, so we return 1.
 - To complete the calculation for factorial 1, we multiply the current number, 1, by the factorial of 0, which is 1, obtaining 1 (1×1).
 - To complete the calculation for factorial 2, we multiply the current number, 2, by the factorial of 1, which is 1, obtaining 2 ($2 \times 1 \times 1$).
- To complete the calculation for factorial 3, we multiply the current number, 3, by the factorial of 2, which is 2, obtaining 6 ($3 \times 2 \times 1 \times 1$).

(Note that we end up with the one appearing twice, since the base case is 0 rather than 1; but that's okay since multiplying by 1 has no effect. We could have designed `factorial` to stop at 1 if we had wanted to, but the convention (which is often useful) is to define the factorial of 0.)

When reading or composing recursive functions, you'll rarely need to “unwind” the recursion bit by bit — we leave that to the compiler.

One more note about our recursive definition of `factorial`: the order of the two declarations (one for `factorial 0` and one for `factorial n`) *is* important. Haskell decides which function definition to use by starting at the top and picking the first one that matches. If we had the general case (`factorial n`) before the 'base case' (`factorial 0`), then the general n would match *anything* passed into it – including 0. The compiler would then conclude that `factorial 0` equals $0 * \text{factorial } (-1)$, and so on to negative infinity (clearly not what we want). So, **always list multiple function definitions starting with the most specific and proceeding to the most general.**

Exercises:

1. Type the factorial function into a Haskell source file and load it into GHCi.
2. Try examples like `factorial 5` and `factorial 1000`.^a
 - What about `factorial (-1)`? Why does this happen?
3. The *double factorial* of a number n is the product of *every other* number from 1 (or 2) up to n . For example, the double factorial of 8 is $8 \times 6 \times 4 \times 2 = 384$, and the double factorial of 7 is $7 \times 5 \times 3 \times 1 = 105$. Define a `doublefactorial` function in Haskell.

^a Interestingly, older scientific calculators can't handle things like factorial of 1000 because they run out of memory with that many digits!

12.1.2 Loops, recursion, and accumulating parameters

Imperative languages use *loops* in the same sorts of contexts where Haskell programs use recursion. For example, an idiomatic way of writing a factorial function in C, a typical imperative language, would be using a *for* loop, like this:

Example: The factorial function in an imperative language

```
int factorial(int n) {
    int res = 1;
    for ( ; n > 1; n--)
        res *= n;
    return res;
}
```

Here, the for loop causes `res` to be multiplied by `n` repeatedly. After each repetition, 1 is subtracted from `n` (that is what `n--` does). The repetitions stop when `n` is no longer greater than 1.

A straightforward translation of such a function to Haskell is not possible, since changing the value of the variables `res` and `n` (a destructive update) would not be allowed. However, you can always translate a loop into an equivalent recursive form by making each loop variable into an argument of a recursive function. For example, here is a recursive “translation” of the above loop into Haskell:

Example: Using recursion to simulate a loop

```
factorial n = go n 1
  where
    go n res
      | n > 1    = go (n - 1) (res * n)
      | otherwise = res
```

`go` is an auxiliary function which actually performs the factorial calculation. It takes an extra argument, `res`, which is used as an *accumulating parameter* to build up the final result.

Note:

Depending on the languages you are familiar with, you might have concerns about performance problems caused by recursion. However, compilers for Haskell and other functional programming languages include a number of optimizations for recursion, (not surprising given how often recursion is needed). Also, Haskell is lazy — calculations are only performed once their results are required by other calculations, and that helps to avoid some of the performance problems. We'll discuss such issues and some of the subtleties they involve further in later chapters.

12.1.3 Other recursive functions

As it turns out, there is nothing particularly special about the `factorial` function; a great many numeric functions can be defined recursively in a natural way. For example, let's think about multiplication. When you were first learning multiplication (remember that moment? :)), it may have been through a process of 'repeated addition'. That is, 5×4 is the same as summing four copies of the number 5. Of course, summing four copies of 5 is the same as summing three copies, and then adding one more – that is, $5 \times 4 = 5 \times 3 + 5$. This leads us to a natural recursive definition of multiplication:

Example: Multiplication defined recursively

```
mult _ 0 = 0                -- anything times 0 is zero
mult n m = (mult n (m - 1)) + n -- recurse: multiply by one less, and add an
extra copy
```

Stepping back a bit, we can see how numeric recursion fits into the general recursive pattern. The base case for numeric recursion usually consists of one or more specific numbers (often 0 or 1) for which the answer can be immediately given. The recursive case computes the result by calling the function recursively with a smaller argument and using the result in some manner to produce the final answer. The 'smaller argument' used is often one less than the current argument, leading to recursion which 'walks down the number line' (like the examples of `factorial` and `mult` above). However, the prototypical pattern is not the only possibility; the smaller argument could be produced in some other way as well.

Exercises:

1. Expand out the multiplication 5×4 similarly to the expansion we used above for `factorial 3`.
2. Define a recursive function `power` such that `power x y` raises `x` to the `y` power.
3. You are given a function `plusOne x = x + 1`. Without using any other (+)s, define a recursive function `addition` such that `addition x y` adds `x` and `y` together.
4. (Harder) Implement the function `log2`, which computes the integer log (base 2) of its argument. That is, `log2` computes the exponent of the largest power of 2 which is less than or equal to its argument. For example, `log2 16 = 4`, `log2 11 = 3`, and `log2 1 = 0`. (Small hint: read the last phrase of the paragraph immediately preceding these exercises.)

12.2 List-based recursion

Haskell has many recursive functions, especially concerning lists.³ Consider the `length` function that finds the length of a list:

³ This is no coincidence; without mutable variables, recursion is the only way to implement control structures. This might sound like a limitation until you get used to it.

Example: The recursive definition of length

```
length :: [a] -> Int
length []     = 0
length (x:xs) = 1 + length xs
```

Note:

If you try to load the definition above from a source file, GHCi will complain about an “ambiguous occurrence” when you try to use it, as the Prelude already provides `length`. In that case, just change the name of the function which you are defining to something else. like `length'` or `myLength`.

So, the type signature of `length` tells us that it takes any type of list and produces an `Int`. The next line says that the length of an empty list is 0 (this is the base case). The final line is the recursive case: if a list isn't empty, then it can be broken down into a first element (here called `x`) and the rest of the list (which will just be the empty list if there are no more elements) which will, by convention, be called `xs` (i.e. plural of `x`). The length of the list is 1 (accounting for the `x`) plus the length of `xs` (as in the `tail` example in Next steps⁴, `xs` is set when the argument list matches the `(:)` pattern).

Consider the concatenation function `(++)` which joins two lists together:

Example: The recursive (++)

```
Prelude> [1,2,3] ++ [4,5,6]
[1,2,3,4,5,6]
Prelude> "Hello " ++ "world" -- Strings are lists of Chars
"Hello world"

(++) :: [a] -> [a] -> [a]
[] ++ ys     = ys
(x:xs) ++ ys = x : xs ++ ys
```

This is a little more complicated than `length`. The type says that `(++)` takes two lists of the same type and produces another list of the same type. The base case says that concatenating the empty list with a list `ys` is the same as `ys` itself. Finally, the recursive case breaks the first list into its head (`x`) and tail (`xs`) and says that to concatenate the two lists, concatenate the tail of the first list with the second list, and then tack the head `x` on the front.

There's a pattern here: with list-based functions, the base case usually involves an empty list, and the recursive case involves passing the tail of the list to our function again, so that the list becomes progressively smaller.

4 Chapter 9 on page 59

Exercises:

Give recursive definitions for the following list-based functions. In each case, think what the base case would be, then think what the general case would look like, in terms of everything smaller than it. (Note that all of these functions are available in Prelude, so you will want to give them different names when testing your definitions in GHCi.)

1. `replicate :: Int -> a -> [a]`, which takes a count and an element and returns the list which is that element repeated that many times. E.g. `replicate 3 'a' = "aaa"`. (Hint: think about what replicate of anything with a count of 0 should be; a count of 0 is your 'base case'.)
2. `(!!) :: [a] -> Int -> a`, which returns the element at the given 'index'. The first element is at index 0, the second at index 1, and so on. Note that with this function, you're recursing *both* numerically and down a list^a.
3. (A bit harder.) `zip :: [a] -> [b] -> [(a, b)]`, which takes two lists and 'zips' them together, so that the first pair in the resulting list is the first two elements of the two lists, and so on. E.g. `zip [1,2,3] "abc" = [(1, 'a'), (2, 'b'), (3, 'c')]`. If either of the lists is shorter than the other, you can stop once either list runs out. E.g. `zip [1,2] "abc" = [(1, 'a'), (2, 'b')]`.
4. Define `length` using an auxiliary function and an accumulating parameter, as in the loop-like alternate version of `factorial`.

^a Incidentally, `(!!)` provides a reasonable solution for the problem of the fourth exercise in Lists and tuples/Retrieving values ^{Chapter6.3.1 on page 42}.

Recursion is used to define nearly all functions to do with lists and numbers. The next time you need a list-based algorithm, start with a case for the empty list and a case for the non-empty list and see if your algorithm is recursive.

12.3 Don't get TOO excited about recursion...

Despite its ubiquity in Haskell, one rarely has to write functions that are explicitly recursive. Instead, standard library functions perform recursion for us in various ways. For example, a simpler way to implement the `factorial` function is:

Example: Implementing factorial with a standard library function

```
factorial n = product [1..n]
```

Almost seems like cheating, doesn't it? :) This is the version of `factorial` that most experienced Haskell programmers would write, rather than the explicitly recursive version we started out with. Of course, the `product` function uses some list recursion behind the scenes,⁵ but writing `factorial` in this way means you, the programmer, don't have to worry about it.

⁵ Actually, it uses a function called `foldl` to which it "delegates" the recursion.

13 Lists II

Earlier, we learned that Haskell builds lists via the cons operator (`:`) and the empty list `[]`. We saw how we can work on lists bit by bit using a combination of recursion and pattern matching. In this chapter and the next, we will consider more in-depth techniques for list processing and discover some new notation. We will get our first taste of Haskell features like infinite lists, list comprehensions, and higher-order functions.

Note:

Throughout this chapter, you will read and write functions which sum, subtract, and multiply elements of lists. For simplicity's sake, we will pretend that list elements are of type `Integer`. However, as you will recall from the discussions on Type basics II^a, there are many different types with the `Num` typeclass. As an exercise of sorts, you could figure out what the type signatures of such functions would be if we made them polymorphic, allowing for the list elements to have any type in the class `Num`. To check your signatures, just omit them temporarily, load the functions into GHCi, use `:t` and let type inference guide you.

^a Chapter 7 on page 47

13.1 Rebuilding lists

Here's a function that doubles every element from a list of integers:

```
doubleList :: [Integer] -> [Integer]
doubleList [] = []
doubleList (n:ns) = (2 * n) : doubleList ns
```

Here, the base case is the empty list which evaluates to an empty list. In the recursive case, `doubleList` *builds up a new list* by using `:`. The first element of this new list is twice the head of the argument, and we obtain the rest of the result by recursively calling `doubleList` on the tail of the argument. When the tail gets to an empty list, the base case will be invoked and recursion will stop.¹

Let's study the evaluation of an example expression:

```
doubleList [1,2,3,4]
```

We can work it out longhand by substituting the argument into the function definition, just like schoolbook algebra:

¹ Had we forgotten the base case, once the recursion got to an empty list the `(x:xs)` pattern match would fail, and we would get an error.

```
doubleList 1:[2,3,4] = (1*2) : doubleList (2 : [3,4])
                   = (1*2) : (2*2) : doubleList (3 : [4])
                   = (1*2) : (2*2) : (3*2) : doubleList (4 : [])
                   = (1*2) : (2*2) : (3*2) : (4*2) : doubleList []
                   = (1*2) : (2*2) : (3*2) : (4*2) : []
                   = 2 : 4 : 6 : 8 : []
                   = [2, 4, 6, 8]
```

Thus, we rebuilt the original list replacing every element by its double.

In this longhand evaluation exercise, the *moment* at which we choose to evaluate the multiplications does not affect the result. We could just as well have evaluated the doublings immediately after each recursive call of `doubleList`.²

Haskell uses this flexibility on evaluation order in some important ways. As a *pure* functional programming language, the compiler makes most of the decisions about when to actually evaluate things. As a *lazy* language, Haskell usually defers evaluation until a final value is needed (which may sometimes never occur).³ From the programmer's point of view, evaluation order rarely matters.⁴

13.1.1 Generalizing

To triple each element in a list, we could follow the same strategy as with `doubleList`:

```
tripleList :: [Integer] -> [Integer]
tripleList [] = []
tripleList (n:ns) = (3 * n) : tripleList ns
```

But we don't want to write a new list-multiplying function for every different multiplier (such as multiplying the elements of a list by 4, 8, 17 etc.). So, let's make a general function to allow multiplication by *any* number. Our new function will take two arguments: the multiplicand as well as a list of `Integers` to multiply:

```
multiplyList :: Integer -> [Integer] -> [Integer]
multiplyList _ [] = []
multiplyList m (n:ns) = (m * n) : multiplyList m ns
```

This example deploys `_` as a "don't care" pattern. The multiplicand is not used for the base case, so we ignore that argument instead of giving it a name (like `m`, `n`, or `ns`).

We can test `multiplyList` to see that it works as expected:

```
Prelude> multiplyList 17 [1,2,3,4]
[17,34,51,68]
```

² ...as long as none of the calculations result in an error or nontermination, which are not problems in this case.

³ The compiler may sometimes evaluate things sooner in order to improve efficiency.

⁴ One exception is the case of *infinite lists* (!) which we will consider in a short while.

Exercises:

Write the following functions and test them out. Don't forget the type signatures.

1. `takeInt` returns the first n items in a list. So, `takeInt 4 [11,21,31,41,51,61]` returns `[11,21,31,41]`.
2. `dropInt` drops the first n items in a list and returns the rest. So, `dropInt 3 [11,21,31,41,51]` returns `[41,51]`.
3. `sumInt` returns the sum of the items in a list.
4. `scanSum` adds the items in a list and returns a list of the running totals. So, `scanSum [2,3,4,5]` returns `[2,5,9,14]`.
5. `diffs` returns a list of the differences between adjacent items. So, `diffs [3,5,6,8]` returns `[2,1,2]`. (Hints: one solution involves writing an auxiliary function which takes two lists and calculates the difference between corresponding elements. Alternatively, you might explore the fact that lists with at least two elements can be matched to a `(x:y:ys)` pattern.) The first three functions are in Prelude under the names `take`, `drop`, and `sum`.

13.2 Generalizing even further

In this chapter, we started with a function constrained to multiplying the elements by 2. Then, we recognized that we could avoid hard-coding a new function for each multiplicand by making `multiplyList` to easily use any `Integer`. Now, what if we wanted a different operator such as addition or to compute the square of each element?

We can generalize still further using a key functionality of Haskell. However, because the solution can seem surprising, we will approach it in a somewhat roundabout way. Consider the type signature of `multiplyList`:

```
multiplyList :: Integer -> [Integer] -> [Integer]
```

The first thing to know is that the `->` arrow in type signatures is *right associative*. That means we can read this signature as:

```
multiplyList :: Integer -> ([Integer] -> [Integer])
```

How should we understand that? It tells us that `multiplyList` is a function that takes *one* `Integer` argument and evaluates to *another function*. The function thus returned, then, takes a list of `Integers` and returns another list of `Integers`.

Consider our old `doubleList` function redefined in terms of `multiplyList`:

```
doubleList :: [Integer] -> [Integer]
doubleList xs = multiplyList 2 xs
```

Writing this way, we can clearly cancel out the ‘`xs`’:

```
doubleList = multiplyList 2
```

This definition style (with no argument variables) is called *point-free* style. Our definition now says that applying only one argument to `multiplyList` doesn't fail to evaluate, rather

it gives us a more specific function of type `[Integer] -> [Integer]` instead of finishing with a final `[Integer]` value.

We now see that functions in Haskell behave much like any other value. Functions can return other functions, and functions can stand alone as objects without mentioning their arguments. Functions seem almost like normal constants. Can we use functions themselves as *arguments* even? Yes, and that's the key to the next step in generalizing `multiplyList`. We need a function that takes any other appropriate function and applies the given function to the elements of a list:

```
applyToIntegers :: (Integer -> Integer) -> [Integer] -> [Integer]
applyToIntegers _ [] = []
applyToIntegers f (n:ns) = (f n) : applyToIntegers f ns
```

With `applyToIntegers`, we can take *any* `Integer -> Integer` function and apply it to the elements of a list of `Integers`. We can thus use this generalized function to redefine `multiplyList`:

```
multiplyList :: Integer -> [Integer] -> [Integer]
multiplyList m = applyToIntegers ((*) m)
```

That uses the `(*)` function with a single initial argument to create a new function which is ready to take one more argument (which, in this use case, will come from the numbers in a given list).

13.2.1 Currying

If all this abstraction confuses you, consider a concrete example: When we multiply `5 * 7` in Haskell, the `(*)` function doesn't just take two arguments at once, it actually first takes the 5 and returns a new `5*` function; and that new function *then* takes a second argument and multiplies that by 5. So, for our example, we then give the 7 as an argument to the `5*` function, and *that* returns us our final evaluated number (35).

So, **all functions in Haskell really take only one argument**. However, when we know how many intermediate functions we will generate to reach a final result, we can *treat* functions *as if* they take many arguments. The number of arguments we generally talk about functions taking is actually the number of one-argument functions we get between the first argument and a final, non-functional result value.

The process of creating intermediate functions when feeding arguments into a complex function is called *currying* (named after Haskell Curry, also the namesake of the Haskell programming language).

13.3 The map function

While `applyToIntegers` has type `(Integer -> Integer) -> [Integer] -> [Integer]`, the definition itself contains nothing specific to integers. To use the same logic with other types of lists, we could define versions such as `applyToChars`, `applyToStrings` and so on. They would all have the same definition but different type signatures. We can avoid all that redundancy with the final step in generalizing: making a fully polymorphic version with

signature `(a -> b) -> [a] -> [b]`. Prelude already has this function, and it is called `map`:

```
map :: (a -> b) -> [a] -> [b]
map _ [] = []
map f (x:xs) = (f x) : map f xs
```

With `map`, we can effortlessly implement functions as different as...

```
multiplyList :: Integer -> [Integer] -> [Integer]
multiplyList m = map ((*) m)
```

... and...

```
heads :: [[a]] -> [a]
heads = map head
```

```
Prelude> heads [[1,2,3,4],[4,3,2,1],[5,10,15]]
[1,4,5]
```

`map` is the general solution for applying a function to each and every element of a list. Our original `doubleList` problem was simply a specific version of `map`. Functions like `map` which take other functions as arguments are called *higher-order functions*. We will learn about more higher-order functions for list processing in the next chapter.

Exercises:

- Use `map` to build functions that, given a list `xs` of `Ints`, return:
 - A list that is the element-wise negation of `xs`.
 - A list of lists of `Ints` `xss` that, for each element of `xs`, contains the divisors of `xs`. You can use the following function to get the divisors:

```
divisors p = [ f | f <- [1..p], p `mod` f == 0 ]
```
 - The element-wise negation of `xss`.
- Implement a Run Length Encoding (RLE) encoder and decoder.
 - The idea of RLE is simple; given some input:

```
"aaaabbaaa"
```

 compress it by taking the length of each run of characters: `(4, 'a')`, `(2, 'b')`, `(3, 'a')`
 - The `concat` and `group` functions might be helpful. In order to use `group`, import the `Data.List` module by typing `:m Data.List` at the `ghci` prompt or by adding `import Data.List` to your Haskell source code file.
 - What is the type of your `encode` and `decode` functions?

13.4 Tips and Tricks

A few miscellaneous notes about lists in Haskell:

13.4.1 Dot Dot Notation

Haskell has a convenient shorthand for writing ordered lists of regularly-spaced integers. Some examples to illustrate it:

<u>Code</u>	<u>Result</u>
[1..10]	[1,2,3,4,5,6,7,8,9,10]
[2,4..10]	[2,4,6,8,10]
[5,4..1]	[5,4,3,2,1]
[1,3..10]	[1,3,5,7,9]

The same notation works with characters and even with floating point numbers. Unfortunately, floating-point numbers are problematic due to rounding errors. Try this:

```
[0,0.1 .. 1]
```

Note:

The .. notation *only* works with sequences with fixed differences between consecutive elements. For instance, you cannot write...

```
[0,1,1,2,3,5,8..100]
```

... and expect to magically get back the rest of the Fibonacci series.^a

^a http://en.wikipedia.org/wiki/Fibonacci_number

13.4.2 Infinite Lists

Thanks to lazy evaluation, Haskell lists can be *infinite*. For example, the following generates the infinite list of integers starting with 1:

```
[1..]
```

(If you try this in GHCi, remember you can stop an evaluation with Ctrl-c).

The same effect could be achieved with a recursive function:

```
intsFrom n = n : intsFrom (n + 1) -- note there is no base case!
positiveInts = intsFrom 1
```

Infinite lists are useful in practice because Haskell's lazy evaluation never actually evaluates more than it needs at any given moment. In most cases, we can treat an infinite list like an ordinary one. The program will only go into an infinite loop when evaluation requires all the values in the list. So, we can't sort or print an infinite list, but:

```
evens = doubleList [1..]
```

will define "evens" to be the infinite list [2,4,6,8..], and we can *then* pass "evens" into other functions that only need to evaluate part of the list for their *final* result. Haskell will know to only use the portion of the infinite list needed in the end.

Compared to hard-coding a long finite list, it's often more convenient to define an infinite list and then take the first few items. An infinite list can also be a handy alternative to the traditional endless loop at the top level of an interactive program.

13.4.3 A note about `head` and `tail`

Given the choice of using either the `(:)` pattern or `head/tail` to split lists, pattern matching is almost always preferable. It may be tempting to use `head` and `tail` due to simplicity and terseness, but it is too easy to forget that they fail on empty lists (and runtime crashes are never good). We do have a Prelude function, `null :: [a] -> Bool`, which returns `True` for empty lists and `False` otherwise, so that provides a sane way of checking for empty lists without pattern matching; but matching an empty list tends to be cleaner and clearer than the corresponding if-then-else expression using `null`.

Exercises:

1. With respect to your solutions to the first set of exercises in this chapter, is there any difference between `scanSum (takeInt 10 [1..])` and `takeInt 10 (scanSum [1..])`?
2. Write functions that, when applied to lists, give the *last* element of the list and the list with the last element dropped (without using `reverse`). This functionality is provided by Prelude through the `last` and `init` functions. Like `head` and `tail`, they blow up when given empty lists.

14 Lists III

14.1 Folds

Like `map`, a *fold* is a higher order function that takes a function and a list. However, instead of applying the function element by element, the fold uses it to combine the list elements into a result value.

Let's look at a few concrete examples. `sum` could be implemented as:

Example: sum

```
sum :: [Integer] -> Integer
sum [] = 0
sum (x:xs) = x + sum xs
```

and `product` as:

Example: product

```
product :: [Integer] -> Integer
product [] = 1
product (x:xs) = x * product xs
```

`concat`, which takes a list of lists and joins (concatenates) them into one:

Example: concat

```
concat :: [[a]] -> [a]
concat [] = []
concat (x:xs) = x ++ concat xs
```

All these examples show a pattern of recursion known as a fold. Think of the name referring to a list getting "folded up" into a single value or to a function being "folded between" the elements of the list.

Prelude defines four fold functions: `foldr`, `foldl`, `foldr1` and `foldl1`.

14.1.1 foldr

The *right-associative* `foldr` folds up a list from the right to left. As it proceeds, `foldr` uses the given function to combine each of the elements with the running value called the *accumulator*. When calling `foldr`, the initial value of the accumulator is set as an argument.

```
foldr :: (a -> b -> b) -> b -> [a] -> b
foldr f acc []      = acc
foldr f acc (x:xs) = f x (foldr f acc xs)
```

The first argument to `foldr` is a function with two arguments. The second argument is value for the accumulator (which often starts at a neutral "zero" value). The third argument is the list to be folded.

In `sum`, `f` is `(+)`, and `acc` is `0`. In `concat`, `f` is `(++)` and `acc` is `[]`. In many cases (like all of our examples so far), the function passed to a fold will be one that takes two arguments of the same type, but this is not necessarily the case (as we can see from the `(a -> b -> b)` part of the type signature — if the types *had* to be the same, the first two letters in the type signature would have matched).

Remember, a list in Haskell written as `[a, b, c]` is an alternative (syntactic sugar) style for `a : b : c : []`.

Now, `foldr f acc xs` in the `foldr` definition simply replaces each `cons (:)` in the `xs` list with the function `f` while replacing the empty list at the end with `acc`:

```
foldr f acc (a:b:c:[]) = f a (f b (f c acc))
```

Note how the parentheses nest around the right end of the list.

An elegant visualisation is given by picturing the list data structure as a tree:



We can see here that `foldr (:) []` will return the list completely unchanged. That sort of function that has no effect is called an *identity function*. You should start building a habit of looking for identity functions in different cases, and we'll discuss them more later when we learn about *monoids*.

14.1.2 foldl

The *left-associative* `foldl` processes the list in the opposite direction, starting at the left side with the first element.

```
foldl :: (a -> b -> a) -> a -> [b] -> a
foldl f acc []      = acc
foldl f acc (x:xs) = foldl f (f acc x) xs
```

So, brackets in the resulting expression accumulate around the left end of the list:

```
foldl f acc (a:b:c:[]) = f (f (f acc a) b) c
```

The corresponding trees look like:



Because all folds include both left and right elements, beginners can get confused by the names. You could think of `foldr` as short for fold-right-to-left and `foldl` as fold-left-to-right. The names refer to where the fold starts.

Note:

Technical Note: `foldl` is *tail-recursive*, that is, it recurses immediately, calling itself. For this reason the compiler will optimise it to a simple loop for efficiency. However, Haskell is a lazy language, so the calls to `f` will be left unevaluated by default, thus building up an unevaluated expression in memory that includes the entire length of the list. To avoid running out of memory, we have a version of `foldl` called `foldl'` that is *strict* — it forces the evaluation of `f` immediately at each step.

An apostrophe at the end of a function name is pronounced "tick" as in "fold-L-tick". A tick is a valid character in Haskell identifiers. `foldl'` can be found in the `Data.List` library module (imported by adding `import Data.List` to the beginning of a source file). As a rule of thumb, you should use `foldr` on lists that might be infinite or where the fold is building up a data structure and use `foldl'` if the list is known to be finite and comes down to a single value. There is almost never a good reason to use `foldl` (without the tick), though it might just work if the lists fed to it are not too long.

14.1.3 Are foldl and foldr opposites?

You may notice that in some cases `foldl` and `foldr` do *not* appear to be opposites. Let's examine one such case, involving subtraction as the combining operation. Will we get `True` or `False` for each of the equalities below?

```
foldl (-) 6 [3, 2, 1] == 6 - 3 - 2 - 1
foldr (-) 6 [1, 2, 3] == 6 - 3 - 2 - 1
```

Thinking of `foldr` as going from right to left might lead us to suppose that the second equality would be true, as the rightmost elements show up before the leftmost ones. That, however, is not what we actually see:

```
GHCi> foldl (-) 6 [3, 2, 1] == 6 - 3 - 2 - 1
True
GHCi> foldr (-) 6 [1, 2, 3] == 6 - 3 - 2 - 1
False
```

This happens because the difference between `foldr` and `foldl` lies in the way the resulting expression is associated, and not in the left-to-right order of the elements of the list. Here is the expansion of the expressions above, with explicit parentheses:

```
foldl (-) 6 [3, 2, 1] == ((6 - 3) - 2) - 1 -- True
foldr (-) 6 [1, 2, 3] == 1 - (2 - (3 - 6)) -- True
```

Also note how the initial accumulator (6 in this example) is always found in the innermost parentheses.

For the sake of contrast, here is a simulated imperative style that does change the order of the elements in the list: ¹

```
GHCi> import Data.List -- So that we can give foldl' a try
GHCi> reduce      f acc list = foldl' f acc list -- This is the same as plain
  old foldl'
GHCi> reduceRight f acc list = foldl' f acc (reverse list) -- keep foldl', but
  reverse list
```

Now we get `True` in both cases from our initial example, because both are folding from the left:

```
GHCi> reduce      (-) 6 [3, 2, 1] == 6 - 3 - 2 - 1
True
GHCi> reduceRight (-) 6 [1, 2, 3] == 6 - 3 - 2 - 1
True
```

14.1.4 foldr1 and foldl1

As previously noted, the type declaration for `foldr` makes it quite possible for the list elements and result to be of different types. For example, "read" is a function that takes a string and converts it into some type (the type system is smart enough to figure out which one). In this case we convert it into a float.

Example: The list elements and results can have different types

```
addStr :: String -> Float -> Float
addStr str x = read str + x

sumStr :: [String] -> Float
sumStr = foldr addStr 0.0
```

There is also a variant called `foldr1` ("fold - R - one") which dispenses with an explicit "zero" for an accumulator by taking the last element of the list instead:

```
foldr1      :: (a -> a -> a) -> [a] -> a
foldr1 f [x]      = x
foldr1 f (x:xs)   = f x (foldr1 f xs)
foldr1 _ []       = error "Prelude.foldr1: empty list"
```

¹ The `reduce` and `reduceRight` functions are taken from JavaScript, and they behave in this manner.

And `foldl1` as well:

```
foldl1      :: (a -> a -> a) -> [a] -> a
foldl1 f (x:xs) = foldl f x xs
foldl1 _ []     = error "Prelude.foldl1: empty list"
```

Note: Just like for `foldl`, the `Data.List` library includes `foldl1'` as a strict version of `foldl1`.

With `foldl1` and `foldr1`, all the types have to be the same, and an empty list is an error. These variants are useful when there is no obvious candidate for the initial accumulator value and we are sure that the list is not going to be empty. When in doubt, stick with `foldr` or `foldl'`.

14.1.5 folds and laziness

One reason that right-associative folds are more natural in Haskell than left-associative ones is that right folds can operate on infinite lists. A fold that returns an infinite list is perfectly usable in a larger context that doesn't need to access the entire infinite result. In that case, `foldr` can move along as much as needed and the compiler will know when to stop. However, a left fold necessarily calls itself recursively until it reaches the end of the input list (because the recursive call is not made in an argument to `f`). Needless to say, no end will be reached if an input list to `foldl` is infinite.

As a toy example, consider a function `echoes` that takes a list of integers and produces a list such that wherever the number `n` occurs in the input list, it is replicated `n` times in the output list. To create our `echoes` function, we will use the prelude function `replicate` in which `replicate n x` is a list of length `n` with `x` the value of every element.

We can write `echoes` as a `foldr` quite handily:

```
echoes = foldr (\ x xs -> (replicate x x) ++ xs) []
take 10 (echoes [1..])    -- [1,2,2,3,3,3,4,4,4,4]
```

(*Note:* This definition is compact thanks to the `\ x xs ->` syntax. The `\`, meant to look like a lambda (λ), works as an *unnamed* function for cases where we won't use the function again anywhere else. Thus, we provide the definition of our one-time function *in situ*. In this case, `x` and `xs` are the arguments, and the right-hand side of the definition is what comes after the `->`.)

We could have instead used a `foldl`:

```
echoes = foldl (\ xs x -> xs ++ (replicate x x)) []
take 10 (echoes [1..])    -- not terminating
```

but only the `foldr` version works on an infinite lists. What would happen if you just evaluate `echoes [1..]`? Try it! (If you try this in GHCi or a terminal, remember you can stop an evaluation with Ctrl-c, but you have to be quick and keep an eye on the system monitor or your memory will be consumed in no time and your system will hang.)

As a final example, `map` itself can be implemented as a fold:

```
map f = foldr (\ x xs -> f x : xs) []
```

Folding takes some time to get used to, but it is a fundamental pattern in functional programming and eventually becomes very natural. Any time you want to traverse a list and build up a result from its members, you likely want a fold.

Exercises:

1. Define the following functions recursively (like the definitions for `sum`, `product` and `concat` above), then turn them into a fold:
 - `and :: [Bool] -> Bool`, which returns `True` if a list of `Bools` are all `True`, and `False` otherwise.
 - `or :: [Bool] -> Bool`, which returns `True` if any of a list of `Bools` are `True`, and `False` otherwise.
2. Define the following functions using `foldl1` or `foldr1`:
 - `maximum :: Ord a => [a] -> a`, which returns the maximum element of a list (hint: `max :: Ord a => a -> a -> a` returns the maximum of two values).
 - `minimum :: Ord a => [a] -> a`, which returns the minimum element of a list (hint: `min :: Ord a => a -> a -> a` returns the minimum of two values).
3. Use a fold (*which one?*) to define `reverse :: [a] -> [a]`, which returns a list with the elements in reverse order.

Note that all of these are Prelude functions, so they will be always close at hand when you need them. (Also, that means you must use slightly different names in order to test your answers in GHCi.)

14.2 Scans

A "scan" is like a cross between a `map` and a fold. Folding a list accumulates a single return value, whereas mapping puts each item through a function returning a separate result for each item. A scan does both: it accumulates a value like a fold, but instead of returning only a final value it returns a list of all the intermediate values.

Prelude contains four scan functions:

```
scanl :: (a -> b -> a) -> a -> [b] -> [a]
```

`scanl` accumulates the list from the left, and the second argument becomes the first item in the resulting list. So, `scanl (+) 0 [1,2,3] = [0,1,3,6]`.

```
scanl1 :: (a -> a -> a) -> [a] -> [a]
```

`scanl1` uses the first item of the list as a zero parameter. It is what you would typically use if the input and output items are the same type. Notice the difference in the type signatures between `scanl` and `scanl1`. `scanl1 (+) [1,2,3] = [1,3,6]`.

```
scanr :: (a -> b -> b) -> b -> [a] -> [b]
scanr (+) 0 [1,2,3] = [6,5,3,0]
```

```
scanr1 :: (a -> a -> a) -> [a] -> [a]
scanr1 (+) [1,2,3] = [6,5,3]
```

These two functions are the counterparts of `scanl` and `scanl1` that accumulate the totals from the right.

Exercises:

1. Write your own definition of `scanr`, first using recursion, and then using `foldr`. Do the same for `scanl` first using recursion then `foldl`.
2. Define the following functions:
 - `factList :: Integer -> [Integer]`, which returns a list of factorials from 1 up to its argument. For example, `factList 4 = [1,2,6,24]`. *More to be added*

14.3 filter

A common operation performed on lists is filtering² — generating a new list composed only of elements of the first list that meet a certain condition. A simple example: making a list of only even numbers from a list of integers.

```
retainEven :: [Int] -> [Int]
retainEven [] = []
retainEven (n:ns) =
  -- mod n 2 computes the remainder for the integer division of n by 2.
  if (mod n 2) == 0
    then n : (retainEven ns)
    else retainEven ns
```

This definition is somewhat verbose and specific. Prelude provides a concise and general `filter` function with type signature:

```
filter :: (a -> Bool) -> [a] -> [a]
```

So, a `(a -> Bool)` function tests an elements for some condition, we then feed in a list to be filtered, and we get back the filtered list.

To write `retainEven` using `filter`, we need to state the condition as an auxiliary `(a -> Bool)` function, like this one:

```
isEven :: Int -> Bool
isEven n = (mod n 2) == 0
```

And then `retainEven` becomes simply:

```
retainEven ns = filter isEven ns
```

We used `ns` instead of `xs` to indicate that we know these are numbers and not just anything, but we can ignore that and use a more terse point-free definition:

```
retainEven = filter isEven
```

² <https://en.wikipedia.org/wiki/Filter%20%28mathematics%29>

This is like what we demonstrated before for `map` and the folds. Like `filter`, those take another function as argument; and using them point-free emphasizes this "functions-of-functions" aspect.

14.4 List comprehensions

List comprehensions are syntactic sugar for some common list operations, such as filtering. For instance, instead of using the Prelude `filter`, we could write `retainEven` like this:

```
retainEven es = [n | n <- es, isEven n]
```

This compact syntax may look intimidating, but it is simple to break down. One interpretation is:

- (Starting from the middle) Take the list `es` and draw (the "`<-`") each of its elements as a value `n`.
- (After the comma) For each drawn `n` test the boolean condition `isEven n`.
- (Before the vertical bar) If (and only if) the boolean condition is satisfied, append `n` to the new list being created (note the square brackets around the whole expression).

Thus, if `es` is `[1,2,3,4]`, then we would get back the list `[2,4]`. 1 and 3 were not drawn because `(isEven n) == False`.

The power of list comprehensions comes from being easily extensible. Firstly, we can use as many tests as we wish (even zero!). Multiple conditions are written as a comma-separated list of expressions (which should evaluate to a Boolean, of course). For a simple example, suppose we want to modify `retainEven` so that only numbers larger than 100 are retained:

```
retainLargeEvens :: [Int] -> [Int]
retainLargeEvens es = [n | n <- es, isEven n, n > 100]
```

Furthermore, we are not limited to using `n` as the element to be appended when generating a new list. Instead, we could place any expression before the vertical bar (if it is compatible with the type of the list, of course). For instance, if we wanted to subtract one from every even number, all it would take is:

```
evensMinusOne es = [n - 1 | n <- es, isEven n]
```

In effect, that means the list comprehension syntax incorporates the functionalities of `map` and `filter`.

To further sweeten things, the left arrow notation in list comprehensions can be combined with pattern matching. For example, suppose we had a list of `(Int, Int)` tuples, and we would like to construct a list with the first element of every tuple whose second element is even. Using list comprehensions, we might write it as follows:

```
firstForEvenSeconds :: [(Int, Int)] -> [Int]
firstForEvenSeconds ps = [fst p | p <- ps, isEven (snd p)] -- here, p is for
pairs.
```

Patterns can make it much more readable:

```
firstForEvenSeconds ps = [x | (x, y) <- ps, isEven y]
```

As in other cases, arbitrary expressions may be used before the `|`. If we wanted a list with the double of those first elements:

```
doubleOfFirstForEvenSeconds :: [(Int, Int)] -> [Int]
doubleOfFirstForEvenSeconds ps = [2 * x | (x, y) <- ps, isEven y]
```

Not counting spaces, that function code is shorter than its descriptive name!

There are even more possible tricks:

```
allPairs :: [(Int, Int)]
allPairs = [(x, y) | x <- [1..4], y <- [5..8]]
```

This comprehension draws from *two* lists, and generates all possible (x, y) pairs with the first element drawn from `[1..4]` and the second from `[5..8]`. In the final list of pairs, the first elements will be those generated with the first element of the first list (here, 1), then those with the second element of the first list, and so on. In this example, the full list is (linebreaks added for clarity):

```
Prelude> [(x, y) | x <- [1..4], y <- [5..8]]
[(1,5),(1,6),(1,7),(1,8),
 (2,5),(2,6),(2,7),(2,8),
 (3,5),(3,6),(3,7),(3,8),
 (4,5),(4,6),(4,7),(4,8)]
```

We could easily add a condition to restrict the combinations that go into the final list:

```
somePairs = [(x, y) | x <- [1..4], y <- [5..8], x + y > 8]
```

This list only has the pairs with the sum of elements larger than 8; starting with $(1,8)$, then $(2,7)$ and so forth.

Exercises:

1. Write a `returnDivisible :: Int -> [Int] -> [Int]` function which filters a list of integers retaining only the numbers divisible by the integer passed as first argument. For integers `x` and `n`, `x` is divisible by `n` if `(mod x n) == 0` (note that the test for evenness is a specific case of that).
- 2.
3. Write a function `choosingTails :: [[Int]] -> [[Int]]` using list comprehension syntax with appropriate guards (filters) for empty lists returning a list of tails following a head bigger than 5:

```
choosingTails [[7,6,3], [], [6,4,2], [9,4,3], [5,5,5]]  
-- [[6,3], [4,2], [4,3]]
```
- 4.
5. Does the order of guards matter? You may find it out by playing with the function of the preceding exercise.
- 6.
7. Over this section we've seen how list comprehensions are essentially syntactic sugar for `filter` and `map`. Now work in the opposite direction and define alternative versions of the `filter` and `map` using the list comprehension syntax.
- 8.
9. Rewrite `doubleOfFirstForEvenSeconds` using `filter` and `map` instead of list comprehension.

15 Type declarations

You're not restricted to working with just the types provided by default with the language. There are many benefits to defining your own types:

- Code can be written in terms of the problem being solved, making programs easier to design, write and understand.
- Related pieces of data can be brought together in ways more convenient and meaningful than simply putting and getting values from lists or tuples.
- Pattern matching and the type system can be used to their fullest extent by making them work with your custom types.

Haskell has three basic ways to declare a new type:

- The `data` declaration, which defines new data types.
- The `type` declaration for type synonyms, that is, alternative names for existing types.
- The `newtype` declaration, which defines new data types equivalent to existing ones.

In this chapter, we will study `data` and `type`. In a later chapter, we will discuss `newtype` and see where it can be useful.

15.1 data and constructor functions

`data` is used to define new data types mostly using existing ones as building blocks. Here's a data structure for elements in a simple list of anniversaries:

```
data Anniversary = Birthday String Int Int Int      -- name, year, month, day
                 | Wedding String String Int Int Int -- spouse name 1, spouse
                 name 2, year, month, day
```

This declares a new data type `Anniversary`, which can be either a `Birthday` or a `Wedding`. A `Birthday` *contains* one string and three integers and a `Wedding` *contains* two strings and three integers. The definitions of the two possibilities are separated by the vertical bar. The comments explain to readers of the code about the intended use of these new types. Moreover, with the declaration we also get two *constructor functions* for `Anniversary`; appropriately enough, they are called `Birthday` and `Wedding`. These functions provide a way to build a new `Anniversary`.

Types defined by `data` declarations are often referred to as *algebraic data types*, which is something we will address further in later chapters.

As usual with Haskell, the case of the first letter is important: type names and constructor functions must start with capital letters. Other than this syntactic detail, constructor functions work pretty much like the "conventional" functions we have met so far. In fact, if you use `:t` in GHCi to query the type of, say, `Birthday`, you'll get:

```
• Main> :t Birthday Birthday :: String -> Int -> Int -> Int -> Anniversary
```

Meaning it's just a function which takes one `String` and three `Int` as arguments and *evaluates* to an `Anniversary`. This anniversary will contain the four arguments we passed as specified by the `Birthday` constructor.

Calling constructors is no different from calling other functions. For example, suppose we have John Smith born on 3rd July 1968:

```
johnSmith :: Anniversary
johnSmith = Birthday "John Smith" 1968 7 3
```

He married Jane Smith on 4th March 1987:

```
smithWedding :: Anniversary
smithWedding = Wedding "John Smith" "Jane Smith" 1987 3 4
```

These two anniversaries can, for instance, be put in a list:

```
anniversariesOfJohnSmith :: [Anniversary]
anniversariesOfJohnSmith = [johnSmith, smithWedding]
```

Or you could just as easily have called the constructors straight away when building the list (although the resulting code looks a bit cluttered).

```
anniversariesOfJohnSmith = [Birthday "John Smith" 1968 7 3, Wedding "John Smith"
"Jane Smith" 1987 3 4]
```

15.2 Deconstructing types

To use our new data types, we must have a way to access their contents. For instance, one very basic operation with the anniversaries defined above would be extracting the names and dates they contain as a `String`. So we need a `showAnniversary` function (for the sake of code clarity, we used an auxiliary `showDate` function but let's ignore it for a moment):

```
showDate :: Int -> Int -> Int -> String
showDate y m d = show y ++ "-" ++ show m ++ "-" ++ show d

showAnniversary :: Anniversary -> String

showAnniversary (Birthday name year month day) =
  name ++ " born " ++ showDate year month day

showAnniversary (Wedding name1 name2 year month day) =
  name1 ++ " married " ++ name2 ++ " on " ++ showDate year month day
```

This example shows how we can deconstruct the values built in our data types. `showAnniversary` takes a single argument of type `Anniversary`. Instead of just providing a name for the argument on the left side of the definition, however, we specify one of the constructor functions and give names to each argument of the constructor (which correspond to the contents of the `Anniversary`). A more formal way of describing this "giving names" process is to say we are *binding variables*. "Binding" is being used in the sense of

assigning a variable to each of the values so that we can refer to them on the right side of the function definition.

To handle both "Birthday" and "Wedding" Anniversaries, we needed to provide *two* function definitions, one for each constructor. When `showAnniversary` is called, if the argument is a `Birthday` Anniversary, the first definition is used and the variables `name`, `month`, `date` and `year` are bound to its contents. If the argument is a `Wedding` Anniversary, then the second definition is used and the variables are bound in the same way. This process of using a different version of the function depending on the type of constructor is pretty much like what happens when we use a `case` statement or define a function piece-wise.

Note that the parentheses around the constructor name and the bound variables are mandatory; otherwise the compiler or interpreter would not take them as a single argument. Also, it is important to have it absolutely clear that the expression inside the parentheses is *not* a call to the constructor function, even though it may look just like one.

Exercises:

Note: The solution of this exercise is given near the end of the chapter, so we recommend that you attempt it before getting there.

Reread the function definitions above. Then look closer at the `showDate` helper function. We said it was provided "for the sake of code clarity", but there is a certain clumsiness in the way it is used. You have to pass three separate `Int` arguments to it, but these arguments are always linked to each other as part of a single date. It would make no sense to do things like passing the year, month and day values of the `Anniversary` in a different order, or to pass the month value twice and omit the day.

- Could we use what we've seen in this chapter so far to reduce this clumsiness?
- Declare a `Date` type which is composed of three `Int`, corresponding to year, month and day. Then, rewrite `showDate` so that it uses the new `Date` data type. What changes will then be needed in `showAnniversary` and the `Anniversary` for them to make use of `Date`?

15.3 type for making type synonyms

As mentioned in the introduction of this module, code clarity is one of the motivations for using custom types. In that spirit, it could be nice to make it clear that the `Strings` in the `Anniversary` type are being used as *names* while still being able to manipulate them like ordinary `Strings`. This calls for a `type` declaration:

```
type Name = String
```

The code above says that a `Name` is now a synonym for a `String`. Any function that takes a `String` will now take a `Name` as well (and vice-versa: functions that take `Name` will accept any `String`). The right hand side of a `type` declaration can be a more complex type as well. For example, `String` itself is defined in the standard libraries as

```
type String = [Char]
```

We can do something similar for the list of anniversaries we made use of:

```
type AnniversaryBook = [Anniversary]
```

Type synonyms are mostly just a convenience. They help make the roles of types clearer or provide an alias to such things as complicated list or tuple types. It is largely a matter of personal discretion to decide how type synonyms should be deployed. Abuse of synonyms could make code confusing (for instance, picture a long program using multiple names for common types like `Int` or `String` simultaneously).

Incorporating the suggested type synonyms and the `Date` type we proposed in the exercise(*) of the previous section the code we've written so far looks like this:

((*) **last chance to try that exercise without looking at the spoilers.**)

```
type Name = String

data Anniversary =
  Birthday Name Date
  | Wedding Name Name Date

data Date = Date Int Int Int -- Year, Month, Day

johnSmith :: Anniversary
johnSmith = Birthday "John Smith" (Date 1968 7 3)

smithWedding :: Anniversary
smithWedding = Wedding "John Smith" "Jane Smith" (Date 1987 3 4)

type AnniversaryBook = [Anniversary]

anniversariesOfJohnSmith :: AnniversaryBook
anniversariesOfJohnSmith = [johnSmith, smithWedding]

showDate :: Date -> String
showDate (Date y m d) = show y ++ "-" ++ show m ++ "-" ++ show d

showAnniversary :: Anniversary -> String
showAnniversary (Birthday name date) =
  name ++ " born " ++ showDate date
showAnniversary (Wedding name1 name2 date) =
  name1 ++ " married " ++ name2 ++ " on " ++ showDate date
```

Even in a simple example like this one, there is a noticeable gain in simplicity and clarity compared to the same task using only `Ints`, `Strings`, and corresponding lists.

Note that the `Date` type has a constructor function which is called `Date` as well. That is perfectly valid and indeed giving the constructor the same name of the type when there is just one constructor is good practice, as a simple way of making the role of the function obvious.

Note:

After these initial examples, the mechanics of using constructor functions may look a bit unwieldy, particularly if you're familiar with analogous features in other languages. There are syntactical constructs that make dealing with constructors more convenient. These will be dealt with later on, when we return to the topic of constructors and data types to explore them in detail.

16 Pattern matching

In the previous modules, we introduced and made occasional reference to pattern matching. Now that we have developed some familiarity with the language, it is time to take a proper, deeper look. We will kick-start the discussion with a condensed description, which we will expand upon throughout the chapter:

*In pattern matching, we attempt to **match** values against **patterns** and, if so desired, **bind** variables to successful matches.*

16.1 Analysing pattern matching

Pattern matching is virtually everywhere. For example, consider this definition of `map`:

```
map _ [] = []
map f (x:xs) = f x : map f xs
```

At surface level, there are four different patterns involved, two per equation.

- `f` is a pattern which matches *anything at all*, and binds the `f` variable to whatever is matched.
- `(x:xs)` is a pattern that matches a *non-empty list* which is formed by something (which gets bound to the `x` variable) which was cons'd (by the `(:)` function) onto something else (which gets bound to `xs`).
- `[]` is a pattern that matches *the empty list*. It doesn't bind any variables.
- `_` is the pattern which matches anything without binding (wildcard, "don't care" pattern).

In the `(x:xs)` pattern, `x` and `xs` can be seen as sub-patterns used to match the parts of the list. Just like `f`, they match anything - though it is evident that if there is a successful match and `x` has type `a`, `xs` will have type `[a]`. Finally, these considerations imply that `xs` will also match an empty list, and so a one-element list matches `(x:xs)`.

From the above dissection, we can say pattern matching gives us a way to:

- *recognize values*. For instance, when `map` is called and the second argument matches `[]` the first equation for `map` is used instead of the second one.
- *bind variables* to the recognized values. In this case, the variables `f`, `x`, and `xs` are assigned to the values passed as arguments to `map` when the second equation is used, and so we can use these values through the variables in the right-hand side of `=`. As `_` and `[]` show, binding is not an essential part of pattern matching, but just a side effect of using variable names as patterns.
- *break down values into parts*, as the `(x:xs)` pattern does by binding two variables to parts (head and tail) of a matched argument (the non-empty list).

16.2 The connection with constructors

Despite the detailed analysis above, it may seem a little too magical how we break down a list as if we were undoing the effects of the `(:)` operator. Be careful: this process will not work with any arbitrary operator. For example, one might think of defining a function which uses `(++)` to chop off the first three elements of a list:

```
dropThree ([x,y,z] ++ xs) = xs
```

But that *will not work*. The function `(++)` is not allowed in patterns. In fact, most other functions that act on lists are similarly prohibited from pattern matching. Which functions, then, *are* allowed?

In one word, *constructors* – the functions used to build values of algebraic data types. Let us consider a random example:

```
data Foo = Bar | Baz Int
```

Here `Bar` and `Baz` are constructors for the type `Foo`. You *can* use them for pattern matching `Foo` values and bind variables to the `Int` value contained in a `Foo` constructed with `Baz`:

```
f :: Foo -> Int
f Bar      = 1
f (Baz x)  = x - 1
```

This is exactly like `showAnniversary` and `showDate` in the `Type declarations` module. For instance:

```
data Date = Date Int Int Int -- Year, Month, Day
showDate :: Date -> String
showDate (Date y m d) = show y ++ "-" ++ show m ++ "-" ++ show d
```

The `(Date y m d)` pattern in the left-hand side of the `showDate` definition matches a `Date` (built with the `Date` constructor) and binds the variables `y`, `m` and `d` to the contents of the `Date` value.

16.2.1 Why does it work with lists?

As for lists, they are no different from data-defined algebraic data types as far as pattern matching is concerned. It works as if lists were defined with this `data` declaration (note that the following isn't actually valid syntax: lists are actually too deeply ingrained into Haskell to be defined like this):

```
data [a] = [] | a : [a]
```

So the empty list, `[]` and the `(:)` function are constructors of the list datatype, and so you can pattern match with them. `[]` takes no arguments, and therefore no variables can be bound when it is used for pattern matching. `(:)` takes two arguments, the list head and tail, which may then have variables bound to them when the pattern is recognized.

```
Prelude> :t []
[] :: [a]
Prelude> :t (:)
```

```
(:) :: a -> [a] -> [a]
```

Furthermore, since `[x, y, z]` is just syntactic sugar for `x:y:z:[]`, we can achieve something like `dropThree` using pattern matching alone:

```
dropThree :: [a] -> [a]
dropThree (_:_:_:xs) = xs
dropThree _          = []
```

The first pattern will match any list with at least three elements. The catch-all second definition provides a reasonable default¹ when lists fail to match the main pattern, and thus prevents runtime crashes due to pattern match failure.

Note:

From the fact that we *could* write a `dropThree` function with bare pattern matching it doesn't follow that we *should* do so! Even though the solution is simple, it is still a waste of effort to code something this specific when we could just use Prelude and settle it with `drop 3 xs` instead. Mirroring what was said before about baking bare recursive functions, we might say: *don't get too excited about pattern matching either...*

16.2.2 Tuple constructors

Analogous considerations are valid for tuples. Our access to their components via pattern matching...

```
fstPlusSnd :: (Num a) => (a, a) -> a
fstPlusSnd (x, y) = x + y

norm3D :: (Floating a) => (a, a, a) -> a
norm3D (x, y, z) = sqrt (x^2 + y^2 + z^2)
```

... is granted by the existence of tuple constructors. For pairs, the constructor is the comma operator, `(,)`; for larger tuples there are `(,,)`, `(,,,)` and so on. These operators are slightly unusual in that we can't use them infix in the regular way; so `5 , 3` is not a valid way to write `(5, 3)`. All of them, however, can be used prefix, which is occasionally useful.

```
Prelude> (,) 5 3
(5,3)
Prelude> (,,) "George" "John" "Paul" "Ringo"
("George","John","Paul","Ringo")
```

16.3 Matching literal values

As discussed earlier in the book, a simple piece-wise function definition like this one

¹ Reasonable *for this particular task*, and only because it makes sense to expect that `dropThree` will give `[]` when applied to a list of, say, two elements. With a different problem, it might not be reasonable to return *any* list if the first match failed. In a later chapter, we will consider one simple way of dealing with such cases.

```
f :: Int -> Int
f 0 = 1
f 1 = 5
f 2 = 2
f _ = -1
```

is performing pattern matching as well, matching the argument of `f` with the `Int` literals 0, 1 and 2, and finally with `_`. In general, numeric and character literals can be used in pattern matching on their own² as well as together with constructor patterns. For instance, this function

```
g :: [Int] -> Bool
g (0:[]) = False
g (0:xs) = True
g _ = False
```

will evaluate to `False` for the `[0]` list, to `True` if the list has 0 as first element and a non-empty tail and to `False` in all other cases. Also, lists with literal elements like `[1,2,3]`, or even `"abc"` (which is equivalent to `['a','b','c']`) can be used for pattern matching as well, since these forms are only syntactic sugar for the `(:)` constructor.

The above considerations are only valid for literal values, so the following will **not** work:

```
k = 1
--again, this won't work as expected
h :: Int -> Bool
h k = True
h _ = False
```

Exercises:

1. Test the flawed `h` function above in GHCi, with arguments equal to and different from 1. Then, explain what goes wrong.
2. In this section about pattern matching with literal values, we made no mention of the boolean values `True` and `False`, but we can do pattern matching with them as well, as demonstrated in the Next steps^a chapter. Can you guess why we omitted them? (Hint: is there anything distinctive about the way we write boolean values?)

^a Chapter 9.2 on page 60

16.4 Syntax tricks

16.4.1 As-patterns

Sometimes, when matching a pattern with a value, it may be useful to bind a name to the whole value being matched. As-patterns allow exactly this: they are of the form `var@pattern` and have the additional effect to bind the name `var` to the whole value being matched by `pattern`. For instance, here is a toy variation on the map theme:

² As perhaps could be expected, this kind of matching with literals is not constructor-based. Rather, there is an equality comparison behind the scenes

```

contrivedMap :: ([a] -> a -> b) -> [a] -> [b]
contrivedMap f [] = []
contrivedMap f list@(x:xs) = f list x : contrivedMap f xs

```

`contrivedMap` passes to the parameter function `f` not only `x` but also the undivided list used as argument of each recursive call. Writing it without as-patterns would have been a bit clunky because we would have to either use `head` or needlessly *reconstruct* the original value of `list`, i.e. actually evaluate `x:xs` on the right side:

```

contrivedMap :: ([a] -> a -> b) -> [a] -> [b]
contrivedMap f [] = []
contrivedMap f (x:xs) = f (x:xs) x : contrivedMap f xs

```

Exercises:

Implement `scanr`, as in the exercise in Lists III^a, but this time using an as-pattern.

^a Chapter 14.2 on page 100

16.4.2 Introduction to records

For constructors with many elements, *records* provide a way of naming values in a datatype using the following syntax:

```

data Foo2 = Bar2 | Baz2 {bazNumber::Int, bazName::String}

```

Using records allows doing matching and binding only for the variables relevant to the function we're writing, making code much clearer:

```

h :: Foo2 -> Int
h Baz2 {bazName=name} = length name
h Bar2 {} = 0

x = Baz2 1 "Haskell"      -- construct by declaration order, try ":t Baz2" in
  GHCi
y = Baz2 {bazName = "Curry", bazNumber = 2} -- construct by name

h x -- 7
h y -- 5

```

Also, the `{}` pattern can be used for matching a constructor regardless of the datatype elements even if you don't use records in the `data` declaration:

```

data Foo = Bar | Baz Int
g :: Foo -> Bool
g Bar {} = True
g Baz {} = False

```

The function `g` does not have to be changed if we modify the number or the type of elements of the constructors `Bar` or `Baz`.

There are further advantages to using record syntax which we will cover in more details in the Named fields³ section of the More on datatypes chapter.

³ Chapter 24.2 on page 149

16.5 Where we can use pattern matching

The short answer is that *wherever you can bind variables, you can pattern match*. Let us have a glance at such places we have seen before; a few more will be introduced in the following chapters.

16.5.1 Equations

The most obvious use case is the left-hand side of function definition equations, which were the subject of our examples so far.

```
map _ [] = []
map f (x:xs) = f x : map f xs
```

In the `map` definition we're doing pattern matching on the left hand side of both equations, and also binding variables on the second one.

`let` expressions and `where` clauses

Both `let` and `where` are ways of doing local variable bindings. As such, you can also use pattern matching in them. A simple example:

```
y = let (x:_) = map (*2) [1,2,3]
     in x + 5
```

Or, equivalently,

```
y = x + 5
   where
     (x:_) = map (*2) [1,2,3]
```

Here, `x` will be bound to the first element of `map ((*2) [1,2,3]`. `y`, therefore, will evaluate to $2 + 5 = 7$.

16.5.2 Lambda abstractions

Pattern matching can be used directly in lambda abstractions:

```
swap = \ (x,y) -> (y,x)
```

It is clear, however, that this syntax permits only one pattern (or one for each argument in the case of a multi-argument lambda abstraction).

16.5.3 List comprehensions

After the `|` in list comprehensions you can pattern match. This is actually extremely useful, and adds a lot to the expressiveness of comprehensions. Let's see how that works with a slightly more sophisticated example. Prelude provides a `Maybe` type which has the following constructors:

```
data Maybe a = Nothing | Just a
```

It is typically used to hold values resulting from an operation which may or may not succeed; if the operation succeeds, the `Just` constructor is used and the value is passed to it; otherwise `Nothing` is used.⁴ The utility function `catMaybes` (which is available from `Data.Maybe` library module) takes a list of `Maybes` (which may contain both "Just" and "Nothing" `Maybes`), and retrieves the contained values by filtering out the `Nothing` values and getting rid of the `Just` wrappers of the `Just x`. Writing it with list comprehensions is very straightforward:

```
catMaybes :: [Maybe a] -> [a]
catMaybes ms = [ x | Just x <- ms ]
```

Another nice thing about using a list comprehension for this task is that if the pattern match fails (that is, it meets a `Nothing`) it just moves on to the next element in `ms`, thus avoiding the need of explicitly handling constructors we are not interested in with alternate function definitions.⁵

16.5.4 do blocks

Within a `do` block like the ones we used in the `Simple input and output`⁶ chapter, we can pattern match with the left-hand side of the left arrow variable bindings:

```
putFirstChar = do
  (c:_) <- getLine
  putStrLn [c]
```

Furthermore, the `let` bindings in `do` blocks are, as far as pattern matching is concerned, just the same as the "real" `let` expressions.

4 The canonical example of such an operation is looking up values in a *dictionary* - which might just be a `[(a, b)]` list with the tuples being key-value pairs, or a more sophisticated implementation. In any case, if we, given an arbitrary key, try to retrieve a value there is no guarantee we will actually find a value associated to the key.

5 The reason why it works this way instead of crashing out on a pattern matching failure has to do with the real nature of list comprehensions: They are actually wrappers for the list monad. We will eventually explain what that means when we discuss monads.

6 Chapter 10 on page 67

17 Control structures

Haskell offers several ways of expressing a choice between different values. We explored some of them in the Haskell Basics chapters. This section will bring together what we have seen thus far, discuss some finer points, and introduce a new control structure.

17.1 if and guards revisited

We have already met these constructs. The syntax for `if` expressions is:

```
if <condition> then <true-value> else <false-value>
```

`<condition>` is an expression which evaluates to a boolean. If the `<condition>` is `True` then the `<true-value>` is returned, otherwise the `<false-value>` is returned. Note that in Haskell `if` is an expression (which is converted to a value) and not a statement (which is executed) as in many imperative languages.¹ As a consequence, the `else` is *mandatory* in Haskell. Since `if` is an expression, it must evaluate to a result whether the condition is true or false, and the `else` ensures this. Furthermore, `<true-value>` and `<false-value>` must evaluate to the same type, which will be the type of the whole `if` expression.

When `if` expressions are split across multiple lines, they are usually indented by aligning `elses` with `thens`, rather than with `ifs`. A common style looks like this:

```
describeLetter :: Char -> String
describeLetter c =
    if c >= 'a' && c <= 'z'
        then "Lower case"
        else if c >= 'A' && c <= 'Z'
            then "Upper case"
            else "Not an ASCII letter"
```

Guards and top-level `if` expressions are mostly interchangeable. With guards, the example above is a little neater:

```
describeLetter :: Char -> String
describeLetter c
    | c >= 'a' && c <= 'z' = "Lower case"
    | c >= 'A' && c <= 'Z' = "Upper case"
    | otherwise           = "Not an ASCII letter"
```

Remember that `otherwise` is just an alias to `True`, and thus the last guard is a catch-all, playing the role of the final `else` of the `if` expression.

Guards are evaluated in the order they appear. Consider a set up like the following:

¹ If you have programmed in C or Java, you will recognize Haskell's `if/then/else` as an equivalent to the ternary conditional operator `?:`.

```
f (pattern1) | predicate1 = w
             | predicate2 = x

f (pattern2) | predicate3 = y
             | predicate4 = z
```

Here, the argument of `f` will be pattern-matched against `pattern1`. If it succeeds, then we proceed to the first set of guards: if `predicate1` evaluates to `True`, then `w` is returned. If not, then `predicate2` is evaluated; and if it is true `x` is returned. Again, if not, then we proceed to the next case and try to match the argument against `pattern2`, repeating the guards procedure with `predicate3` and `predicate4`. (Of course, if neither pattern matches or neither predicate is true for the matching pattern there will be a runtime error. Regardless of the chosen control structure, it is important to ensure all cases are covered.)

17.1.1 Embedding `if` expressions

A handy consequence of `if` constructs being *expressions* is that they can be placed anywhere a Haskell expression could be, allowing us to write code like this:

```
g x y = (if x == 0 then 1 else sin x / x) * y
```

Note that we wrote the `if` expression without line breaks for maximum terseness. Unlike `if` expressions, guard blocks are not expressions; and so a `let` or a `where` definition is the closest we can get to this style when using them. Needless to say, more complicated one-line `if` expressions would be hard to read, making `let` and `where` attractive options in such cases.

17.2 case expressions

One control structure we haven't talked about yet are `case` expressions. They are to piece-wise function definitions what `if` expressions are to guards. Take this simple piece-wise definition:

```
f 0 = 18
f 1 = 15
f 2 = 12
f x = 12 - x
```

It is equivalent to `-` and, indeed, syntactic sugar for:

```
f x =
  case x of
    0 -> 18
    1 -> 15
    2 -> 12
    _ -> 12 - x
```

Whatever definition we pick, the same happens when `f` is called: The argument `x` is matched against all of the patterns in order; and on the first match the expression on the right-hand side of the corresponding equal sign (in the piece-wise version) or arrow (in the `case` version)

is evaluated. Note that in this `case` expression there is no need to write `x` in the pattern; the wildcard pattern `_` gives the same effect.²

Indentation is important when using `case`. The cases must be indented further to the right than the beginning of the line containing the `of` keyword, and all cases must have the same indentation. For the sake of illustration, here are two other valid layouts for a `case` expression:

```
f x = case x of
  0 -> 18
  1 -> 15
  2 -> 12
  _ -> 12 - x

f x = case x of 0 -> 18
                1 -> 15
                2 -> 12
                _ -> 12 - x
```

Since the left hand side of any case branch is just a pattern, it can also be used for binding, exactly like in piece-wise function definitions:³

```
describeString :: String -> String
describeString str =
  case str of
    (x:xs) -> "The first character of the string is: " ++ [x] ++ "; and " ++
              "there are " ++ show (length xs) ++ " more characters in it."
    []      -> "This is an empty string."
```

This function describes some properties of `str` using a human-readable string. Using case syntax to bind variables to the head and tail of our list is convenient here, but you could also do this with an if-statement (with a condition of `null str` to pick the empty string case).

Finally, just like `if` expressions (and unlike piece-wise definitions), `case` expressions can be embedded anywhere another expression would fit:

```
data Colour = Black | White | RGB Int Int Int

describeBlackOrWhite :: Colour -> String
describeBlackOrWhite c =
  "This colour is"
  ++ case c of
      Black      -> " black"
      White      -> " white"
      RGB 0 0 0   -> " black"
      RGB 255 255 255 -> " white"
      _          -> "... uh... something else"
  ++ ", yeah?"
```

The case block above fits in as any string would. Writing `describeBlackOrWhite` this way makes `let/where` unnecessary (although the resulting definition is not as readable).

2 To see why this is so, consider our discussion of matching and binding in the [../Pattern matching/](#) [^]{Chapter16 on page 109} section

3 Thus, `case` statements are a lot more versatile than most of the superficially similar `switch/case` statements in imperative languages which are typically restricted to equality tests on integral primitive types.

Exercises:

Use a `case` statement to implement a `fakeIf` function which could be used as a replacement to the familiar `if` expressions.

17.3 Controlling actions, revisited

In the final part of this chapter, we will introduce a few extra points about control structures while revisiting the discussions in the "Simple input and output" chapter. There, in the Controlling actions⁴ section, we used the following function to show how to execute actions conditionally within a `do` block using `if` expressions:

```
doGuessing num = do
  putStrLn "Enter your guess:"
  guess <- getLine
  if (read guess) < num
    then do putStrLn "Too low!"
          doGuessing num
    else if (read guess) > num
          then do putStrLn "Too high!"
                doGuessing num
    else do putStrLn "You Win!"
```

We can write the same `doGuessing` function using a `case` statement. To do this, we first introduce the Prelude function `compare` which takes two values of the same type (in the `Ord` class) and returns a value of type `Ordering` — namely one of `GT`, `LT`, `EQ`, depending on whether the first is greater than, less than, or equal to the second.

```
doGuessing num = do
  putStrLn "Enter your guess:"
  guess <- getLine
  case compare (read guess) num of
    LT -> do putStrLn "Too low!"
          doGuessing num
    GT -> do putStrLn "Too high!"
          doGuessing num
    EQ -> do putStrLn "You Win!"
```

The `dos` after the `->`s are necessary on the first two options, because we are sequencing actions within each case.

17.3.1 A note about return

Now, we are going to dispel a possible source of confusion. In a typical imperative language (C, for example) an implementation of `doGuessing` might look like the following (if you don't know C, don't worry with the details, just follow the if-else chain):

```
void doGuessing(int num) {
  printf("Enter your guess:");
  int guess = atoi(readLine());
  if (guess == num) {
    printf("You win!\n");
    return;
  }
```

4 Chapter 10.2.2 on page 70

```

}

// we won't get here if guess == num
if (guess < num) {
    printf("Too low!\n");
    doGuessing(num);
} else {
    printf("Too high!\n");
    doGuessing(num);
}
}
}

```

This `doGuessing` first tests the equality case, which does not lead to a new call of `doGuessing`, and the `if` has no accompanying `else`. If the guess was right, a `return` statement is used to exit the function at once, skipping the other cases. Now, going back to Haskell, action sequencing in `do` blocks looks a lot like imperative code, and furthermore there actually *is* a `return` in Prelude. Then, knowing that `case` statements (unlike `if` statements) do not force us to cover all cases, one might be tempted to write a literal translation of the C code above (try running it if you are curious)...

```

doGuessing num = do
    putStrLn "Enter your guess:"
    guess <- getLine
    case compare (read guess) num of
        EQ -> do putStrLn "You win!"
              return ()

-- we don't expect to get here if guess == num
if (read guess < num)
    then do putStrLn "Too low!";
          doGuessing num
    else do putStrLn "Too high!";
          doGuessing num

```

... but it won't work! If you guess correctly, the function will first print "You win!" but it *will not exit* at the `return ()`. Instead, the program will continue to the `if` expression and check whether `guess` is less than `num`. Of course it is not, so the `else` branch is taken, and it will print "Too high!" and then ask you to guess again. Things aren't any better with an incorrect guess: it will try to evaluate the `case` statement and get either `LT` or `GT` as the result of the `compare`. In either case, it won't have a pattern that matches, and the program will fail immediately with an exception (as usual, the incomplete `case` alone should be enough to raise suspicion).

The problem here is that `return` is not at all equivalent to the C (or Java etc.) statement with the same name. For our immediate purposes, we can say that `return` is a *function*.⁵ The `return ()` in particular evaluates to an action which does nothing. `return` *does not affect the control flow at all*. In the correct guess case, the `case` statement evaluates to `return ()`, an action of type `IO ()`, and execution just follows along normally.

The bottom line is that while actions and `do` blocks resemble imperative code, they must be dealt with on their own terms - Haskell terms.

⁵ *Superfluous note:* somewhat closer to a proper explanation, we might say `return` is a function which takes a value and makes it into an action which, when evaluated, gives the original value. A `return "strawberry"` within one of the `do` blocks we are dealing with would have type `IO String` - the same type as `getLine`. Do not worry if that doesn't make sense for now; you will understand what `return` really does when we *actually* start discussing monads further ahead on the book.

Exercises:

1. Redo the "Haskell greeting" exercise in Simple input and output/Controlling actions^a, this time using a `case` statement.
2. What does the following program print out? And why?

```
main =
  do x <- getX
     putStrLn x

getX =
  do return "My Shangri-La"
     return "beneath"
     return "the summer moon"
     return "I will"
     return "return"
     return "again"
```

^a Chapter 10.2.2 on page 70

18 More on functions

Here are several nice features that make using functions easier.

18.1 let and where revisited

As discussed in earlier chapters, `let` and `where` are useful in local function definitions. Here, `sumStr` calls `addStr` function:

```
addStr :: Float -> String -> Float
addStr x str = x + read str
```

```
sumStr :: [String] -> Float
sumStr = foldl addStr 0.0
```

But what if we never need `addStr` anywhere else? Then we could rewrite `sumStr` using local bindings. We can do that either with a `let` binding...

```
sumStr =
  let addStr x str = x + read str
  in foldl addStr 0.0
```

... or with a `where` clause...

```
sumStr = foldl addStr 0.0
  where addStr x str = x + read str
```

... and the difference appears to be just a question of style: Do we prefer the bindings to come before or after the rest of the definition?

However, there is another important difference between `let` and `where`. The `let...in` construct is an expression just like `if/then/else`. In contrast, `where` clauses are like guards and so are not expressions. Thus, `let` bindings can be used within complex expressions:

```
f x =
  if x > 0
  then (let lsq = (log x) ^ 2 in tan lsq) * sin x
  else 0
```

The expression within the outer parentheses is self-contained, and evaluates to the tangent of the square of the logarithm of `x`. Note that the scope of `lsq` does not extend beyond the parentheses; so changing the `then`-branch to

```
then (let lsq = (log x) ^ 2 in tan lsq) * (sin x + lsq)
```

does not work without dropping the parentheses around the `let`.

Despite not being full expressions, `where` clauses *can* be incorporated into `case` expressions:

```
describeColour c =
  "This colour "
  ++ case c of
    Black -> "is black"
    White -> "is white"
    RGB red green blue -> " has an average of the components of " ++ show
  av
    where av = (red + green + blue) `div` 3
  ++ ", yeah?"
```

In this example, the indentation of the `where` clause sets the scope of the `av` variable so that it only exists as far as the `RGB red green blue` case is concerned. Placing it at the same indentation of the cases would make it available for all cases. Here is an example with guards:

```
doStuff :: Int -> String
doStuff x
  | x < 3    = report "less than three"
  | otherwise = report "normal"
  where
    report y = "the input is " ++ y
```

Note that since there is one equals sign for each guard there is no place we could put a `let` expression which would be in scope of all guards in the manner of the `where` clause. So this is a situation in which `where` is particularly convenient.

18.2 Anonymous Functions - lambdas

Why create a formal name for a function like `addStr` when it only exists within another function's definition, never to be used again? Instead, we can make it an anonymous function also known as a "lambda function". Then, `sumStr` could be defined like this:

```
sumStr = foldl (\ x str -> x + read str) 0.0
```

The expression in the parentheses is a lambda function. The backslash is used as the nearest ASCII equivalent to the Greek letter lambda (λ). This lambda function takes two arguments, `x` and `str`, and it evaluates to `"x + read str"`. So, the `sumStr` presented just above is precisely the same as the one that used `addStr` in a `let` binding.

Lambdas are handy for writing one-off functions to be used with `maps`, `folds` and their siblings, especially where the function in question is simple (beware of cramming complicated expressions in a lambda — it can hurt readability).

Since variables are being bound in a lambda expression (to the arguments, just like in a regular function definition), pattern matching can be used in them as well. A trivial example would be redefining `tail` with a lambda:

```
tail' = (\ (_:xs) -> xs)
```

Note: Since lambdas are a special character in Haskell, the `\` on its own will be treated as the function and whatever non-space character is next will be the variable for the first argument. It is still good form to put a space between the lambda and the argument as in

normal function syntax (especially to make things clearer when a lambda takes more than one argument).

18.3 Operators

In Haskell, any function that takes two arguments and has a name consisting entirely of non-alphanumeric characters is considered an *operator*. The most common examples are the arithmetical ones like addition (+) and subtraction (-). Unlike other functions, operators are normally used infix (written between the two arguments). All operators can also be surrounded with parentheses and then used prefix like other functions:

```
-- these are the same:
2 + 4
(+ ) 2 4
```

We can define new operators in the usual way as other functions — just don't use any alphanumeric characters in their names. For example, here's the set-difference definition from `Data.List`:

```
(\\) :: (Eq a) => [a] -> [a] -> [a]
xs \\ ys = foldl (\zs y -> delete y zs) xs ys
```

As the example above shows, operators can be defined infix as well. The same definition written as prefix also works:

```
(\\) xs ys = foldl (\zs y -> delete y zs) xs ys
```

Note that the type declarations for operators have no infix version and must be written with the parentheses.

18.3.1 Sections

Sections are a nifty piece of syntactical sugar that can be used with operators. An operator within parentheses and flanked by one of its arguments...

```
(2+) 4
(+4) 2
```

... is a new function in its own right. (2+), for instance, has the type `(Num a) => a -> a`. We can pass sections to other functions, e.g. `map (+2) [1..4] == [3..6]`. For another example, we can add an extra flourish to the `multiplyList` function we wrote back in [More about lists](#):

```
multiplyList :: Integer -> [Integer] -> [Integer]
multiplyList m = map (m*)
```

If you have a "normal" prefix function and want to use it as an operator, simply surround it with backticks:

```
1 `elem` [1..4]
```

This is called making the function *infix*. It's normally done for readability purposes: `1 `elem` [1..4]` reads better than `elem 1 [1..4]`. You can also define functions infix:

```
elem :: (Eq a) => a -> [a] -> Bool
x `elem` xs = any (==x) xs
```

But once again notice that the type signature stays with the prefix style.

Sections even work with infix functions:

```
(1 `elem`) [1..4]
(`elem` [1..4]) 1
```

Of course, remember that you can only make binary functions (that is, those that take two arguments) infix.

Exercises:

- Lambdas are a nice way to avoid defining unnecessary separate functions. Convert the following let- or where-bindings to lambdas:
 - `map f xs` where `f x = x * 2 + 3`
 - `let f x y = read x + y in foldr f 1 xs`
- Sections are just syntactic sugar for lambda operations. I.e. `(+2)` is equivalent to `\x -> x + 2`. What would the following sections 'desugar' to? What would be their types?
 - `(4+)`
 - `(1 `elem`)`
 - `(`notElem` "abc")`

19 Higher-order functions

At the heart of functional programming is the idea that functions are *just like any other value*. The power of functional style comes from handling functions themselves as regular values, i.e. by passing functions to other functions and returning them from functions. A function that takes another function (or several functions) as an argument is called a *higher-order function*. They can be found pretty much anywhere in a Haskell program; and indeed we have already met some of them, such as `map` and the various folds. We saw commonplace examples of higher-order functions when discussing `map` in Lists II¹. Now, we are going to explore some common ways of writing code that manipulates functions.

19.1 A sorting algorithm

For a concrete example, we will consider the task of sorting a list. *Quicksort* is a well-known recursive sorting algorithm. To apply its sorting strategy to a list, we first choose one element and then divide the rest of the list into (A) those elements that should go before the chosen element, (B) those elements equal to the chosen one, and (C) those that should go after. Then, we apply the same algorithm to the unsorted (A) and (C) lists. After enough recursive sorting, we concatenate everything back together and have a final sorted list. That strategy can be translated into a Haskell implementation in a very simple way.

```
-- Type signature: any list with elements in the Ord class can be sorted.
quickSort :: (Ord a) => [a] -> [a]
-- Base case:
-- If the list is empty, there is nothing to do.
quickSort [] = []

-- The recursive case:
-- We pick the first element as our "pivot", the rest is to be sorted.
-- Note how the pivot itself ends up included in the middle part.
quickSort (x : xs) = (quickSort less) ++ (x : equal) ++ (quickSort more)
  where
    less = filter (< x) xs
    equal = filter (== x) xs
    more = filter (> x) xs
```

It should be pointed out that our `quickSort` is rather naïve. A more efficient implementation would avoid the three passes through `filter` at each recursive step and not use `(++)` to build the sorted list. Furthermore, unlike our implementation, the *original* quicksort algorithm does the sorting in-place using mutability.² We will ignore such concerns for now, as we are more interested in the usage patterns of sorting functions, rather than in exact implementation.

1 Chapter 13 on page 87

2 The "true", in-place quicksort *can* be done in Haskell, but it requires some rather advanced tools that we will not discuss in the Beginners' Track.

19.1.1 The Ord class

Almost all the basic data types in Haskell are members of the `Ord` class, which is for ordering tests what `Eq` is for equality tests. The `Ord` class defines which ordering is the "natural" one for a given type. It provides a function called `compare`, with type:

```
compare :: (Ord a) => a -> a -> Ordering
```

`compare` takes two values and compares them, returning an `Ordering` value, which is `LT` if the first value is *less than* the second, `EQ` if it is *equal* and `GT` if it is *greater than*. For an `Ord` type, `(<)`, `(==)` from `Eq` and `(>)` can be seen as shortcuts to `compare` that check for one of the three possibilities and return a `Bool` to indicate whether the specified ordering is true according to the `Ord` specification for that type. Note that each of the tests we use with `filter` in the definition of `quickSort` corresponds to one of the possible results of `compare`, and so we might have written, for instance, `less` as `less = filter (\y -> y `compare` x == LT) xs`.

19.2 Choosing how to compare

With `quickSort`, sorting any list with elements in the `Ord` class is easy. Suppose we have a list of `String` and we want to sort them; we just apply `quickSort` to the list. For the rest of this chapter, we will use a pseudo-dictionary of just a few words (but dictionaries with thousands of words would work just as well):

```
dictionary = ["I", "have", "a", "thing", "for", "Linux"]
```

`quickSort dictionary` returns:

```
["I", "Linux", "a", "for", "have", "thing"]
```

As you can see, capitalization is considered for sorting by default. Haskell `Strings` are lists of Unicode characters. Unicode (and almost all other encodings of characters) specifies that the character code for capital letters are less than the lower case letters. So "Z" is less than "a".

To get a proper dictionary-like sorting, we need a case insensitive `quickSort`. To achieve that, we can take a hint from the discussion of `compare` just above. The recursive case of `quickSort` can be rewritten as:

```
quickSort compare (x : xs) = (quickSort compare less) ++ (x : equal) ++
  (quickSort compare more)
  where
    less = filter (\y -> y `compare` x == LT) xs
    equal = filter (\y -> y `compare` x == EQ) xs
    more = filter (\y -> y `compare` x == GT) xs
```

While this version is less tidy than the original one, it makes it obvious that the ordering of the elements hinges entirely on the `compare` function. That means we only need to replace `compare` with an `(Ord a) => a -> a -> Ordering` function of our choice. Therefore, our updated `quickSort'` is a higher-order function which takes a comparison function along with the list to sort.

```

quickSort' :: (Ord a) => (a -> a -> Ordering) -> [a] -> [a]
-- No matter how we compare two things the base case doesn't change,
-- so we use the _ "wildcard" to ignore the comparison function.
quickSort' _ [] = []

-- c is our comparison function
quickSort' c (x : xs) = (quickSort' c less) ++ (x : equal) ++ (quickSort' c
more)
  where
    less = filter (\y -> y `c` x == LT) xs
    equal = filter (\y -> y `c` x == EQ) xs
    more = filter (\y -> y `c` x == GT) xs

```

We can reuse our `quickSort'` function to serve many different purposes.

If we wanted a *descending* order, we could just reverse our original sorted list with `reverse` (`quickSort` dictionary). Yet to actually do the initial sort descending, we could supply `quickSort'` with a comparison function that returns the opposite of the usual `Ordering`.

```

-- the usual ordering uses the compare function from the Ord class
usual = compare

-- the descending ordering, note we flip the order of the arguments to compare
descending x y = compare y x

-- the case-insensitive version is left as an exercise!
insensitive = ...
-- How can we do case-insensitive comparisons without making a big list of all
possible cases?

```

Note:

`Data.List` offers a `sort` function for sorting lists. It does not use quicksort; rather, it uses an efficient implementation of an algorithm called *mergesort*. `Data.List` also includes `sortBy`, which takes a custom comparison function just like our `quickSort'`

Exercises:

Write `insensitive`, such that `quickSort' insensitive dictionary` gives `["a", "for", "have", "I", "Linux", "thing"]`.

19.3 Higher-Order Functions and Types

The concept of *currying* (the generating of intermediate functions on the way toward a final result) was first introduced in the earlier chapter "More about lists". This is a good place to revisit how currying works.

Our `quickSort'` has type `(a -> a -> Ordering) -> [a] -> [a]`.

Most of the time, the type of a higher-order function provides a guideline about how to use it. A straightforward way of reading the type signature would be "quickSort' takes, as its first argument, a function that gives an ordering of two as. Its second argument is a list of as. Finally, it returns a new list of as". This is enough to correctly guess that it uses the given ordering function to sort the list.

Note that the parentheses surrounding `a -> a -> Ordering` are mandatory. They specify that `a -> a -> Ordering` forms a single argument that happens to be a function.

Without the parentheses, we would get `a -> a -> Ordering -> [a] -> [a]` which accepts four arguments (none of which are themselves functions) instead of the desired two, and that wouldn't work as desired.

Remember that the `->` operator is right-associative. Thus, our erroneous type signature `a -> a -> Ordering -> [a] -> [a]` means the same thing as `a -> (a -> (Ordering -> ([a] -> [a])))`.

Given that `->` is right-associative, the explicitly grouped version of the correct `quickSort'` signature is actually `(a -> a -> Ordering) -> ([a] -> [a])`. This makes perfect sense. Our original `quickSort` lacking the adjustable comparison function argument was of type `[a] -> [a]`. It took a list and sorted it. Our new `quickSort'` is simply a function that generates `quickSort` style functions! If we plug in `compare` for the `(a -> a -> Ordering)` part, then we just return our original simple `quickSort` function. If we use a different comparison function for the argument, we generate a *different* variety of a `quickSort` function.

Of course, if we not only give a comparison function as an argument but also feed in an actual list to sort, then the final result is not the new `quickSort`-style function; instead, it continues on and passes the list to the new function and returns the sorted list as our final result.

Exercises:

(*Challenging*) The following exercise combines what you have learned about higher order functions, recursion and I/O. We are going to recreate what is known in imperative languages as a *for loop*. Implement a function

```
for :: a -> (a -> Bool) -> (a -> a) -> (a -> IO ()) -> IO ()
for i p f job = -- ???
```

An example of how this function would be used might be

```
for 1 (<10) (+1) print
```

which prints the numbers 1 to 9 on the screen.

The desired behaviour of `for` is: starting from an initial value `i`, `for` executes `job i`. It then uses `f` to modify this value and checks to see if the modified value `f i` satisfies some condition `p`. If it doesn't, it stops; otherwise, the for loop continues, using the modified `f i` in place of `i`.

1. Implement the for loop in Haskell.
2. The paragraph just above gives an imperative description of the for loop. Describe your implementation in more functional terms.
Some more challenging exercises you could try
3. Consider a task like "print the list of numbers from 1 to 10". Given that `print` is a function, and we can apply it to a list of numbers, using `map` sounds like the natural thing to do. But would it actually work?
4. Implement a function `sequenceIO :: [IO a] -> IO [a]`. Given a list of actions, this function runs each of the actions in order and returns all their results as a list.
5. Implement a function `mapIO :: (a -> IO b) -> [a] -> IO [b]` which given a function of type `a -> IO b` and a list of type `[a]`, runs that action on each item in the list, and returns the results.

This exercise was inspired from a blog post by `osfameron`. No peeking!

19.4 Function manipulation

We will close the chapter by discussing a few examples of common and useful general-purpose higher-order functions. Familiarity with these will greatly enhance your skill at both writing and reading Haskell code.

19.4.1 Flipping arguments

`flip` is a handy little Prelude function. It takes a function of two arguments and returns a version of the same function with the arguments swapped.

```
flip :: (a -> b -> c) -> b -> a -> c
```

`flip` in use:

```
Prelude> (flip (/)) 3 1
0.3333333333333333
Prelude> (flip map) [1,2,3] (*2)
[2,4,6]
```

We could have used `flip` to write a point-free version of the `descending` comparing function from the `quickSort` example:

```
descending = flip compare
```

`flip` is particularly useful when we want to pass a function with two arguments of different types to another function and the arguments are in the wrong order with respect to the signature of the higher-order function.

19.4.2 Composition

The `(.)` composition operator is another higher-order function. It has the signature:

```
(.) :: (b -> c) -> (a -> b) -> a -> c
```

`(.)` takes two functions as arguments and returns a new function which applies both the second argument and then the first.

Composition and higher-order functions provide a range of powerful tricks. For a tiny sample, first consider the `inits` function, defined in the module `Data.List`. Quoting the documentation, it "returns all initial segments of the argument, shortest first", so that:

```
Prelude Data.List> inits [1,2,3]
[[], [1], [1,2], [1,2,3]]
```

We can provide a one-line implementation for `inits` (written point-free for extra dramatic effect) using only the following higher-order functions from Prelude: `flip`, `scanl`, `(.)` and `map`:

```
myInits :: [a] -> [[a]]
myInits = map reverse . scanl (flip (:)) []
```

Swallowing a definition so condensed may look daunting at first, so analyze it slowly, bit by bit, recalling what each function does and using the type signatures as a guide.

The definition of `myInits` is super concise and clean with use of parentheses kept to a bare minimum. Naturally, if one goes overboard with composition by writing mile-long `(.)` chains, things will get confusing; but, when deployed reasonably, these point-free styles shine. Furthermore, the implementation is quite "high level": we do not deal explicitly with details like pattern matching or recursion; the functions we deployed — both the higher-order ones and their functional arguments — take care of such plumbing.

19.4.3 Application

`($)` is a curious higher-order operator. Its type is:

```
($) :: (a -> b) -> a -> b
```

It takes a function as its first argument, and *all* it does is to apply the function to the second argument, so that, for instance, `(head $ "abc") == (head "abc")`.

You might think that (\$) is completely useless! However, there are two interesting points about it. First, (\$) has very low precedence,³ unlike regular function application which has the highest precedence. In effect, that means we can avoid confusing nesting of parentheses by breaking precedence with \$. We write a non-point-free version of myInits without adding new parentheses:

```
myInits :: [a] -> [[a]]
myInits xs = map reverse . scanl (flip (:)) [] $ xs
```

Furthermore, as (\$) is just a function which happens to apply functions, and functions are just values, we can write intriguing expressions such as:

```
map ($ 2) [(2*), (4*), (8*)]
```

(Yes, that is a list of functions, and it is perfectly legal.)

19.4.4 uncurry and curry

As the name suggests, uncurry is a function that undoes currying; that is, it converts a function of two arguments into a function that takes a pair as its only argument.

```
uncurry :: (a -> b -> c) -> (a, b) -> c
```

```
Prelude> let addPair = uncurry (+)
Prelude> addPair (2, 3)
5
```

One interesting use of uncurry occasionally seen in the wild is in combination with (\$), so that the first element of a pair is applied to the second.

```
Prelude> uncurry ($) (reverse, "stressed")
"desserts"
```

There is also curry, which is the opposite of uncurry.

```
curry :: ((a, b) -> c) -> a -> b -> c
```

```
Prelude> curry addPair 2 3 -- addPair as in the earlier example.
5
```

Because most Haskell functions are already curried, curry is nowhere near as common as uncurry.

³ As a reminder, precedence here is meant in the same sense that * has higher precedence (i.e. is evaluated first) than + in mathematics.

19.4.5 id and const

Finally, we should mention two functions which, while not higher-order functions themselves, are most often used as arguments to higher-order functions. `id`, the *identity* function, is a function with type `a -> a` that returns its argument unchanged.

```
Prelude> id "Hello"
"Hello"
```

Similar in spirit to `id`, `const` is an `a -> b -> a` function that works like this:

```
Prelude> const "Hello" "world"
"Hello"
```

`const` takes two arguments, discards the second and returns the first. Seen as a function of one argument, `a -> (b -> a)`, it returns a constant function, which always returns the same value no matter what argument it is given.

`id` and `const` might appear worthless at first. However, when dealing with higher-order functions it is sometimes necessary to pass a dummy function, be it one that does nothing with its argument or one that always returns the same value. `id` and `const` give us convenient dummy functions for such cases.

Exercises:

1. Write implementations for `curry`, `uncurry` and `const`.
2. Describe what the following functions do without testing them:
 - `uncurry const`
 - `curry fst`
 - `curry swap`, where `swap :: (a, b) -> (b, a)` swaps the elements of a pair. (`swap` can be found in `Data.Tuple`.)
3. (*Very hard*) Use `foldr` to implement `foldl`. Hint: begin by reviewing the sections about `foldr` and `foldl` in Lists III^a. There are two solutions; one is easier but relatively boring and the other is truly interesting. For the interesting one, think carefully about how you would go about composing all functions in a list.

^a Chapter 14.1.1 on page 96

20 Using GHCi effectively

GHCi assists in several ways toward more efficient work. Here, we will discuss some of the best practices for using GHCi.

20.1 User interface

20.1.1 Tab completion

As in many other terminal programs, you can enter some starting text in GHCi and then hit the Tab key to be presented with a list of all possibilities that start with what you've written so far. When there is only one possibility, using Tab will auto-complete the string. For example `fol<Tab>` will append letter "d" (since nothing exists with "fol" other than items that start with "fold"). A second Tab will list the four functions included in Prelude: `foldl`, `foldl1`, `foldr`, and `foldr1`. More options may show if you have already imported additional modules.

Tab completion works also when you are loading a file with your program into GHCi. For example, after typing `:l fi<Tab>`, you will be presented with all files that start with "fi" that are present in the current directory (the one you were in when you launched GHCi).

The same also applies when you are importing modules, after typing `:m +Da<Tab>` or `import Da<Tab>`, you will be presented with all modules that start with "Da" present in installed packages.

20.1.2 ":" commands

On GHCi command line, commands for the interpreter start with the character ":" (colon).

- `:help` or `:h` -- prints a list of all available commands.
- `:load` or `:l` -- loads a given file into GHCi (you must include the filename with the command).
- `:reload` or `:r` -- reloads whatever file had been loaded most recently (useful after changes to the file).
- `:type` or `:t` -- prints the type of a given expression included with the command
- `:module` or `:m` -- loads a given module (include the module name with the command). You can also *unload* a module by adding a - symbol before the module name.
- `:browse` -- gives the type signatures for all functions available from a given module.

Here again, you can use Tab to see the list of commands, type `:Tab` to see all possible commands.

20.1.3 Timing Functions in GHCi

GHCi provides a basic way to measure how much time a function takes to run, which can be useful for to find out which version of a function runs fastest (such as when there are multiple ways to define something to get the same effective result).

1. Type `:set +s` into the ghci command line.
2. run the function(s) you are testing. The time the function took to run will be displayed after GHCi outputs the results of the function.

20.1.4 Multi-line Input

If you are trying to define a function that takes up multiple lines, or if you want to type a do block into ghci (without writing a file that you then import), there is an easy way to do this:

1. Begin a new line with `{`
2. Type in your code. Press enter when you need a new line.
3. Type `}` to end the multi-line input.

For example:

```
*Main> {:  
*Main| let askname = do  
*Main|     putStrLn "What is your name?"  
*Main|     name <- getLine  
*Main|     putStrLn $ "Hello " ++ name  
*Main| :}  
*Main>
```

The same can be accomplished by using `:set +m` command (allow multi-line commands). In this case, an empty line will end the block.

In addition, line breaks in ghci commands can be separated by `;`, like this:

```
*Main> let askname1 = do ; putStrLn "what is your name?" ; name <- getLine ;  
putStrLn $ "Hello " ++ name
```

21 Intermediate Haskell

22 Modules

Modules are the primary means of organizing Haskell code. We met them in passing when using `import` statements to put library functions into scope. Beyond allowing us to make better use of libraries, knowledge of modules will help us to shape our own programs and create standalone programs which can be executed independently of GHCi (incidentally, that is the topic of the very next chapter, `./Standalone programs`¹).

22.1 Modules

Haskell modules² are a useful way to group a set of related functionalities into a single package and manage different functions that may have the same names. The module definition is the first thing that goes in your Haskell file.

A basic module definition looks like:

```
module YourModule where
```

Note that

1. the name of the module begins with a capital letter;
2. each file contains only one module.

The name of the file is the name of the module plus the `.hs` file extension. Any dots `'.'` in the module name are changed for directories.³ So the module `YourModule` would be in the file `YourModule.hs` while a module `Foo.Bar` would be in the file `Foo/Bar.hs` or `Foo\Bar.hs`. Since the module name must begin with a capital letter, the file name must also start with a capital letter.

22.2 Importing

Modules can themselves import functions from other modules. That is, in between the module declaration and the rest of your code, you may include some import declarations such as

```
import Data.Char (toLower, toUpper) -- import only the functions toLower and
```

1 Chapter 78 on page 557

2 See the Haskell report for more details on the module system [^]<http://www.haskell.org/onlinereport/modules.html> .

3 In Haskell98, the last standardised version of Haskell before Haskell 2010, the module system was fairly conservative, but recent common practice consists of employing a hierarchical module system, using periods to section off namespaces.

```

toUpper from Data.Char

import Data.List -- import everything exported from Data.List

import MyModule -- import everything exported from MyModule

```

Imported datatypes are specified by their name, followed by a list of imported constructors in parenthesis. For example:

```

import Data.Tree (Tree(Node)) -- import only the Tree data type and its Node
    constructor from Data.Tree

```

What if you import some modules that have overlapping definitions? Or if you import a module but want to overwrite a function yourself? There are three ways to handle these cases: Qualified imports, hiding definitions, and renaming imports.

22.2.1 Qualified imports

Say `MyModule` and `MyOtherModule` both have a definition for `remove_e`, which removes all instances of `e` from a string. However, `MyModule` only removes lower-case `e`'s, and `MyOtherModule` removes both upper and lower case. In this case the following code is ambiguous:

```

import MyModule
import MyOtherModule

-- someFunction puts a c in front of the text, and removes all e's from the rest
someFunction :: String -> String
someFunction text = 'c' : remove_e text

```

It isn't clear which `remove_e` is meant! To avoid this, use the **qualified** keyword:

```

import qualified MyModule
import qualified MyOtherModule

someFunction text = 'c' : MyModule.remove_e text -- Will work, removes lower
    case e's
someOtherFunction text = 'c' : MyOtherModule.remove_e text -- Will work, removes
    all e's
someIllegalFunction text = 'c' : remove_e text -- Won't work as there is no
    remove_e defined

```

In the latter code snippet, no function named `remove_e` is available at all. When we do qualified imports, all the imported values include the module names as a prefix. Incidentally, you can also use the same prefixes even if you did a regular import (in our example, `MyModule.remove_e` works even if the "qualified" keyword isn't included).

Note:

There is an ambiguity between a qualified name like `MyModule.remove_e` and the function composition operator (`.`). Writing `reverse.MyModule.remove_e` is bound to confuse your Haskell compiler. One solution is stylistic: always use spaces for function composition, for example, `reverse . remove_e` or `Just . remove_e` or even `Just . MyModule.remove_e`

22.2.2 Hiding definitions

Now suppose we want to import both `MyModule` and `MyOtherModule`, but we know for sure we want to remove all `e`'s, not just the lower cased ones. It will become really tedious to add `MyOtherModule` before every call to `remove_e`. Can't we just exclude the `remove_e` from `MyModule`?

```
import MyModule hiding (remove_e)
import MyOtherModule

someFunction text = 'c' : remove_e text
```

This works because of the word **hiding** on the import line. Whatever follows the "hiding" keyword will not be imported. Hide multiple items by listing them with parentheses and comma-separation:

```
import MyModule hiding (remove_e, remove_f)
```

Note that algebraic datatypes and type synonyms cannot be hidden. These are always imported. If you have a datatype defined in multiple imported modules, you must use qualified names.

22.2.3 Renaming imports

This is not really a technique to allow for overwriting, but it is often used along with the qualified flag. Imagine:

```
import qualified MyModuleWithAVeryLongModuleName

someFunction text = 'c' : MyModuleWithAVeryLongModuleName.remove_e text
```

Especially when using qualified, this gets irritating. We can improve things by using the **as** keyword:

```
import qualified MyModuleWithAVeryLongModuleName as Shorty

someFunction text = 'c' : Shorty.remove_e text
```

This allows us to use `Shorty` instead of `MyModuleWithAVeryLongModuleName` as prefix for the imported functions. This renaming works with both qualified and regular importing.

As long as there are no conflicting items, we can import multiple modules and rename them the same:

```
import MyModule as My
import MyCompletelyDifferentModule as My
```

In this case, both the functions in `MyModule` and the functions in `MyCompletelyDifferentModule` can be prefixed with `My`.

22.2.4 Combining renaming with limited import

Sometimes it is convenient to use the import directive twice for the same module. A typical scenario is as follows:

```
import qualified Data.Set as Set
import Data.Set (Set, empty, insert)
```

This gives access to all of the `Data.Set` module via the alias `Set`, and also lets you access a few selected functions (`empty`, `insert`, and the constructor) without using the `Set` prefix.

22.3 Exporting

In the examples at the start of this article, the words `import everything exported from MyModule` were used.⁴ This raises a question. How can we decide which functions are exported and which stay `internal`? Here's how:

```
module MyModule (remove_e, add_two) where

add_one blah = blah + 1

remove_e text = filter (/= 'e') text

add_two blah = add_one . add_one $ blah
```

In this case, only `remove_e` and `add_two` are exported. While `add_two` is allowed to make use of `add_one`, functions in modules that import `MyModule` cannot use `add_one` directly, as it isn't exported.

Datatype export specifications are written similarly to import. You name the type, and follow with the list of constructors in parenthesis:

```
module MyModule2 (Tree(Branch, Leaf)) where

data Tree a = Branch {left, right :: Tree a}
              | Leaf a
```

In this case, the module declaration could be rewritten `MyModule2 (Tree(..))`, declaring that all constructors are exported.

Maintaining an export list is good practice not only because it reduces namespace pollution but also because it enables certain compile-time optimizations⁵ which are unavailable otherwise.

4 A module may export functions that it imports. Mutually recursive modules are possible but need some special treatment [^]{http://www.haskell.org/ghc/docs/latest/html/users_guide/separate-compilation.html#mutual-recursion} .

5 <http://www.haskell.org/haskellwiki/Performance/GHC#Inlining>

23 Indentation

Haskell relies on indentation to reduce the verbosity of your code. Despite some complexity in practice, there are really only a couple fundamental layout rules.¹

23.1 The golden rule of indentation

Code which is part of some expression should be indented further in than the beginning of that expression (even if the expression is not the leftmost element of the line).

The easiest example is a 'let' binding group. The equations binding the variables are part of the 'let' expression, and so should be indented further in than the beginning of the binding group: the 'let' keyword. When you start the expression on a separate line, you only need to indent by one space (although more than one space is also acceptable and may be clearer).

```
let
  x = a
  y = b
```

You may also place the first clause alongside the 'let' as long as you indent the rest to line up:

wrong

```
let x = a
  y = b
```

wrong

```
let x = a
    y = b
```

right

```
let x = a
    y = b
```

This tends to trip up a lot of beginners: All *grouped* expressions must be exactly aligned. On the first line, Haskell counts everything to the left of the expression as indent, even though it is not whitespace.

Here are some more examples:

```
do
  foo
  bar
  baz

do foo
  bar
  baz
```

¹ See section 2.7 of The Haskell Report (lexemes) [^]{<http://www.haskell.org/onlinereport/lexemes.html#sect2.7>} on layout.

```

where x = a
      y = b

case x of
  p  -> foo
  p' -> baz

```

Note that with 'case' it is less common to place the first subsidiary expression on the same line as the 'case' keyword (although it would still be valid code). Hence, the subsidiary expressions in a case expression tend to be indented only one step further than the 'case' line. Also note how we lined up the arrows here: this is purely aesthetic and is not counted as different layout; only *indentation* (i.e. whitespace beginning on the far-left edge) makes a difference to the interpretation of the layout.

Things get more complicated when the beginning of an expression is not at the start of a line. In this case, it's safe to just indent further than the line containing the expression's beginning. In the following example, `do` comes at the end of a line, so the subsequent parts of the expression simply need to be indented relative to the line that contains the `do`, not relative to the `do` itself.

```

myFunction firstArgument secondArgument = do
  foo
  bar
  baz

```

Here are some alternative layouts which all work:

```

myFunction firstArgument secondArgument =
  do foo
    bar
    baz

myFunction firstArgument secondArgument = do foo
                                          bar
                                          baz

myFunction firstArgument secondArgument =
  do
    foo
    bar
    baz

```

23.2 Explicit characters in place of indentation

Indentation is actually optional if you instead use semicolons and curly braces for grouping and separation, as in "one-dimensional" languages like C. Even though the consensus among Haskell programmers is that meaningful indentation leads to better-looking code, understanding how to convert from one style to the other can help understand the indentation rules. The entire layout process can be summed up in three translation rules (plus a fourth one that doesn't come up very often):

1. If you see one of the layout keywords, (`let`, `where`, `of`, `do`), insert an open curly brace (right before the stuff that follows it)
2. If you see something indented to the SAME level, insert a semicolon
3. If you see something indented LESS, insert a closing curly brace

4. If you see something unexpected in a list, like `where`, insert a closing brace before instead of a semicolon.

For instance, this definition...

```
foo :: Double -> Double
foo x =
  let s = sin x
      c = cos x
  in 2 * s * c
```

...can be rewritten without caring about the indentation rules as:

```
foo :: Double -> Double;
foo x = let {
  s = sin x;
  c = cos x;
} in 2 * s * c
```

One circumstance in which explicit braces and semicolons can be convenient is when writing one-liners in GHCi:

```
Prelude> let foo :: Double -> Double; foo x = let { s = sin x; c = cos x } in 2
* s * c
```

Exercises:

Rewrite this snippet from the Control Structures chapter using explicit braces and semicolons:

```
doGuessing num = do
  putStrLn "Enter your guess:"
  guess <- getLine
  case compare (read guess) num of
    LT -> do putStrLn "Too low!"
          doGuessing num
    GT -> do putStrLn "Too high!"
          doGuessing num
    EQ -> putStrLn "You Win!"
```

23.3 Layout in action

wrong

```
do first thing
second thing
third thing
```

wrong

```
do first thing
  second thing
  third thing
```

right

```
do first thing
  second thing
  third thing
```

right

```
do
  first thing
  second thing
  third thing
```

23.3.1 Indent to the first

Due to the "golden rule of indentation" described above, a curly brace within a do block depends not on the do itself but the thing that immediately follows it. For example, this weird-looking block of code is totally acceptable:

```

    do
first thing
second thing
third thing

```

As a result, you could also write combined if/do combination like this:

Wrong	Right	Right
<pre> if foo then do first thing second thing third thing else do something_else </pre>	<pre> if foo then do first thing second thing third thing else do something_else </pre>	<pre> if foo then do first thing second thing third thing else do something_else </pre>

It isn't about the do, it's about lining up all the items that are at the same level within the do.

Thus, all of the following are acceptable:

```

main = do
  first thing
  second thing

```

OR

```

main =
  do
    first thing
    second thing

```

OR

```

main =
  do first thing
    second thing

```

23.3.2 if within do

This is a combination which trips up many Haskell programmers. Why does the following block of code not work?

sweet but wrong

unsweet and wrong

```
-- why is this bad?
do first thing
  if condition
  then foo
  else bar
  third thing
```

```
-- still bad, just explicitly so
do { first thing
    ; if condition
    ; then foo
    ; else bar
    ; third thing }
```

Naturally, the Haskell compiler is confused because it thinks that you never finished writing your `if` expression, before writing a new statement. The compiler sees that you have written something like `if condition;`, which is bad because it is unfinished. In order to fix this, we need to indent the bottom parts of this `if` block so that `then` and `else` become part of the `if` statement.

sweet and correct

```
-- whew, fixed it!
do first thing
  if condition
    then foo
    else bar
  third thing
```

unsweet and correct

```
-- the fixed version without sugar
do { first thing
    ; if condition
      then foo
      else bar
    ; third thing }
```

Now, the `do` block sees the whole `if` statement as one item. When `if-then-else` statements are not within `do` blocks, this specific indentation isn't technically necessary, but it never hurts, so it is a good habit to always indent `if-then-else` in this way.

Exercises:

The `if-within-do` issue has tripped up so many Haskellers that one programmer has posted a proposal^a to the Haskell prime initiative to add optional semicolons between `if then else`. How would that help?

^a <http://hackage.haskell.org/trac/haskell-prime/ticket/23>

Issues with indentation are explained further in connection with showing how `do` is syntactic sugar for the monadic operator (`>>=`). See [Translating the bind operator²](#) and the associated footnote about indentation³.

² Chapter 33.2 on page 208

³ Chapter 33.2 on page 208

24 More on datatypes

24.1 Enumerations

One special case of the data declaration is the *enumeration* — a data type where none of the constructor functions have any arguments:

```
data Month = January | February | March | April | May | June | July
           | August | September | October | November | December
```

You can mix constructors that do and do not have arguments, but then the result is not called an enumeration. The following example is *not* an enumeration because the last constructor takes three arguments:

```
data Colour = Black | Red | Green | Blue | Cyan
            | Yellow | Magenta | White | RGB Int Int Int
```

As you will see further on when we discuss classes and derivation, there are practical reasons to distinguish between what is and isn't an enumeration.

Incidentally, the Bool datatype is an enumeration:

```
data Bool = False | True
          deriving (Bounded, Enum, Eq, Ord, Read, Show)
```

24.2 Named Fields (Record Syntax)

Consider a datatype whose purpose is to hold configuration settings. Usually, when you extract members from this type, you really only care about one or two of the many settings. Moreover, if many of the settings have the same type, you might often find yourself wondering "wait, was this the fourth or *fifth* element?" One way to clarify is to write accessor functions. Consider the following made-up configuration type for a terminal program:

```
data Configuration = Configuration
  String -- User name
  String -- Local host
  String -- Remote host
  Bool   -- Is guest?
  Bool   -- Is superuser?
  String -- Current directory
  String -- Home directory
  Integer -- Time connected
  deriving (Eq, Show)
```

You could then write accessor functions, such as:

```
getUserName (Configuration un _ _ _ _ _ _) = un
```

```
getLocalHost (Configuration _ lh _ _ _ _ _) = lh
getRemoteHost (Configuration _ _ rh _ _ _ _ _) = rh
getIsGuest (Configuration _ _ _ ig _ _ _ _ _) = ig
-- And so on...
```

You could also write update functions to update a single element. Of course, if you add or remove an element in the configuration later, all of these functions now have to take a different number of arguments. This is quite annoying and is an easy place for bugs to slip in. Thankfully, there's a solution: we simply give names to the fields in the datatype declaration, as follows:

```
data Configuration = Configuration
  { username      :: String
  , localhost     :: String
  , remoteHost    :: String
  , isGuest       :: Bool
  , isSuperuser   :: Bool
  , currentDir    :: String
  , homeDir       :: String
  , timeConnected :: Integer
  }
```

This will automatically generate the following accessor functions for us:

```
username :: Configuration -> String
localhost :: Configuration -> String
-- etc.
```

This also gives us a convenient update method. Here is a short example for a "post working directory" and "change directory" functions that work on Configurations:

```
changeDir :: Configuration -> String -> Configuration
changeDir cfg newDir =
  if directoryExists newDir -- make sure the directory exists
  then cfg { currentDir = newDir }
  else error "Directory does not exist"

postWorkingDir :: Configuration -> String
postWorkingDir cfg = currentDir cfg
```

So, in general, to update the field x in a value y to z , you write $y \{ x = z \}$. You can change more than one; each should be separated by commas, for instance, $y \{ x = z, a = b, c = d \}$.

Note:

Those of you familiar with object-oriented languages might be tempted, after all of this talk about "accessor functions" and "update methods", to think of the $y\{x=z\}$ construct as a setter method, which modifies the value of x in a pre-existing y . It is **not** like that – remember that in Haskell variables are immutable^a. Therefore, using the example above, if you do something like `conf2 = changeDir conf1 "/opt/foo/bar"` `conf2` will be defined as a `Configuration` which is just like `conf1` except for having `"/opt/foo/bar"` as its `currentDir`, but `conf1` will remain unchanged.

^a Chapter 3.4 on page 11

24.2.1 It's only sugar

You can, of course, continue to pattern match against `Configuration` as you did before. The named fields are simply syntactic sugar; you can still write something like:

```
getUserName (Configuration un _ _ _ _ _ _) = un
```

But there is no need to do this.

Finally, you can pattern match against named fields as in:

```
getHostData (Configuration { localHost = lh, remoteHost = rh }) = (lh, rh)
```

This matches the variable `lh` against the `localHost` field in the `Configuration` and the variable `rh` against the `remoteHost` field. These matches will succeed, of course. You could also constrain the matches by putting values instead of variable names in these positions, as you would for standard datatypes.

If you are using GHC, then, with the language extension `NamedFieldPuns`, it is also possible to use this form:

```
getHostData (Configuration { localHost, remoteHost }) = (localHost, remoteHost)
```

It can be mixed with the normal form like this:

```
getHostData (Configuration { localHost, remoteHost = rh }) = (localHost, rh)
```

(To use this language extension, enter `:set -XNamedFieldPuns` in the interpreter, or use the `{-# LANGUAGE NamedFieldPuns #-}` pragma at the beginning of a source file, or pass the `-XNamedFieldPuns` command-line flag to the compiler.)

You can create values of `Configuration` in the old way as shown in the first definition below, or in the named field's type, as shown in the second definition:

```
initCFG = Configuration "nobody" "nowhere" "nowhere" False False "/" "/" 0

initCFG' = Configuration
  { username      = "nobody"
  , localHost     = "nowhere"
  , remoteHost    = "nowhere"
  , isguest       = False
  , issuperuser   = False
  , currentdir    = "/"
  , homedir       = "/"
  , timeConnected = 0
  }
```

The first way is much shorter, but the second is much clearer.

WARNING: The second style will allow you to write code that omits fields but will still compile, such as:

```
cfgFoo = Configuration { username = "Foo" }
cfgBar = Configuration { localHost = "Bar", remoteHost = "Baz" }
cfgUndef = Configuration {}
```

Trying to evaluate the unspecified fields will then result in a runtime error!

24.3 Parameterized Types

Parameterized types are similar to "generic" or "template" types in other languages. A parameterized type takes one or more type parameters. For example, the Standard Prelude type `Maybe` is defined as follows:

```
data Maybe a = Nothing | Just a
```

This says that the type `Maybe` takes a type parameter `a`. You can use this to declare, for example:

```
lookupBirthday :: [Anniversary] -> String -> Maybe Anniversary
```

The `lookupBirthday` function takes a list of birthday records and a string and returns a `Maybe Anniversary`. The usual interpretation of such a type is that if the name given through the string is found in the list of anniversaries the result will be `Just` the corresponding record; otherwise, it will be `Nothing`. `Maybe` is the simplest and most common way of indicating failure in Haskell. It is also sometimes seen in the types of function arguments, as a way to make them optional (the intent being that passing `Nothing` amounts to omitting the argument).

You can parameterize `type` and `newtype` declarations in exactly the same way. Furthermore you can combine parameterized types in arbitrary ways to construct new types.

24.3.1 More than one type parameter

We can also have more than one type parameter. An example of this is the `Either` type:

```
data Either a b = Left a | Right b
```

For example:

```
pairOff :: Int -> Either String Int
pairOff people
  | people < 0 = Left "Can't pair off negative number of people."
  | people > 30 = Left "Too many people for this activity."
  | even people = Right (people `div` 2)
  | otherwise = Left "Can't pair off an odd number of people."

groupPeople :: Int -> String
groupPeople people =
  case pairOff people of
    Right groups -> "We have " ++ show groups ++ " group(s)."
    Left problem -> "Problem! " ++ problem
```

In this example `pairOff` indicates how many groups you would have if you paired off a certain number of people for your activity. It can also let you know if you have too many people for your activity or if somebody will be left out. So `pairOff` will return either an `Int` representing the number of groups you will have, or a `String` describing the reason why you can't create your groups.

24.3.2 Kind Errors

The flexibility of Haskell parameterized types can lead to errors in type declarations that are somewhat like type errors, except that they occur in the type declarations rather than in the program proper. Errors in these "types of types" are known as "kind" errors. You don't program with kinds: the compiler infers them for itself. But if you get parameterized types wrong then the compiler will report a kind error.

25 Other data structures

In this chapter, we will work through examples of how the techniques we have studied thus far can be used to deal with more complex data types. In particular, we will see examples of *recursive data structures*, which are data types that can contain values of the same type. Recursive data structures play a vital role in many programming techniques, and so even if you are not going to need defining a new one often (as opposed to using the ones available from the libraries) it is important to be aware of what they are and how they can be manipulated. Besides that, following closely the implementations in this chapter is a good exercise for your budding Haskell abilities.

Note:

The Haskell library ecosystem provides a wealth of data structures (recursive and otherwise), covering a wide range of practical needs. Beyond lists, there are maps, sets, finite sequences and arrays, among many others. A good place to begin learning about the main ones is the Data structures primer^a in the Haskell in Practice track. We recommend you to at least skim it once you finish the next few Intermediate Haskell chapters.

^a <https://en.wikibooks.org/wiki/Haskell%2FLibraries%2FData%20structures%20primer>

25.1 Trees

One of the most important types of recursive data structures are *trees*. There are several different kinds of trees, so we will arbitrarily choose a simple one to use as an example. Here is its definition:

```
data Tree a = Leaf a | Branch (Tree a) (Tree a)
```

As you can see, it's parameterized; i.e. we can have trees of `Ints`, trees of `Strings`, trees of `Maybe Ints`, trees of `(Int, String)` pairs and so forth. What makes this data type special is that `Tree` appears in the definition of itself. A `Tree a` is either a *leaf*, containing a value of type `a` or a *branch*, from which hang two other trees of type `Tree a`.

25.1.1 Lists as Trees

As we have seen in More about lists¹ and List Processing², we break lists down into two cases: An empty list (denoted by `[]`), and an element of the specified type plus another list (denoted by `(x:xs)`). That means the definition of the list data type might look like this:

¹ <https://en.wikibooks.org/wiki/Haskell%2FMore%20about%20lists>

² https://en.wikibooks.org/wiki/Haskell%2FList_Processing

```
-- Pseudo-Haskell, will not actually work (because lists have special syntax).  
data [a] = [] | (a:[a])
```

An equivalent definition you can actually play with is:

```
data List a = Nil | Cons a (List a)
```

Like trees, lists are also recursive. For lists, the constructor functions are `[]` and `(:)`. They correspond to `Leaf` and `Branch` in the `Tree` definition above. That implies we can use `Leaf` and `Branch` for pattern matching just as we did with the empty list and the `(x:xs)`.

25.1.2 Maps and Folds

We already know about maps and folds for lists. Now, we can write map and fold functions for our new `Tree` type. To recap:

```
data Tree a = Leaf a | Branch (Tree a) (Tree a) deriving (Show)  
data [a] = [] | (:) a [a]  
-- (:) a [a] is the same as (a:[a]) with prefix instead of infix notation.
```

Note:

Deriving is explained later on in the section [Class Declarations^a](#). For now, understand it as telling Haskell (and by extension your interpreter) how to display a `Tree` instance.

^a Chapter 26 on page 165

Map

Let's take a look at the definition of `map` for lists:

```
map :: (a -> b) -> [a] -> [b]  
map _ [] = []  
map f (x:xs) = f x : map f xs
```

If we were to write `treeMap`, what would its type be? Defining the function is easier if you have an idea of what its type should be.

We want `treeMap` to work on a `Tree` of some type and return another `Tree` of some type by applying a function on each element of the tree.

```
treeMap :: (a -> b) -> Tree a -> Tree b
```

This is just like the list example.

Now, when talking about a `Tree`, each `Leaf` only contains a single value, so all we have to do is apply the given function to that value and then return a `Leaf` with the altered value:

```
treeMap :: (a -> b) -> Tree a -> Tree b  
treeMap f (Leaf x) = Leaf (f x)
```

This looks a lot like the empty list case with `map`. Now, if we have a `Branch`, it will include two subtrees; what do we do with those? The `list-map` uses a call to itself on the tail of the

list, so we also shall do that with the two subtrees. The complete definition of `treeMap` is as follows:

```
treeMap :: (a -> b) -> Tree a -> Tree b
treeMap f (Leaf x) = Leaf (f x)
treeMap f (Branch left right) = Branch (treeMap f left) (treeMap f right)
```

We can make this a bit more readable by noting that `treeMap f` is itself a function with type `Tree a -> Tree b`. This gives us the following revised definition:

```
treeMap :: (a -> b) -> Tree a -> Tree b
treeMap f = g where
  g (Leaf x) = Leaf (f x)
  g (Branch left right) = Branch (g left) (g right)
```

If you didn't follow that immediately, try re-reading it. This use of pattern matching may seem weird at first, but it is essential to the use of datatypes. Remember that pattern matching happens on constructor functions.

When you're ready, read on for folds over Trees.

Fold

As with `map`, let's first review the definition of `foldr` for lists:

```
foldr :: (a -> b -> b) -> b -> [a] -> b
foldr f acc [] = acc
foldr f acc (x:xs) = f x (foldr f acc xs)
```

Recall that lists have two constructors:

```
(:) :: a -> [a] -> [a] -- takes an element and combines it with the rest of the
  list
[] :: [a] -- the empty list takes zero arguments
```

Thus `foldr` takes two arguments corresponding to the two constructors:

```
f :: a -> b -> b -- a function takes two elements and operates on them to
  return a single result
acc :: b -- the accumulator defines what happens with the empty list
```

Let's take a moment to make this clear. If the initial `foldr` is given an empty list, then the default accumulator is returned. For functions like `(+)`, the initial accumulator will be `0`. With a non-empty list, the value returned by each fold is used in the next fold. When the list runs out, we are back at the empty list, so `foldr` returns whatever is *then* the accumulator value from the last fold.

Like `foldr` for lists, we want `treeFold` to transform a tree of some type into a value of some other type; so in place of `[a] -> b` we will have `Tree a -> b`. How do we specify the transformation? First note that `Tree a` has two constructors (just like lists have two constructors):

```
Branch :: Tree a -> Tree a -> Tree a
Leaf :: a -> Tree a
```

So `treeFold` will have two arguments corresponding to the two constructors:

```
fbranch :: b -> b -> b
fleaf  :: a -> b
```

Putting it all together we get the following type definition:

```
treeFold :: (b -> b -> b) -> (a -> b) -> Tree a -> b
```

That is, the first argument, of type `(b -> b -> b)`, is a function specifying how to combine subtrees into a single result; the second argument, of type `a -> b`, is a function specifying what to do with leaves (which are the end of recursion, just like empty-list for lists); and the third argument, of type `Tree a`, is the whole tree we want to fold.

As with `treeMap`, we'll avoid repeating the arguments `fbranch` and `fleaf` by introducing a local function `g`:

```
treeFold :: (b -> b -> b) -> (a -> b) -> Tree a -> b
treeFold fbranch fleaf = g where
  -- definition of g goes here
```

The argument `fleaf` tells us what to do with `Leaf` subtrees:

```
g (Leaf x) = fleaf x
```

The argument `fbranch` tells us how to combine the results of "folding" two subtrees:

```
g (Branch left right) = fbranch (g left) (g right)
```

Our full definition becomes:

```
treeFold :: (b -> b -> b) -> (a -> b) -> Tree a -> b
treeFold fbranch fleaf = g where
  g (Leaf x) = fleaf x
  g (Branch left right) = fbranch (g left) (g right)
```

For examples of how these work, copy the `Tree` data definition and the `treeMap` and `treeFold` functions to a Haskell file, along with the following example `Tree` and example functions to fold over.

```
tree1 :: Tree Integer
tree1 =
  Branch
    (Branch
      (Branch
        (Leaf 1)
        (Branch (Leaf 2) (Leaf 3)))
      (Branch
        (Leaf 4)
        (Branch (Leaf 5) (Leaf 6))))
    (Branch
      (Branch (Leaf 7) (Leaf 8))
      (Leaf 9))

doubleTree = treeMap (*2) -- doubles each value in tree
sumTree    = treeFold (+) id -- sum of the leaf values in tree
fringeTree = treeFold (++) (: []) -- list of the leaves of tree
```

Then load it into GHCi and evaluate:

```
doubleTree tree1
sumTree tree1
fringeTree tree1
```

25.2 Other datatypes

Map and fold functions can be defined for any kind of data type. In order to generalize the strategy applied for lists and trees, in this final section we will work out a map and a fold for a very strange, intentionally-contrived datatype:

```
data Weird a b = First a
               | Second b
               | Third [(a,b)]
               | Fourth (Weird a b)
```

It can be a useful exercise to write the functions as you follow the examples, trying to keep the coding one step ahead of your reading.

25.2.1 General Map

The first important difference in working with this `Weird` type is that it has *two* type parameters. For that reason, we will want the map function to take two functions as arguments, one to be applied on the elements of type `a` and another for the elements of type `b`. With that accounted for, we can write the type signature of `weirdMap`:

```
weirdMap :: (a -> c) -> (b -> d) -> Weird a b -> Weird c d
```

Next step is defining `weirdMap`. The key point is that maps preserve the *structure* of a datatype, so the function must evaluate to a `Weird` which uses the same constructor as the one used for the original `Weird`. For that reason, we need one definition to handle each constructor, and these constructors are used as patterns for writing them. As before, to avoid repeating the `weirdMap` argument list over and over again a **where** clause comes in handy. A sketch of the function is below:

```
weirdMap :: (a -> c) -> (b -> d) -> Weird a b -> Weird c d
weirdMap fa fb = g
  where
    g (First x)      = --More to follow
    g (Second y)    = --More to follow
    g (Third z)     = --More to follow
    g (Fourth w)    = --More to follow
```

The first two cases are fairly straightforward, as there is just a single element of `a` or `b` type inside the `Weird`.

```
weirdMap :: (a -> c) -> (b -> d) -> Weird a b -> Weird c d
weirdMap fa fb = g
  where
    g (First x)      = First (fa x)
    g (Second y)    = Second (fb y)
    g (Third z)     = --More to follow
    g (Fourth w)    = --More to follow
```

`Third` is trickier because it contains a list whose elements are themselves data structures (the tuples). So we need to navigate the nested data structures, apply `fa` and `fb` on all elements of type `a` and `b` and eventually (as a map must preserve structure) produce a list of tuples – `[(c,d)]` – to be used with the constructor. The simplest approach might seem to be just breaking down the list inside the `Weird` and playing with the patterns:

```
g (Third []) = Third []
g (Third ((x,y):zs)) = Third ( (fa x, fb y) : ( \(\Third z) -> z) (g (Third
zs)) ) )
```

This appears to be written as a typical recursive function for lists. We start by applying the functions of interest to the first element in order to obtain the head of the new list, `(fa x, fb y)`. But what will we cons it to? As `g` requires a `Weird` argument, we need to make a `Weird` using the list tail in order to make the recursive call. But then `g` will give a `Weird` and not a list, so we have to retrieve the modified list from that – that's the role of the lambda function. Finally, there is also the empty list base case to be defined as well.

After all of that, we are left with a messy function. Every recursive call of `g` requires wrapping `zs` into a `Weird`, while what we really wanted to do was to build a list with `(fa x, fb y)` and the modified `xs`. The problem with this solution is that `g` can (thanks to pattern matching) act directly on the list head but (due to its type signature) can't be called directly on the list tail. For that reason, it would be better to apply `fa` and `fb` without breaking down the list with pattern matching (as far as `g` is directly concerned, at least). But there *was* a way to directly modify a list element-by-element...

```
g (Third z) = Third ( map (\(x, y) -> (fa x, fb y) ) z)
```

...our good old `map` function, which modifies all tuples in the list `z` using a lambda function. In fact, the first attempt at writing the definition looked just like an application of the list `map` except for the spurious `Weird` packing and unpacking. We got rid of these by having the pattern splitting of `z` done by `map`, which works directly with regular lists. You could find it useful to expand the `map` definition inside `g` to see the difference more clearly. Finally, you may prefer to write this new version in an alternative and clean way using list comprehension syntax:

```
g (Third z) = Third [ (fa x, fb y) | (x,y) <- z ]
```

Adding the `Third` function, we only have the `Fourth` left to define:

```
weirdMap :: (a -> c) -> (b -> d) -> Weird a b -> Weird c d
weirdMap fa fb = g
  where
    g (First x)      = First (fa x)
    g (Second y)    = Second (fb y)
    g (Third z)     = Third ( map (\(x, y) -> (fa x, fb y) ) z)
    g (Fourth w)   = --More to follow
```

All we need to do is apply `g` recursively:

```
weirdMap :: (a -> c) -> (b -> d) -> Weird a b -> Weird c d
weirdMap fa fb = g
  where
    g (First x)      = First (fa x)
    g (Second y)    = Second (fb y)
```

```

g (Third z)      = Third ( map (\(x, y) -> (fa x, fb y) ) z)
g (Fourth w)    = Fourth (g w)

```

25.2.2 General Fold

While we were able to define a map by specifying as arguments a function for every separate type, this isn't enough for a fold. For a fold, we'll need a function for every constructor function. With lists, the constructors are [] and (:). The `acc` argument in the `foldr` function corresponds to the [] constructor. The `f` argument in the `foldr` function corresponds to the (:) constructor. The `Weird` datatype has four constructors, so we need four functions – one for handling the internal structure of the datatype specified by each constructor. Next, we have an argument of the `Weird a b` type, and finally we want the whole fold function to evaluate to a value of some other, arbitrary, type. Additionally, each individual function we pass to `weirdFold` must evaluate to the same type `weirdFold` does. That allows us to make a mock type signature and sketch the definition:

```

weirdFold :: (something1 -> c) -> (something2 -> c) -> (something3 -> c) ->
(something4 -> c) -> Weird a b -> c
weirdFold f1 f2 f3 f4 = g
  where
    g (First x)      = --Something of type c here
    g (Second y)    = --Something of type c here
    g (Third z)     = --Something of type c here
    g (Fourth w)    = --Something of type c here

```

Now, we need to figure out to which types `something1`, `something2`, `something3` and `something4` correspond to. That is done by analyzing the constructors, since the functions must take as arguments the elements of the datatype (whose types are specified by the constructor type signature). Again, the types and definitions of the first two functions are easy enough. The third one isn't too difficult either because, for the purposes of folding the list of (a,b), tuples are no different from a simple type (unlike in the map example, the *internal* structure does not concern us now). The fourth constructor, however, is recursive, and we have to be careful. As with `weirdMap`, we also need to recursively call the `g` function. This brings us to the final definition:

```

weirdFold :: (a -> c) -> (b -> c) -> [(a,b)] -> c -> (c -> c) -> Weird a b ->
c
weirdFold f1 f2 f3 f4 = g
  where
    g (First x)      = f1 x
    g (Second y)    = f2 y
    g (Third z)     = f3 z
    g (Fourth w)    = f4 (g w)

```

Note:

If you were expecting very complex expressions in the `weirdFold` above and are surprised by the immediacy of the solution, it might be helpful to have a look on what the common `foldr` would look like if we wrote it in this style and didn't have the special square-bracket syntax of lists to distract us:

```
-- List a is [a], Cons is (:) and Nil is []
data List a = Cons a (List a) | Nil

listFoldr :: (a -> b -> b) -> (b) -> List a -> b
listFoldr fCons fNil = g
  where
    g (Cons x xs) = fCons x (g xs)
    g Nil        = fNil
```

Now it is easier to see the parallels. The extra complications are that `Cons` (that is, `(:)`) takes two arguments (and, for that reason, so does `fCons`) and is recursive, requiring a call to `g`. Also, `fNil` is of course not really a function, as it takes no arguments.

Folds on recursive datatypes

As far as folds are concerned, `Weird` was a fairly nice datatype to deal with. Just one recursive constructor, which isn't even nested inside other structures. What would happen if we added a truly complicated fifth constructor?

```
Fifth [Weird a b] a (Weird a a, Maybe (Weird a b))
```

This is a valid and yet tricky question. In general, the following rules apply:

- A function to be supplied to a fold has the same number of arguments as the corresponding constructor.
- The type of the arguments of such a function match the types of the constructor arguments, *except* if the constructor is recursive (that is, takes an argument of its own type).
- If a constructor is recursive, any recursive argument of the constructor will correspond to an argument of the type the fold evaluates to.³
- If a constructor is recursive, the complete fold function should be (recursively) applied to the recursive constructor arguments.
- If a recursive element appears inside another data structure, the appropriate map function for that data structure should be used to apply the fold function to it.

So `f5` would have the type:

```
f5 :: [c] -> a -> (Weird a a, Maybe c) -> c
```

as the type of `Fifth` is:

³ This sort of recursiveness, in which the function used for folding can take the result of another fold as an argument, is what confers the folds of data structures such as lists and trees their "accumulating" functionality.

```
Fifth :: [Weird a b] -> a -> (Weird a a, Maybe (Weird a b)) -> Weird a b
```

The definition of `g` for the `Fifth` constructor will be:

```
g (Fifth list x (waa, mc)) = f5 (map g list) x (waa, maybeMap g mc)
  where
    maybeMap f Nothing = Nothing
    maybeMap f (Just w) = Just (f w)
```

Note that nothing strange happens with the `Weird a a` part. No `g` gets called. What's up? This is recursion, right? Well, not really. `Weird a a` and `Weird a b` are different types, so it isn't a real recursion. It isn't guaranteed that, for example, `f2` will work with something of type 'a', where it expects a type 'b'. It can be true for some cases but is not reliable for every case.

Also look at the definition of `maybeMap`. Verify that it is indeed a map function as:

- It preserves structure.
- Only types are changed.

A nice sounding word

The folds we have defined here are examples of *catamorphisms*. A catamorphism is a general way to collapse a data structure into a single value. There is deep theory associated with catamorphisms and related recursion schemes; however, we won't go through any of it now, as our main goal here was exercising the mechanics of data structure manipulation in Haskell with believable examples.

26 Classes and types

Back in Type basics II¹ we had a brief encounter with type classes as the mechanism used with number types. As we hinted back then, however, classes have many other uses.

Broadly speaking, the point of type classes is to ensure that certain operations will be available for values of chosen types. For example, if we know a type belongs to (or, to use the jargon, *instantiates*) the class `Fractional`, then we are guaranteed, among other things, to be able to perform real division with its values.²

26.1 Classes and instances

Up to now we have seen how existing type classes appear in signatures such as:

```
(==) :: (Eq a) => a -> a -> Bool
```

Now it is time to switch perspectives. First, we quote the definition of the `Eq` class from Prelude:

```
class Eq a where
  (==), (/=) :: a -> a -> Bool

  -- Minimal complete definition:
  --      (==) or (/=)
  x /= y    = not (x == y)
  x == y    = not (x /= y)
```

The definition states that if a type `a` is to be made an *instance* of the class `Eq` it must support the functions `(==)` and `(/=)` - the *class methods* - both of them having type `a -> a -> Bool`. Additionally, the class provides default definitions for `(==)` and `(/=)` *in terms of each other*. As a consequence, there is no need for a type in `Eq` to provide both definitions - given one of them, the other will be generated automatically.

With a class defined, we proceed to make existing types instances of it. Here is an arbitrary example of an algebraic data type made into an instance of `Eq` by an *instance declaration*:

```
data Foo = Foo {x :: Integer, str :: String}

instance Eq Foo where
  (Foo x1 str1) == (Foo x2 str2) = (x1 == x2) && (str1 == str2)
```

1 Chapter 7 on page 47

2 *To programmers coming from object-oriented languages*: A class in Haskell in all likelihood is *not* what you expect - don't let the terms confuse you. While some of the uses of type classes resemble what is done with abstract classes or Java interfaces, there are fundamental differences which will become clear as we advance.

And now we can apply (`==`) and (`/=`) to `Foo` values in the usual way:

```
• Main> Foo 3 "orange" == Foo 6 "apple" False
• Main> Foo 3 "orange" /= Foo 6 "apple" True
```

A few important remarks:

- The class `Eq` is defined in the Standard Prelude. This code sample defines the type `Foo` and then declares it to be an instance of `Eq`. The three definitions (class, data type, and instance) are *completely separate* and there is no rule about how they are grouped. This works both ways: you could just as easily create a new class `Bar` and then declare the type `Integer` to be an instance of it.
- *Classes are not types*, but categories of types; and so the instances of a class are types instead of values.³
- The definition of (`==`) for `Foo` relies on the fact that the values of its fields (namely `Integer` and `String`) are also members of `Eq`. In fact, almost all types in Haskell are members of `Eq` (the most notable exception being functions).
- Type synonyms defined with `type` keyword cannot be made instances of a class.

26.2 Deriving

Since equality tests between values are commonplace, in all likelihood most of the data types you create in any real program should be members of `Eq`. A lot of them will also be members of other Prelude classes such as `Ord` and `Show`. To avoid large amounts of boilerplate for every new type, Haskell has a convenient way to declare the "obvious" instance definitions using the keyword `deriving`. So, `Foo` would be written as:

```
data Foo = Foo {x :: Integer, str :: String}
  deriving (Eq, Ord, Show)
```

This makes `Foo` an instance of `Eq` with an automatically generated definition of `==` exactly equivalent to the one we just wrote, and also makes it an instance of `Ord` and `Show` for good measure.

You can only use `deriving` with a limited set of built-in classes, which are described *very* briefly below:

Eq

Equality operators `==` and `/=`

Ord

Comparison operators `<` `<=` `>` `>=`; `min`, `max`, and `compare`.

Enum

For enumerations only. Allows the use of list syntax such as `[Blue .. Green]`.

³ This is a key difference from most OO languages, where a class is also itself a type.

Bounded

Also for enumerations, but can also be used on types that have only one constructor. Provides `minBound` and `maxBound` as the lowest and highest values that the type can take.

Show

Defines the function `show`, which converts a value into a string, and other related functions.

Read

Defines the function `read`, which parses a string into a value of the type, and other related functions.

The precise rules for deriving the relevant functions are given in the language report. However, they can generally be relied upon to be the "right thing" for most cases. The types of elements inside the data type must also be instances of the class you are deriving.

This provision of special "magic" function synthesis for a limited set of predefined classes goes against the general Haskell philosophy that "built in things are not special", but it does save a lot of typing. Besides that, deriving instances stops us from writing them in the wrong way (an example: an instance of `Eq` such that `x == y` would not be equal to `y == x` would be flat out wrong).⁴

26.3 Class inheritance

Classes can inherit from other classes. For example, here is the main part of the definition of `Ord` in Prelude:

```
class (Eq a) => Ord a where
  compare      :: a -> a -> Ordering
  (<), (<=), (>=), (>) :: a -> a -> Bool
  max, min     :: a -> a -> a
```

The actual definition is rather longer and includes default implementations for most of the functions. The point here is that `Ord` inherits from `Eq`. This is indicated by the `=>` notation in the first line, which mirrors the way classes appear in type signatures. Here, it means that for a type to be an instance of `Ord` it must also be an instance of `Eq`, and hence needs to implement the `==` and `/=` operations.⁵

A class can inherit from several other classes: just put all of its superclasses in the parentheses before the `=>`. Let us illustrate that with yet another Prelude quote:

```
class (Num a, Ord a) => Real a where
  -- | the rational equivalent of its real argument with full precision
  toRational :: a -> Rational
```

⁴ There are ways to make the magic apply to other classes. GHC extensions allow `deriving` for a few other common classes for which there is only one correct way of writing the instances, and the GHC generics machinery make it possible to generate instances automatically for custom classes.

⁵ If you check the full definition in the Prelude [specification](http://hackage.haskell.org/packages/archive/base/4.1.0.0/doc/html/Prelude.html), the reason for that becomes clear: the default implementations involve applying `(==)` to the values being compared.

26.4 Standard classes

This diagram, adapted from the Haskell Report, shows the relationships between the classes and types in the Standard Prelude. The names in bold are the classes, while the non-bold text stands for the types that are instances of each class ($(->)$ refers to functions and $[]$, to lists). The arrows linking classes indicate the inheritance relationships, pointing to the inheriting class.

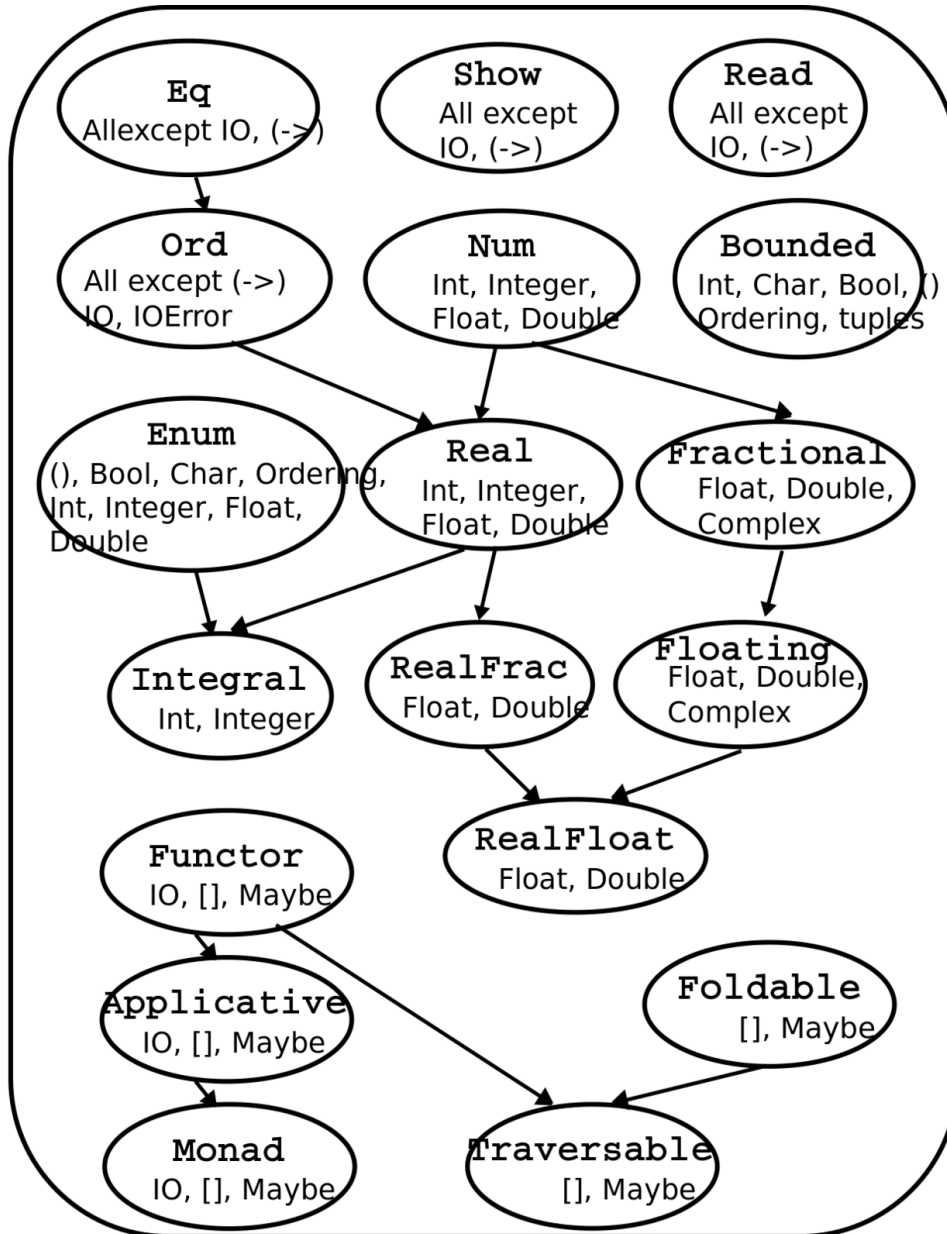

Figure 1 Summary of the hierarchy of base typeclasses

26.5 Type constraints

With all pieces in place, we can go full circle by returning to the very first example involving classes in this book:

```
(+) :: (Num a) => a -> a -> a
```

`(Num a) =>` is a *type constraint*, which restricts the type `a` to instances of the class `Num`. In fact, `(+)` is a method of `Num`, along with quite a few other functions (notably, `(*)` and `(-)`; but not `(/)`).

You can put several limits into a type signature like this:

```
foo :: (Num a, Show a, Show b) => a -> a -> b -> String
foo x y t =
  show x ++ " plus " ++ show y ++ " is " ++ show (x+y) ++ ". " ++ show t
```

Here, the arguments `x` and `y` must be of the same type, and that type must be an instance of both `Num` and `Show`. Furthermore, the final argument `t` must be of some (possibly different) type that is also an instance of `Show`. This example also displays clearly how constraints propagate from the functions used in a definition (in this case, `(+)` and `show`) to the function being defined.

26.5.1 Other uses

Beyond simple type signatures, type constraints can be introduced in a number of other places:

- instance declarations (typical with parametrized types);
- class declarations (constraints can be introduced in the method signatures in the usual way for any type variable other than the one defining the class⁶);
- data declarations,⁷ where they act as constraints for the constructor signatures.

⁶ Constraints for the type defining the class should be set via class inheritance.

⁷ And `newtype` declarations as well, but not `type`.

Note:

Type constraints in data declarations are less useful than it might seem at first. Consider:

```
data (Num a) => Foo a = F1 a | F2 a String
```

Here, `Foo` is a type with two constructors, both taking an argument of a type `a` which must be in `Num`. However, the `(Num a) =>` constraint is only effective for the `F1` and `F2` constructors, and not for other functions involving `Foo`. Therefore, in the following example...

```
fooSquared :: (Num a) => Foo a -> Foo a
fooSquared (F1 x) = F1 (x * x)
fooSquared (F2 x s) = F2 (x * x) s
```

... even though the constructors ensure `a` will be some type in `Num` we can't avoid duplicating the constraint in the signature of `fooSquared`.^a

^a *Extra note for the curious:* This issue is related to some of the problems tackled by the advanced features discussed in the "Fun with types" chapter of the Advanced Track.

26.6 A concerted example

To provide a better view of the interplay between types, classes, and constraints, we will present a very simple and somewhat contrived example. We will define a `Located` class, a `Movable` class which inherits from it, and a function with a `Movable` constraint implemented using the methods of the parent class, i.e. `Located`.

```
-- Location, in two dimensions.
class Located a where
  getLocation :: a -> (Int, Int)

class (Located a) => Movable a where
  setLocation :: (Int, Int) -> a -> a

-- An example type, with accompanying instances.
data NamedPoint = NamedPoint
  { pointName :: String
  , pointX    :: Int
  , pointY    :: Int
  } deriving (Show)

instance Located NamedPoint where
  getLocation p = (pointX p, pointY p)

instance Movable NamedPoint where
  setLocation (x, y) p = p { pointX = x, pointY = y }

-- Moves a value of a Movable type by the specified displacement.
-- This works for any movable, including NamedPoint.
move :: (Movable a) => (Int, Int) -> a -> a
move (dx, dy) p = setLocation (x + dx, y + dy) p
  where
    (x, y) = getLocation p
```

26.6.1 A word of advice

Do not read too much into the `Movable` example just above; it is merely a demonstration of class-related language features. It would be a mistake to think that every single functionality which might be conceivably generalized, such as `setLocation`, needs a type class of its own. In particular, if all your `Located` instances should be able to be moved as well then `Movable` is unnecessary - and if there is just one instance there is no need for type classes at all! Classes are best used when there are several types instantiating it (or if you expect others to write additional instances) and you do not want users to know or care about the differences between the types. An extreme example would be `Show`: general-purpose functionality implemented by an immense number of types, about which you do not need to know a thing about before calling `show`. In the following chapters, we will explore a number of important type classes in the libraries; they provide good examples of the sort of functionality which fits comfortably into a class.

27 The Functor class

In this chapter, we will introduce the important `Functor` type class.

27.1 Motivation

In Other data structures¹, we saw operations that apply to all elements of some grouped value. The prime example is `map` which works on lists. Another example we worked through was the following `Tree` datatype:

```
data Tree a = Leaf a | Branch (Tree a) (Tree a) deriving (Show)
```

The `map` function we wrote for `Tree` was:

```
treeMap :: (a -> b) -> Tree a -> Tree b
treeMap f (Leaf x)           = Leaf (f x)
treeMap f (Branch left right) = Branch (treeMap f left) (treeMap f right)
```

As discussed before, we can conceivably define a map-style function for any arbitrary data structure.

When we first introduced `map` in Lists II², we went through the process of taking a very specific function for list elements and generalizing to show how `map` combines any appropriate function with all sorts of lists. Now, we will generalize still *further*. Instead of map-for-lists and map-for-trees and other distinct maps, how about a general concept of maps for all sorts of mappable types?

27.2 Introducing Functor

`Functor` is a Prelude class for types which can be mapped over. It has a single method, called `fmap`. The class is defined as follows:

```
class Functor f where
  fmap :: (a -> b) -> f a -> f b
```

The usage of the type variable `f` can look a little strange at first. Here, `f` is a parametrized data type; in the signature of `fmap`, `f` takes `a` as a type parameter in one of its appearances and `b` in the other. Let's consider an instance of `Functor`: By replacing `f` with `Maybe` we get the following signature for `fmap`...

```
fmap :: (a -> b) -> Maybe a -> Maybe b
```

1 Chapter 25 on page 155

2 Chapter 13 on page 87

... which fits the natural definition:

```
instance Functor Maybe where
  fmap f Nothing = Nothing
  fmap f (Just x) = Just (f x)
```

(Incidentally, this definition is in Prelude; so we didn't really need to implement `maybeMap` for that example in the "Other data structures" chapter.)

The `Functor` instance for lists (also in Prelude) is simple:

```
instance Functor [] where
  fmap = map
```

... and if we replace `f` with `[]` in the `fmap` signature, we get the familiar type of `map`.

So, `fmap` is a generalization of `map` for any parametrized data type.³

Naturally, we can provide `Functor` instances for our own data types. In particular, `treeMap` can be promptly relocated to an instance:

```
instance Functor Tree where
  fmap f (Leaf x) = Leaf (f x)
  fmap f (Branch left right) = Branch (fmap f left) (fmap f right)
```

Here's a quick demo of `fmap` in action with the instances above (to reproduce it, you only need to load the `data` and `instance` declarations for `Tree`; the others are already in Prelude):

```
• Main> fmap (2*) [1,2,3,4] [2,4,6,8]
• Main> fmap (2*) (Just 1) Just 2
• Main> fmap (fmap (2*)) [Just 1, Just 2, Just 3, Nothing] [Just 2, Just 4, Just 6, Nothing]
• Main> fmap (2*) (Branch (Branch (Leaf 1) (Leaf 2)) (Branch (Leaf 3) (Leaf 4))) Branch (Branch
  (Leaf 2) (Leaf 4)) (Branch (Leaf 6) (Leaf 8))
```

Note:

Beyond `[]` and `Maybe`, there are many other `Functor` instances already defined. Those made available from the Prelude are listed in the `Data.Functora` module.

^a <http://hackage.haskell.org/packages/archive/base/latest/doc/html/Data-Functor.html>

27.2.1 The functor laws

When providing a new instance of `Functor`, you should ensure it satisfies the two functor laws. There is nothing mysterious about these laws; their role is to guarantee `fmap` behaves sanely and actually performs a mapping operation (as opposed to some other nonsense).⁴ The first law is:

³ Data structures provide the most intuitive examples; however, there are functors which cannot reasonably be seen as data structures. A commonplace metaphor consists in thinking of functors as containers; like all metaphors, however, it can be stretched only so far.

⁴ Some examples of nonsense that the laws rule out: removing or adding elements from a list, reversing a list, changing a `Just`-value into a `Nothing`.

```
fmap id = id
```

`id` is the identity function, which returns its argument unaltered. The first law states that mapping `id` over a functorial value must return the functorial value unchanged.

Next, the second law:

```
fmap (g . f) = fmap g . fmap f
```

It states that it should not matter whether we map a composed function or first map one function and then the other (assuming the application order remains the same in both cases).

27.3 What did we gain?

At this point, we can ask what benefit we get from the extra layer of generalization brought by the `Functor` class. There are two significant advantages:

- The availability of the `fmap` method relieves us from having to recall, read, and write a plethora of differently named mapping methods (`maybeMap`, `treeMap`, `weirdMap`, *ad infinitum*). As a consequence, code becomes both cleaner and easier to understand. On spotting a use of `fmap`, we instantly have a general idea of what is going on.⁵ Thanks to the guarantees given by the functor laws, this general idea is surprisingly precise.
- Using the type class system, we can write `fmap`-based algorithms which work out of the box with *any* functor - be it `[]`, `Maybe`, `Tree` or whichever you need. Indeed, a number of useful classes in the core libraries inherit from `Functor`.

Type classes make it possible to create general solutions to whole categories of problems. Depending on what you use Haskell for, you may not need to define new classes often, but you will certainly be *using* type classes all the time. Many of the most powerful features and sophisticated capabilities of Haskell rely on type classes (residing either in the standard libraries or elsewhere). From this point on, classes will be a prominent presence in our studies.

⁵ This is analogous to the gain in clarity provided by replacing explicit recursive algorithms on lists with implementations based on higher-order functions.

28 Monads

29 Prologue: IO, an applicative functor

For shorter links to this chapter, be them within the book or off-wiki, you can use the Haskell/Applicative prologue¹ redirect.

The emergence of functors is a watershed in the course of this book. The reasons for that will begin to reveal themselves in this prologue, as we set the stage for the next several chapters of the book. While the code examples we will work with here are very simple, we will use them to bring several new and important ideas into play, ideas that will be revisited and further developed later in the book. That being so, we recommend you to study this chapter at a gentle pace, which gives you space for thinking about the implications of each step, as well as trying out the code samples in GHCi.

29.1 Scene 1 : Applicative

Our initial examples will use the function `readMaybe`, which is provided by the `Text.Read` module.

```
GHCi> :m +Text.Read
GHCi> :t readMaybe
readMaybe :: Read a => String -> Maybe a
```

`readMaybe` provides a simple way of converting strings into Haskell values. If the provided string has the correct format to be read as a value of type `a`, `readMaybe` gives back the converted value wrapped in `Just`; otherwise, the result is `Nothing`.

```
GHCi> readMaybe "3" :: Maybe Integer
Just 3
GHCi> readMaybe "foo" :: Maybe Integer
Nothing
GHCi> readMaybe "3.5" :: Maybe Integer
Nothing
GHCi> readMaybe "3.5" :: Maybe Double
Just 3.5
```

Note:

To use `readMaybe`, we need to specify which type we are trying to read. Most of the time, that would be done through a combination of type inference and the signatures in our code. Occasionally, however, it is more convenient to just slap in a *type annotation* rather than writing down a proper signature. For instance, in the first example above the `:: Maybe Integer` in `readMaybe "3" :: Maybe Integer` says that the type of `readMaybe "3"` is `Maybe Integer`.

We can use `readMaybe` to write a little program in the style of those in the Simple input and output² chapter that:

- Gets a string given by the user through the command line;
- Tries to read it into a number (let's use `Double` as the type); and
- If the read succeeds, prints the double of the number; otherwise, prints an explanatory message and starts over.

Note:

Before continuing, we suggest you try writing the program. Beyond `readMaybe`, you will likely find `getLine`, `putStrLn` and `show` useful. Have a look at the Simple input and output^a chapter if you need a reminder about how to do reading from and printing to the console.

^a Chapter 10 on page 67

Here is a possible implementation:

```
import Text.Read

interactiveDoubling = do
  putStrLn "Choose a number:"
  s <- getLine
  let mx = readMaybe s :: Maybe Double
  case mx of
    Just x -> putStrLn ("The double of your number is " ++ show (2*x))
    Nothing -> do
      putStrLn "This is not a valid number. Retrying..."
      interactiveDoubling
```

```
GHCi> interactiveDoubling
Choose a number:
foo
This is not a valid number. Retrying...
Choose a number:
3
The double of your number is 6.0
```

Nice and simple. A variation of this solution might take advantage of how, given that `Maybe` is a `Functor`, we can double the value before unwrapping `mx` in the case statement:

```
interactiveDoubling = do
  putStrLn "Choose a number:"
  s <- getLine
  let mx = readMaybe s :: Maybe Double
  case fmap (2*) mx of
    Just d -> putStrLn ("The double of your number is " ++ show d)
    Nothing -> do
      putStrLn "This is not a valid number. Retrying..."
      interactiveDoubling
```

In this case, there is no real advantage in doing that. Still, keep this possibility in mind.

² Chapter 10 on page 67

29.1.1 Application in functors

Now, let's do something slightly more sophisticated: reading two numbers with `readMaybe` and printing their sum (we suggest that you attempt writing this one as well before continuing).

Here is one solution:

```
interactiveSumming = do
  putStrLn "Choose two numbers:"
  sx <- getLine
  sy <- getLine
  let mx = readMaybe sx :: Maybe Double
      my = readMaybe sy
  case mx of
    Just x -> case my of
      Just y -> putStrLn ("The sum of your numbers is " ++ show (x+y))
      Nothing -> retry
    Nothing -> retry
  where
  retry = do
    putStrLn "Invalid number. Retrying..."
    interactiveSumming
```

```
GHCi> interactiveSumming
Choose two numbers:
foo
4
Invalid number. Retrying...
Choose two numbers:
3
foo
Invalid number. Retrying...
Choose two numbers:
3
4
The sum of your numbers is 7.0
```

`interactiveSumming` works, but it is somewhat annoying to write. In particular, the nested case statements are not pretty, and make reading the code a little difficult. If only there was a way of summing the numbers before unwrapping them, analogously to what we did with `fmap` in the second version of `interactiveDoubling`, we would be able to get away with just one case:

```
-- Wishful thinking...
case somehowSumMaybes mx my of
  Just z -> putStrLn ("The sum of your numbers is " ++ show z)
  Nothing -> do
    putStrLn "Invalid number. Retrying..."
    interactiveSumming
```

But what should we put in place of `somehowSumMaybes`? `fmap`, for one, is not enough. While `fmap (+)` works just fine to partially apply `(+)` to the value wrapped by `Maybe`...

```
GHCi> :t (+) 3
(+) 3 :: Num a => a -> a
GHCi> :t fmap (+) (Just 3)
fmap (+) (Just 3) :: Num a => Maybe (a -> a)
```

... we don't know how to apply a function wrapped in `Maybe` to the second value. For that, we would need a function with a signature like this one...

```
(<*>) :: Maybe (a -> b) -> Maybe a -> Maybe b
```

... which would then be used like this:

```
GHCi> fmap (+) (Just 3) <*> Just 4
Just 7
```

The GHCi prompt in this example, however, is not wishful thinking: (<*>) actually exists, and if you try it in GHCi, it will actually work! The expression looks even neater if we use the infix synonym of `fmap`, (<\$>):

```
GHCi> (+) <$> Just 3 <*> Just 4
Just 7
```

The actual type (<*>) is more general than what we just wrote. Checking it...

```
GHCi> :t (<*>)
(<*>) :: Applicative f => f (a -> b) -> f a -> f b
```

... introduces us to a new type class: `Applicative`, the type class of *applicative functors*. For an initial explanation, we can say that an applicative functor is a functor which supports applying functions within the functor, thus allowing for smooth usage of partial application (and therefore functions of multiple arguments). All instances of `Applicative` are `Functors`, and besides `Maybe`, there are many other common `Functors` which are also `Applicative`.

This is the `Applicative` instance for `Maybe`:

```
instance Applicative Maybe where
  pure = Just
  (Just f) <*> (Just x) = Just (f x)
  _ <*> _ = Nothing
```

The definition of (<*>) is actually quite simple: if neither of the values are `Nothing`, apply the function `f` to `x` and wrap the result with `Just`; otherwise, give back `Nothing`. Note that the logic is exactly equivalent to what the nested `case` statement of `interactiveSumming` does.

Note that beyond (<*>) there is a second method in the instance above, `pure`:

```
GHCi> :t pure
pure :: Applicative f => a -> f a
```

`pure` takes a value and brings it into the functor in a default, trivial way. In the case of `Maybe`, the trivial way amounts to wrapping the value with `Just` – the nontrivial alternative would be discarding the value and giving back `Nothing`. With `pure`, we might rewrite the three-plus-four example above as...

```
GHCi> (+) <$> pure 3 <*> pure 4 :: Num a => Maybe a
Just 7
```

... or even:

```
GHCi> pure (+) <*> pure 3 <*> pure 4 :: Num a => Maybe a
Just 7
```

Just like the `Functor` class has laws which specify how sensible instance should behave, there is a set of laws for `Applicative`. Among other things, these laws specify what the "trivial" way of bringing values into the functor through `pure` amounts to. Since there is a lot going on in this stretch of the book, we will not discuss the laws now; however, we will return to this important topic in a not too distant future.

Note:

In any case, if you are curious feel free to make a detour though the `Applicative functors`^a chapter and read its "Applicative functor laws" subsection. If you choose to go there, you might as well have a look at the "ZipList" section, which provides an additional example of a common applicative functor that can be grasped using only what we have seen so far.

^a Chapter 40 on page 261

To wrap things up, here is a version of `interactiveSumming` enhanced by `(<*>)`:

```
interactiveSumming = do
  putStrLn "Choose two numbers:"
  sx <- getLine
  sy <- getLine
  let mx = readMaybe sx :: Maybe Double
      my = readMaybe sy
  case (+) <$> mx <*> my of
    Just z -> putStrLn ("The sum of your numbers is " ++ show z)
    Nothing -> do
      putStrLn "Invalid number. Retrying..."
      interactiveSumming
```

29.2 Scene 2 : IO

In the examples above, we have been taking I/O actions such as `getLine` for granted. We now find ourselves at an auspicious moment to revisit a question first raised many chapters ago: what is the type of `getLine`?

Back in the Simple input and output³ chapter, we saw the answer to that question is:

```
GHCi> :t getLine
getLine :: IO String
```

Using what we learned since then, we can now see that `IO` is a type constructor with one type variable, which happens to be instantiated as `String` in the case of `getLine`. That, however, doesn't get to the root of the issue: what does `IO String` really mean, and what is the difference between that and plain old `String`?

29.2.1 Referential transparency

A key feature of Haskell is that all expressions we can write are *referentially transparent*. That means we can replace any expression whatsoever by its value without changing the behaviour of the program. For instance, consider this very simple program:

³ Chapter 10 on page 67

```
addExclamation :: String -> String
addExclamation s = s ++ "!"

main = putStrLn (addExclamation "Hello")
```

Its behaviour is wholly unsurprising:

```
GHCi> main
Hello!
```

Given that `addExclamation s = s ++ "!"`, we can rewrite `main` so that it doesn't mention `addExclamation`. All we have to do is replacing `s` by `"Hello"` in the right-hand side of the `addExclamation` definition and then replacing `addExclamation "Hello!"` by the resulting expression. As advertised, the program behaviour does not change:

```
GHCi> let main = putStrLn ("Hello" ++ "!")
GHCi> main
Hello!
```

Referential transparency ensures that this sort of substitution works. This guarantee extends to anywhere in any Haskell program, which goes a long way towards making programs easier to understand, and their behaviour easier to predict.

Now, suppose that the type of `getLine` were `String`. In that case, we would be able to use it as the argument to `addExclamation`, as in:

```
-- Not actual code.
main = putStrLn (addExclamation getLine)
```

In that case, however, a new question would spring forth: if `getLine` is a `String`, which `String` is it? There is no satisfactory answer: it could be `"Hello"`, `"Goodbye"`, or whatever else the user chooses to type at the terminal. And yet, *replacing* `getLine` by any `String` breaks the program, as the user would not be able to type the input string at the terminal any longer. Therefore `getLine` having type `String` would cause referential transparency to be broken. The same goes for all other I/O actions: their results are *opaque*, in that it is impossible to tell them in advance, as they depend on factors external to the program.

29.2.2 Cutting through the fog

As `getLine` illustrates, there is a fundamental indeterminacy associated with I/O actions. Respecting this indeterminacy is necessary for preserving referential transparency. In Haskell, that is achieved through the IO type constructor. `getLine` being an IO `String` means that it is not any actual `String`, but both a placeholder for a `String` that will only materialise when the program is executed and a promise that this `String` will indeed be delivered (in the case of `getLine`, by slurping it from the terminal). As a consequence, when we manipulate an IO `String` we are setting up plans for what *will* be done once this unknown `String` comes into being. There are quite a few ways of achieving that. In this section, we will consider two of them; to which we will add a third one in the next few chapters.

The idea of dealing a value which isn't really there might seem bizarre at first. However, we have already discussed at least one example of something not entirely unlike it without batting an eyelid. If `mx` is a `Maybe Double`, then `fmap (2*) mx` doubles the value *if it is there*, and works regardless of whether the value actually exists.⁴ Both `Maybe a` and `IO a` imply, for different reasons, a layer of indirection in reaching the corresponding values of type `a`. That being so, it comes as no surprise that, like `Maybe`, *IO is a Functor*, with `fmap` being the most elementary way of getting across the indirection.

To begin with, we can exploit the fact of `IO` being a `Functor` to replace the `let` definitions in `interactiveSumming` from the end of the previous section by something more compact:

```
interactiveSumming :: IO ()
interactiveSumming = do
  putStrLn "Choose two numbers:"
  mx <- readMaybe <$> getLine -- equivalently: fmap readMaybe getLine
  my <- readMaybe <$> getLine
  case (+) <$> mx <*> my :: Maybe Double of
    Just z -> putStrLn ("The sum of your numbers is " ++ show z)
    Nothing -> do
      putStrLn "Invalid number. Retrying..."
      interactiveSumming
```

`readMaybe <$> getLine` can be read as "once `getLine` delivers a string, whatever it turns out to be, apply `readMaybe` on it". Referential transparency is not compromised: the value behind `readMaybe <$> getLine` is just as opaque as that of `getLine`, and its type (in this case `IO (Maybe Double)`) disallows us from replacing it with any determinate value (say, `Just 3`) that would violate referential transparency.

Beyond being a `Functor`, `IO` is also an `Applicative`, which provides us a second way of manipulating the values delivered by I/O actions. We will illustrate it with a `interactiveConcatenating` action, similar in spirit to `interactiveSumming`. A first version is just below. Can you anticipate how to simplify it with `<*>`?

```
interactiveConcatenating :: IO ()
interactiveConcatenating = do
  putStrLn "Choose two strings:"
  sx <- getLine
  sy <- getLine
  putStrLn "Let's concatenate them:"
  putStrLn (sx ++ sy)
```

Here is a version exploiting `<*>`:

```
interactiveConcatenating :: IO ()
interactiveConcatenating = do
  putStrLn "Choose two strings:"
  sz <- (++) <$> getLine <*> getLine
  putStrLn "Let's concatenate them:"
  putStrLn sz
```

`(++) <$> getLine <*> getLine` is an I/O action which is made out of two other I/O actions (the two `getLine`). When it is executed, these two I/O actions are executed and the strings they deliver are concatenated. One important thing to notice is that `<*>` maintains

⁴ The key difference between the two situations is that with `Maybe` the indeterminacy is only apparent, and it is possible to figure out in advance whether there is an actual `Double` behind `mx` – or, more precisely, it is possible as long as the value of `mx` does not depend on I/O!

a consistent order of execution between the actions it combines. Order of execution matters when dealing with I/O – examples of that are innumerable, but for starters consider this question: if we replace the second `getLine` in the example above with `(take 3 <$> getLine)`, which of the strings entered at the terminal will be cut down to three characters?

As `(<*>)` respects the order of actions, it provides a way of sequencing them. In particular, if we are only interested in sequencing and don't care about the result of the first action we can use `_ y -> y` to discard it:

```
GHCi> (\_ y -> y) <$> putStrLn "First!" <*> putStrLn "Second!"
First!
Second!
```

This is such a common usage pattern that there is an operator specifically for it: `(>*)`.

```
u *> v = (\_ y -> y) <$> u <*> v
```

```
GHCi> :t (>*)
(>*) :: Applicative f => f a -> f b -> f b
GHCi> putStrLn "First!" *> putStrLn "Second!"
First!
Second!
```

It can be readily applied to `interactiveConcatenating` example:

```
interactiveConcatenating :: IO ()
interactiveConcatenating = do
  putStrLn "Choose two strings:"
  sz <- (++) <$> getLine <*> getLine
  putStrLn "Let's concatenate them:" *> putStrLn sz
```

Or, going even further:

```
interactiveConcatenating :: IO ()
interactiveConcatenating = do
  sz <- putStrLn "Choose two strings:" *> ((++) <$> getLine <*> getLine)
  putStrLn "Let's concatenate them:" *> putStrLn sz
```

Note that each of the `(>*)` replaces one of the magical line breaks of the `do` block that lead actions to be executed one after the other. In fact, that is all there is to the replaced line breaks: they are just syntactic sugar for `(>*)`.

Earlier, we said that a functor brings in a layer of indirection for accessing the values within it. The flip side of that observation is that the indirection is caused by a *context*, within which the values are found. For `IO`, the indirection is that the values are only determined when the program is executed, and the context consists in the series of instructions that will be used to produce these values (in the case of `getLine`, these instructions amount to "slurp a line of text from the terminal"). From this perspective, `(<*>)` takes two functorial values and combines not only the values within but also the contexts themselves. In the case of `IO` combining the contexts means appending the instructions of one I/O action to those of the other, thus sequencing the actions.

29.3 The end of the beginning

This chapter was a bit of a whirlwind! Let's recapitulate the key points we discussed in it:

- `Applicative` is a subclass of `Functor` for *applicative functors*, which are functors that support function application without leaving the functor.
- The `(<*>)` method of `Applicative` can be used as a generalisation of `fmap` to multiple arguments.
- An `IO a` is not a tangible value of type `a`, but a placeholder for an `a` value that will only come into being when the program is executed and a promise that this value will be delivered through some means. That makes referential transparency possible even when dealing with I/O actions.
- `IO` is a functor, and more specifically an instance of `Applicative`, that provides means to modify the value produced by an I/O action in spite of its indeterminacy.
- A functorial value can be seen as being made of values in a *context*. `fmap` cuts through the context to modify the underlying values. `(<*>)` combines both the contexts and the underlying values of two functorial values.
- In the case of `IO`, `(<*>)`, and the closely related `(*>)`, combine contexts by sequencing I/O actions.
- A large part of the role of `do` blocks is simply providing syntactic sugar for `(*>)`.

As a final observation, note that there is still a major part of the mystery behind `do` blocks left to explain: what does the left arrow do? In a `do`-block line such as...

```
sx <- getLine
```

... it looks like we are extracting the value produced by `getLine` from the `IO` context. Thanks to the discussion about referential transparency, we now know that must be an illusion. But what is going on behind the scenes? Feel free to place your bets, as we are about to find out!

30 Understanding monads

There is a certain mystique about monads, and even about the word "monad" itself. While one of our goals of this set of chapters is removing the shroud of mystery that is often wrapped around them, it is not difficult to understand how it comes about. Monads are very useful in Haskell, but the concept is often difficult to grasp at first. Since monads have so many applications, people often explain them from a particular point of view, which can derail your efforts towards understanding them in their full glory.

Historically, monads were introduced into Haskell to perform input and output – that is, I/O operations of the sort we dealt with in the Simple input and output¹ chapter and the prologue to this unit². A predetermined execution order is crucial for things like reading and writing files, and monadic operations lend themselves naturally to sequencing. However, monads are by no means limited to input and output. They can be used to provide a whole range of features, such as exceptions, state, non-determinism, continuations, coroutines, and more. In fact, thanks to the versatility of monads, none of these constructs needed to be built into Haskell as a language; rather, they are defined by the standard libraries.

In the Prologue³ chapter, we began with an example and used it to steadily introduce several new ideas. Here, we will do it the other way around, starting with a definition of monad and, from that, building connections with what we already know.

30.1 Definition

A *monad* is defined by three things:

- a type constructor⁴ `m`;
- a function `return`;⁵
- an operator `(>>=)` which is pronounced "bind".

The function and operator are methods of the `Monad` type class and have types

```
return :: a -> m a
(>>=)  :: m a -> (a -> m b) -> m b
```

and are required to obey three laws⁶ that will be explained later on.

1 Chapter 10 on page 67

2 <https://en.wikibooks.org/wiki/Haskell%2FApplicative%20prologue>

3 <https://en.wikibooks.org/wiki/Haskell%2FApplicative%20prologue>

4 Chapter 24.3 on page 152

5 This `return` function has nothing to do with the `return` keyword found in imperative languages like C or Java; don't conflate these two.

6 Chapter 30.3 on page 195

For a concrete example, take the `Maybe` monad. The type constructor is `m = Maybe`, while `return` and `(>>=)` are defined like this:

```
return :: a -> Maybe a
return x = Just x

(>>=) :: Maybe a -> (a -> Maybe b) -> Maybe b
m >>= g = case m of
  Nothing -> Nothing
  Just x  -> g x
```

`Maybe` is the monad, and `return` brings a value into it by wrapping it with `Just`. As for `(>>=)`, it takes a `m :: Maybe a` value and a `g :: a -> Maybe b` function. If `m` is `Nothing`, there is nothing to do and the result is `Nothing`. Otherwise, in the `Just x` case, `g` is applied to `x`, the underlying value wrapped in `Just`, to give a `Maybe b` result. Note that this result may or may not be `Nothing`, depending on what `g` does to `x`. To sum it all up, if there is an *underlying value* of type `a` in `m`, we apply `g` to it, which brings the underlying value back into the `Maybe` monad.

The key first step to understand how `return` and `(>>=)` work is tracking which values and arguments are monadic and which ones aren't. As in so many other cases, type signatures are our guide to the process.

30.1.1 Motivation: Maybe

To see the usefulness of `(>>=)` and the `Maybe` monad, consider the following example: Imagine a family database that provides two functions:

```
father :: Person -> Maybe Person
mother :: Person -> Maybe Person
```

These look up the name of someone's father or mother. In case our database is missing some relevant information, `Maybe` allows us to return a `Nothing` value to indicate that the lookup failed, rather than crashing the program.

Let's combine our functions to query various grandparents. For instance, the following function looks up the maternal grandfather (the father of one's mother):

```
maternalGrandfather :: Person -> Maybe Person
maternalGrandfather p =
  case mother p of
    Nothing -> Nothing
    Just mom -> father mom
```

Or consider a function that checks whether both grandfathers are in the database:

```
bothGrandfathers :: Person -> Maybe (Person, Person)
bothGrandfathers p =
  case father p of
    Nothing -> Nothing
    Just dad ->
      case father dad of
        Nothing -> Nothing
        Just gf1 ->
          grandfather gf1 -- found first

grandfather :: Person -> Maybe Person
grandfather p =
  case mother p of
    Nothing -> Nothing
```

```

    Just mom ->
      case father mom of
        Nothing -> Nothing
        Just gf2 ->      -- found second
grandfather
    Just (gf1, gf2)

```

What a mouthful! Every single query might fail by returning `Nothing` and the whole function must fail with `Nothing` if that happens.

Clearly there has to be a better way to write that instead of repeating the case of `Nothing` again and again! Indeed, that's what the `Maybe` monad is set out to do. For instance, the function retrieving the maternal grandfather has exactly the same structure as the `(>>=)` operator, so we can rewrite it as:

```
maternalGrandfather p = mother p >>= father
```

With the help of lambda expressions and `return`, we can rewrite the two grandfathers function as well:

```

bothGrandfathers p =
  father p >>=
    (\dad -> father dad >>=
      (\gf1 -> mother p >>= -- gf1 is only used in the final return
        (\mom -> father mom >>=
          (\gf2 -> return (gf1,gf2) ))))

```

While these nested lambda expressions may look confusing to you, the thing to take away here is that `(>>=)` releases us from listing all the `Nothings`, shifting the focus back to the interesting part of the code.

To be a little more precise: The result of `father p` is a monadic value (in this case, either `Just dad` or `Nothing`, depending on whether `p`'s father is in the database). As the `father` function takes a regular (non-monadic value), the `(>>=)` feeds `p`'s `dad` to it *as a non-monadic* value. The result of `father dad` is then monadic again, and the process continues.

So, `(>>=)` helps us pass non-monadic values to functions without actually leaving a monad. In the case of the `Maybe` monad, the monadic aspect is the qualifier that we don't know with certainty whether the value will be found.

30.1.2 Type class

In Haskell, the `Monad` type class is used to implement monads. It is provided by the `Control.Monad`⁷ module and included in the Prelude. The class has the following methods:

```

class Applicative m => Monad m where
  return :: a -> m a
  (>>=)  :: m a -> (a -> m b) -> m b

  (>>)   :: m a -> m b -> m b
  fail   :: String -> m a

```

⁷ <http://hackage.haskell.org/packages/archive/base/latest/doc/html/Control-Monad.html>

Aside from `return` and `bind`, there are two additional methods, `(>>)` and `fail`. Both of them have default implementations, and so you don't need to provide them when writing an instance.

The operator `(>>)`, spelled "then", is a mere convenience and has the default implementation

```
m >> n = m >>= \_ -> n
```

`(>>)` sequences two monadic actions when the second action does not involve the result of the first, which is a common scenario for monads such as `IO`.

```
printSomethingTwice :: String -> IO ()
printSomethingTwice str = putStrLn str >> putStrLn str
```

The function `fail` handles pattern match failures in `do` notation⁸. It's an unfortunate technical necessity and doesn't really have anything to do with monads. You are advised not to call `fail` directly in your code.

30.1.3 Monad and Applicative

An important thing to note is that `Applicative` is a superclass of `Monad`.⁹ That has a few consequences worth highlighting. First of all, every `Monad` is also a `Functor` and an `Applicative`, and so `fmap`, `pure`, `(<*>)` can all be used with monads. Secondly, actually writing a `Monad` instance also requires providing `Functor` and `Applicative` instances. We will discuss ways of doing that later in this chapter. Thirdly, if you have worked through the Prologue¹⁰, the types and roles of `return` and `(>>)` should look familiar...

```
(<*>) :: Applicative f => f a -> f b -> f b
(>>)  :: Monad m => m a -> m b -> m b
```

```
pure  :: Applicative f => a -> f a
return :: Monad m => a -> m a
```

The only difference between the types of `(<*>)` and `(>>)` is that the constraint changes from `Applicative` to `Monad`. In fact, that is the only difference between the methods: if you are dealing with a `Monad` you can always replace `(<*>)` and `(>>)`, and vice-versa. The same goes for `pure/return` – in fact, it is not even necessary to implement `return` if there is an independent definition of `pure` in the `Applicative` instance, as `return = pure` is provided as a default definition of `return`.

30.2 Notions of Computation

We have seen how `(>>=)` and `return` are very handy for removing boilerplate code that crops up when using `Maybe`. That, however, is not enough to justify why monads matter so much. Our next step towards that will be rewriting the two-grandfathers function in a quite

8 Chapter 33 on page 207

9 This important superclass relationship was, thanks to historic accidents, only implemented quite recently (early 2015) in GHC (version 7.10). If you are using a GHC version older than that, this class constraint will not exist, and so some of the practical considerations we will make next will not apply.

10 <https://en.wikibooks.org/wiki/Haskell%2FApplicative%20prologue>

different-looking style: using `do` notation with explicit braces and semicolons¹¹. Depending on your experience with other programming languages, you may find this very suggestive:

```
bothGrandfathers p = do {
  dad <- father p;
  gf1 <- father dad;
  mom <- mother p;
  gf2 <- father mom;
  return (gf1, gf2);
}
```

If this looks like a code snippet in an imperative programming language to you, that's because it *is*. In particular, this imperative language supports *exceptions*: `father` and `mother` are functions that might fail to produce results, raising an exception instead; and when that happens, the whole `do`-block will *fail*, i.e. terminate with an exception (meaning, evaluate to `Nothing`, here).

In other words, the expression `father p`, which has type `Maybe Person`, is interpreted as a statement in an imperative *language* that returns a `Person` as the result, or fails.

This is true for all monads: a value of type `M a` is interpreted as a *statement* in an imperative language `M` that returns a value of type `a` as its result; and the semantics of this language are determined by the monad `M`.¹²

Under this interpretation, the *then* operator (`>>`) is simply an implementation of the semicolon, and (`>>=`) – of the semicolon and assignment (binding) of the result of a previous computational step. Just like a `let` expression can be written as a function application,

<pre>let x = foo in (x + 3) -- v & f = f v</pre>	corresponds to	<pre>foo & (\x -> id (x + 3))</pre>
--	----------------	--

an assignment and semicolon can be written with the bind operator:

<pre>x <- foo; return (x + 3) 3))</pre>	corresponds to	<pre>foo >>= (\x -> return (x +</pre>
--	----------------	--

In case of functions, `&` and `id` are trivial; in case of a monad, `>>=` and `return` are substantial.

The `&` operator combines together two pure *calculations*, `foo` and `id (x + 3)`, while creating a new binding for the variable `x` to hold `foo`'s *value*, making `x` available to the second calculational step, `id (x + 3)`.

The bind operator `>>=` combines together two *computational* steps, `foo` and `return (x + 3)`, in a manner particular to the monad `M`, while creating a new binding for the variable `x` to hold `foo`'s *result*, making `x` available to the next computational step, `return (x +`

¹¹ Chapter 23.2 on page 144

¹² By "semantics" we mean *what* the language allows you to say. In the case of `Maybe`, the semantics allow us to express failure, as statements may fail to produce a result, leading to the statements that follow it being skipped.

3). In the particular case of `Maybe`, if `foo` will fail to produce a result, the second step is skipped and the whole combined computation will fail right away as well.

The function `return` lifts a plain value `a` to `M a`, a statement in the imperative language `M`, which statement, when executed / run, will result in the value `a` without any additional effects particular to `M`. This is ensured by Monad Laws, `foo >>= return === foo` and `return x >>= k === k x`; see below.

Note:

The fact that (`>>=`), and therefore `Monad`, lies behind the left arrows in `do`-blocks explains why we were not able to explain them in the Prologue^a, when we only knew about `Functor` and `Applicative`. `Applicative` would be enough to provide some, but not all, of the functionality of a `do`-block.

^a <https://en.wikibooks.org/wiki/Haskell%2FApplicative%20prologue%23The%20end%20of%20the%20beginning>

Different semantics of the imperative language correspond to different monads. The following table shows the classic selection that every Haskell programmer should know. If the idea behind monads is still unclear to you, studying each of the examples in the following chapters will not only give you a well-rounded toolbox but also help you understand the common abstraction behind them.

Monad	Imperative Semantics	Wikibook chapter
<code>Maybe</code>	Exception (anonymous)	Haskell/Understanding monads/Maybe ¹³
<code>Error</code>	Exception (with error description)	Haskell/Understanding monads/Error ¹⁴
<code>State</code>	Global state	Haskell/Understanding monads/State ¹⁵
<code>IO</code>	Input/Output	Haskell/Understanding monads/IO ¹⁶
<code>[]</code> (lists)	Nondeterminism	Haskell/Understanding monads/List ¹⁷
<code>Reader</code>	Environment	Haskell/Understanding monads/Reader ¹⁸
<code>Writer</code>	Logger	Haskell/Understanding monads/Writer ¹⁹

Furthermore, these different semantics need not occur in isolation. As we will see in a few chapters, it is possible to mix and match them by using monad transformers²⁰ to combine the semantics of multiple monads in a single monad.

13 Chapter 31 on page 199

14 <https://en.wikibooks.org/wiki/Haskell%2FUnderstanding%20monads%2FError>

15 Chapter 35 on page 219

16 Chapter 34 on page 213

17 Chapter 32 on page 203

18 <https://en.wikibooks.org/wiki/Haskell%2FUnderstanding%20monads%2FReader>

19 <https://en.wikibooks.org/wiki/Haskell%2FUnderstanding%20monads%2FWriter>

20 Chapter 37 on page 241

30.3 Monad Laws

In Haskell, every instance of the `Monad` type class (and thus all implementations of `bind` (`>>=`) and `return`) must obey the following three laws:

```
m >>= return    = m                -- right unit
return x >>= f   = f x              -- left unit

(m >>= f) >>= g  = m >>= (\x -> f x >>= g) -- associativity
```

30.3.1 Return as neutral element

The behavior of `return` is specified by the left and right unit laws. They state that `return` doesn't perform any computation, it just collects values. For instance,

```
maternalGrandfather p = do
  mom <- mother p
  gf  <- father mom
  return gf
```

is exactly the same as

```
maternalGrandfather p = do
  mom <- mother p
  father mom
```

by virtue of the right unit law.

30.3.2 Associativity of bind

The law of associativity makes sure that (like the semicolon) the bind operator (`>>=`) only cares about the order of computations, not about their nesting; e.g. we could have written `bothGrandfathers` like this (compare with our earliest version without `do`):

```
bothGrandfathers p =
  (father p >>= father) >>=
    (\gf1 -> (mother p >>= father) >>=
      (\gf2 -> return (gf1,gf2) ))
```

The associativity of the *then* operator (`>>`) is a special case:

```
(m >> n) >> o = m >> (n >> o)
```

Monadic composition

It is easier to picture the associativity of bind by recasting the law as

```
(f >=> g) >=> h = f >=> (g >=> h)
```

where (`>=>`) is the *monad composition operator*, a close analogue of the function composition operator (`.`), only with flipped arguments. It is defined as:

```
(>=>) :: Monad m => (a -> m b) -> (b -> m c) -> a -> m c
f >=> g = \x -> f x >>= g
```

There is also ($\leq\leq$), which is flipped version of ($\geq\geq$). When using it, the order of composition matches that of (\cdot), so that in ($f \leq\leq g$) g comes first.²¹

30.4 Monads and Category Theory

Monads originally come from a branch of mathematics called Category Theory. Fortunately, it is entirely unnecessary to understand category theory in order to understand and use monads in Haskell. The definition of monads in Category Theory actually uses a slightly different presentation. Translated into Haskell, this presentation gives an alternative yet equivalent definition of a monad which can give us some additional insight.²²

So far, we have defined monads in terms of ($\geq\geq$) and `return`. The alternative definition, instead, treats monads as functors with two additional combinators:

```
fmap  :: (a -> b) -> M a -> M b  -- functor
return :: a -> M a
join   :: M (M a) -> M a
```

For the purposes of this discussion, we will use the functors-as-containers metaphor discussed in the chapter on the functor class²³. According to it, a functor M can be thought of as container, so that $M\ a$ "contains" values of type a , with a corresponding mapping function, i.e. `fmap`, that allows functions to be applied to values inside it.

Under this interpretation, the functions behave as follows:

- `fmap` applies a given function to every element in a container
- `return` packages an element into a container,
- `join` takes a container of containers and flattens it into a single container.

With these functions, the bind combinator can be defined as follows:

```
m >>= g = join (fmap g m)
```

Likewise, we could give a definition of `fmap` and `join` in terms of ($\geq\geq$) and `return`:

```
fmap f x = x >>= (return . f)
join x   = x >>= id
```

30.5 liftM and Friends

Earlier, we pointed out that every `Monad` is an `Applicative`, and therefore also a `Functor`. One of the consequences of that was `return` and ($\geq\geq$) being monad-only versions of `pure` and ($\ast\ast$) respectively. It doesn't stop there, though. For one, `Control.Monad` defines `liftM`, a function with a strangely familiar type signature...

21 Of course, the functions in regular function composition are non-monadic functions whereas monadic composition takes only monadic functions.

22 Deep into the Advanced Track, we will cover the theoretical side of the story in the chapter on Category Theory ^{Chapter59.3 on page 451}.

23 Chapter 27 on page 173

```
liftM :: (Monad m) => (a1 -> r) -> m a1 -> m r
```

As you might suspect, `liftM` is merely `fmap` implemented with `(>>=)` and `return`, just as we have done in the previous section. `liftM` and `fmap` are therefore interchangeable.

Another `Control.Monad` function with an uncanny type is `ap`:

```
ap :: Monad m => m (a -> b) -> m a -> m b
```

Analogously to the other cases, `ap` is a monad-only version of `(<*>)`.

There are quite a few more examples of `Applicative` functions that have versions *specialised* to `Monad` in `Control.Monad` and other base library modules. Their existence is primarily due to historical reasons: several years went by between the introductions of `Monad` and `Applicative` in Haskell, and it took an even longer time for `Applicative` to become a superclass of `Monad`, thus making usage of the specialised variants optional. While in principle there is little need for using the monad-only versions nowadays, in practice you will see `return` and `(>>)` all the time in other people's code – at this point, their usage is well established thanks to more than two decades of Haskell praxis without `Applicative` being a superclass of `Monad`.

Note:

Given that `Applicative` is a superclass of `Monad`, the most obvious way of implementing `Monad` begins by writing the `Functor` instance and then moving down the class hierarchy:

```
instance Functor Foo where
    fmap = -- etc.

instance Applicative Foo where
    pure = -- etc.
    (<*>) = -- etc.

instance Monad Foo where
    (>>=) = -- etc.
```

While following the next few chapters, you will likely want to write instances of `Monad` and try them out, be it to run the examples in the book or to do other experiments you might think of. However, writing the instances in the manner shown above requires implementing `pure` and `(<*>)`, which is not a comfortable task at this point of the book as we haven't covered the `Applicative` laws yet (we will only do so at the applicative functors chapter^a). Fortunately, there is a workaround: implementing just `(>>=)` and `return`, thus providing a self-sufficient `Monad` instance, and then using `liftM`, `ap` and `return` to fill in the other instances:

```
instance Monad Foo where
    return = -- etc.
    (>>=) = -- etc.

instance Applicative Foo where
    pure = return
    (<*>) = ap

instance Functor Foo where
    fmap = liftM
```

The examples and exercises in this initial series of chapters about monads will not demand writing `Applicative` instances, and so you can use this workaround until we discuss `Applicative` in detail.

^a Chapter 40 on page 261

31 The Maybe monad

We introduced monads using `Maybe` as an example. The `Maybe` monad represents computations which might "go wrong" by not returning a value. For reference, here are the definitions of `return` and `(>>=)` for `Maybe` as we saw in the last chapter:¹

```
return :: a -> Maybe a
return x = Just x

(>>=) :: Maybe a -> (a -> Maybe b) -> Maybe b
(>>=) m g = case m of
  Nothing -> Nothing
  Just x  -> g x
```

31.1 Safe functions

The `Maybe` datatype provides a way to make a safety wrapper around *partial functions*, that is, functions which can fail to work for a range of arguments. For example, `head` and `tail` only work with non-empty lists. Another typical case, which we will explore in this section, are mathematical functions like `sqrt` and `log`; (as far as real numbers are concerned) these are only defined for non-negative arguments.

```
> log 1000
6.907755278982137
> log (-1000)
''ERROR'' -- runtime error
```

To avoid this crash, a "safe" implementation of `log` could be:

```
safeLog :: (Floating a, Ord a) => a -> Maybe a
safeLog x
  | x > 0    = Just (log x)
  | otherwise = Nothing
```

```
> safeLog 1000
Just 6.907755278982137
> safeLog -1000
Nothing
```

We could write similar "safe functions" for all functions with limited domains such as division, square-root, and inverse trigonometric functions (`safeDiv`, `safeSqrt`, `safeArcSin`, etc. all of which would have the same *type* as `safeLog` but definitions specific to their constraints)

¹ The definitions in the actual instance in `Data.Maybe` are written a little differently, but are fully equivalent to these.

If we wanted to combine these monadic functions, the cleanest approach is with monadic composition (which was mentioned briefly near the end of the last chapter²) and point-free style:

```
safeLogSqrt = safeLog <=< safeSqrt
```

Written in this way, `safeLogSqrt` resembles a lot its unsafe, non-monadic counterpart:

```
unsafeLogSqrt = log . sqrt
```

31.2 Lookup tables

A lookup table relates *keys* to *values*. You *look up* a value by knowing its key and using the lookup table. For example, you might have a phone book application with a lookup table where contact names are keys to corresponding phone numbers. An elementary way of implementing lookup tables in Haskell is to use a list of pairs: `[(a, b)]`. Here `a` is the type of the keys, and `b` the type of the values.³ Here's how the phone book lookup table might look:

```
phonebook :: [(String, String)]
phonebook = [ ("Bob", "01788 665242"),
              ("Fred", "01624 556442"),
              ("Alice", "01889 985333"),
              ("Jane", "01732 187565") ]
```

The most common thing you might do with a lookup table is look up values. Everything is fine if we try to look up "Bob", "Fred", "Alice" or "Jane" in our phone book, but what if we were to look up "Zoe"? Zoe isn't in our phone book, so the lookup would fail. Hence, the Haskell function to look up a value from the table is a `Maybe` computation (it is available from Prelude):

```
lookup :: Eq a => a -- a key
        -> [(a, b)] -- the lookup table to use
        -> Maybe b -- the result of the lookup
```

Let us explore some of the results from lookup:

```
Prelude> lookup "Bob" phonebook
Just "01788 665242"
Prelude> lookup "Jane" phonebook
Just "01732 187565"
Prelude> lookup "Zoe" phonebook
Nothing
```

Now let's expand this into using the full power of the monadic interface. Say, we're now working for the government, and once we have a phone number from our contact, we want to look up this phone number in a big, government-sized lookup table to find out the

² Chapter 30.3.2 on page 195

³ Check the chapter about `maps` ^{[^](https://en.wikibooks.org/wiki/Haskell%2FHierarchical%20libraries%2FMaps)}<https://en.wikibooks.org/wiki/Haskell%2FHierarchical%20libraries%2FMaps> in Haskell in Practice for a different, and potentially more useful, implementation.

registration number of their car. This, of course, will be another `Maybe`-computation. But if the person we're looking for isn't in our phone book, we certainly won't be able to look up their registration number in the governmental database. What we need is a function that will take the results from the first computation and put it into the second lookup *only* if we get a successful value in the first lookup. Of course, our final result should be `Nothing` if we get `Nothing` from either of the lookups.

```
getRegistrationNumber :: String      -- their name
                    -> Maybe String -- their registration number
getRegistrationNumber name =
  lookup name phonebook >>=
    (\number -> lookup number governmentDatabase)
```

If we then wanted to use the result from the governmental database lookup in a third lookup (say we want to look up their registration number to see if they owe any car tax), then we could extend our `getRegistrationNumber` function:

```
getTaxOwed :: String      -- their name
           -> Maybe Double -- the amount of tax they owe
getTaxOwed name =
  lookup name phonebook >>=
    (\number -> lookup number governmentDatabase) >>=
      (\registration -> lookup registration taxDatabase)
```

Or, using the `do`-block style:

```
getTaxOwed name = do
  number      <- lookup name phonebook
  registration <- lookup number governmentDatabase
  lookup registration taxDatabase
```

Let's just pause here and think about what would happen if we got a `Nothing` anywhere. By definition, when the first argument to `>>=` is `Nothing`, it just returns `Nothing` while ignoring whatever function it is given. Thus, a `Nothing` at *any stage* in the large computation will result in a `Nothing` overall, regardless of the other functions. After the first `Nothing` hits, all `>>=`s will just pass it to each other, skipping the other function arguments. The technical description says that the structure of the `Maybe` monad *propagates failures*.

31.3 Extracting values

If we have a `Just` value, we can extract the underlying value it contains through pattern matching.

```
zeroAsDefault :: Maybe Int -> Int
zeroAsDefault mx = case mx of
  Nothing -> 0
  Just x  -> x
```

The usage pattern of replacing `Nothing` with a default value is captured by the `fromMaybe` function in `Data.Maybe`.

```
zeroAsDefault :: Maybe Int -> Int
zeroAsDefault mx = fromMaybe 0 mx
```

The `maybe` Prelude function allows us to do it in a more general way, by supplying a function to modify the extracted value.

```
displayResult :: Maybe Int -> String
displayResult mx = maybe "There was no result" (("The result was " ++) . show)
  mx
```

```
Prelude> :t maybe
maybe :: b -> (a -> b) -> Maybe a -> b
Prelude> displayResult (Just 10)
"The result was 10"
Prelude> displayResult Nothing
"There was no result"
```

The possibility of, whenever possible, extracting the underlying values makes sense for `Maybe`: it amounts to either extracting a result from a successful computation or recovering from a failed computation by supplying a default. It is worth noting, though, that what we have just seen doesn't actually involve the fact of `Maybe` being a monad. `return` and `(>>=)`, on their own, do not enable us to extract the underlying value from a monadic computation, and so it is perfectly possible to make a "no-exit" monad, from which it is never possible to extract values. The most obvious example of that is the `IO` monad.

31.4 Maybe and safety

We have seen how `Maybe` can make code safer by providing a graceful way to deal with failure that does not involve runtime errors. Does that mean we should always use `Maybe` for *everything*? Not really.

When you write a function, you are able to tell whether it might fail to produce a result during normal operation of the program,⁴ either because the functions you use might fail (as in the examples in this chapter) or because you know some of the argument or intermediate result values do not make sense (for instance, imagine a calculation that is only meaningful if its argument is less than 10). If that is the case, by all means use `Maybe` to signal failure; it is far better than returning an arbitrary default value or throwing an error.

Now, adding `Maybe` to a result type without a reason would only make the code more confusing and no safer. The type signature of a function with unnecessary `Maybe` would tell users of the code that the function could fail when it actually can't. Of course, that is not as bad a lie as the opposite one (that is, claiming that a function will not fail when it actually can), but we really want honest code in *all* cases. Furthermore, using `Maybe` forces us to propagate failure (with `fmap` or monadic code) and eventually handle the failure cases (using pattern matching, the `maybe` function, or `fromMaybe` from `Data.Maybe`). If the function cannot actually fail, coding for failure is an unnecessary complication.

⁴ With "normal operation" we mean to exclude failure caused by uncontrollable circumstances in the real world, such as memory exhaustion or a dog chewing the printer cable.

32 The List monad

Lists are a fundamental part of Haskell, and we've used them extensively before getting to this chapter. The novel insight is that the list type is a monad too!

As monads, lists are used to model *nondeterministic* computations which may return an arbitrary number of results. There is a certain parallel with how `Maybe` represented computations which could return zero or one value; but with lists, we can return zero, one, or many values (the number of values being reflected in the length of the list).

32.1 The Monad instance of lists

The `return` function for lists simply injects a value into a list:

```
return x = [x]
```

In other words, `return` here makes a list containing one element, namely the single argument it took. The type of the *list return* is `return :: a -> [a]`, or, equivalently, `return :: a -> [] a`. The latter style of writing it makes it more obvious that we are replacing the generic type constructor in the signature of `return` (which we had called `M` in *Understanding monads*¹) by the list type constructor `[]` (which is distinct from but easy to confuse with the empty list!).

The binding operator is less trivial. We will begin by considering its type, which for the case of lists should be:

```
[a] -> (a -> [b]) -> [b]
```

This is just what we'd expect: it pulls out the values from the list to give them to a function that produces a new list.

The actual process here involves first *mapping* a given function over a given list to get back a list of lists, i.e. type `[[b]]` (of course, many functions which you might use in mapping do not return lists; but, as shown in the type signature above, monadic binding for lists only works with functions that return lists). To get back to a regular list, we then concatenate the elements of our list of lists to get a final result of type `[b]`. Thus, we can define the list version of `(>>=)`:

```
xs >>= f = concat (map f xs)
```

The bind operator is key to understanding how different monads do their jobs, as its definition specifies the chaining strategy used when working with the monad. In the case of

¹ Chapter 30 on page 189

the list monad, the strategy allows us to model non-determinism: an `a -> [b]` function can be seen as a way of generating, from an input of type `a`, an unspecified number of *possible* outputs of type `b`, without settling on any one of them in particular. (`>>=`), from that perspective, does that for multiple inputs and combines all output possibilities in a single result list.

32.2 Bunny invasion

It is easy to incorporate the familiar list processing functions in monadic code. Consider this example: rabbits raise an average of six kits in each litter, half of which will be female. Starting with a single mother, we can model the number of female kits in each successive generation (i.e. the number of new kits after the rabbits grow up and have their own litters):

```
Prelude> let generation = replicate 3
Prelude> ["bunny"] >>= generation
["bunny","bunny","bunny"]
Prelude> ["bunny"] >>= generation >>= generation
["bunny","bunny","bunny","bunny","bunny","bunny","bunny","bunny","bunny"]
```

In this silly example all elements are equal, but the same overall logic could be used to model radioactive decay², or chemical reactions, or any phenomena that produces a series of elements starting from a single one.

Exercises:

1. Predict what should be the result of `["bunny", "rabbit"] >>= generation`.
2. Implement `themselvesTimes :: [Int] -> [Int]`, which takes each number `n` in the argument list and generates `n` copies of it in the result list.

32.3 Board game example

Suppose we are modeling a turn-based board game and want to find all the possible ways the game could progress. We would need a function to calculate the list of options for the next turn, given a current board state:

```
nextConfigs :: Board -> [Board]
nextConfigs bd = undefined -- details not important
```

To figure out all the possibilities after two turns, we would again apply our function to each of the elements of our new list of board states. Our function takes a single board state and returns a list of possible new states. Thus, we can use monadic binding to map the function over each element from the list:

```
nextConfigs bd >>= nextConfigs
```

² http://en.wikipedia.org/wiki/Decay_chain

In the same fashion, we could bind the result back to the function yet again (ad infinitum) to generate the next turn's possibilities. Depending on the particular game's rules, we may reach board states that have no possible next-turns; in those cases, our function will return the empty list.

On a side note, we could translate several turns into a `do` block (like we did for the grandparents example in Understanding monads³):

```
threeTurns :: Board -> [Board]
threeTurns bd = do
  bd1 <- nextConfigs bd -- bd1 refers to a board configuration after 1 turn
  bd2 <- nextConfigs bd1
  nextConfigs bd2
```

If the above looks too magical, keep in mind that `do` notation is syntactic sugar for (`>>=`) operations. To the right of each left-arrow, there is a function with arguments that evaluate to a list; the variable to the left of the arrow stands for the list elements. After a left-arrow assignment line, there can be later lines that call the assigned variable as an argument for a function. This later function will be performed for *each* of the elements from within the list that came from the left-arrow line's function. This per-element process corresponds to the 'map' in the definition of (`>>=`). A resulting list of lists (one per element of the original list) will be flattened into a single list (the 'concat' in the definition of (`>>=`)).

32.4 List comprehensions

The list monad works in a way that has uncanny similarity to list comprehensions. Let's slightly modify the `do` block we just wrote for `threeTurns` so that it ends with a `return...`

```
threeTurns bd = do
  bd1 <- nextConfigs bd
  bd2 <- nextConfigs bd1
  bd3 <- nextConfigs bd2
  return bd3
```

This mirrors exactly the following list comprehension:

```
threeTurns bd = [ bd3 | bd1 <- nextConfigs bd, bd2 <- nextConfigs bd1, bd3 <-
  nextConfigs bd2 ]
```

(In a list comprehension, it is perfectly legal to use the elements drawn from one list to define the following ones, like we did here.)

The resemblance is no coincidence: list comprehensions are, behind the scenes, defined in terms of `concatMap`, a function available from the Prelude that is defined as `concatMap f xs = concat (map f xs)`. That's just the list monad binding definition again! To summarize the nature of the list monad: binding for the list monad *is* a combination of concatenation and mapping, and so the combined function `concatMap` *is* effectively the same as `>>=` for lists (except for different syntactic order).

3 Chapter 30 on page 189

For the correspondence between list monad and list comprehension to be complete, we need a way to reproduce the filtering that list comprehensions can do. We will explain how that can be achieved a little later in the Additive monads⁴ chapter.

Exercises:

As discussed in Understanding monads^a, all `Monads` also have an instance of `Applicative`. In particular, `(<*>)` for that instance might be defined as:

```
fs <*> xs = concatMap (\f -> map f xs) fs
```

1. Explain briefly what this `(<*>)` does.
2. Write an alternative definition of `(<*>)` using a list comprehension. Do not use `map`, `concat` or `concatMap` explicitly.

^a Chapter 30 on page 189

⁴ <https://en.wikibooks.org/wiki/Haskell%2FMonadPlus>

33 do Notation

Using `do` blocks as an alternative monad syntax was first introduced way back in the Simple input and output¹ chapter. There, we used `do` to sequence input/output operations, but we hadn't introduced monads yet. Now, we can see that `IO` is yet another monad.

Since the following examples all involve `IO`, we will refer to the computations/monadic values as *actions* (as we did in the earlier parts of the book). Of course, `do` works with any monad; there is nothing specific about `IO` in how it works.

33.1 Translating the *then* operator

The `(>>)` (*then*) operator works almost identically in `do` notation and in unsugared code. For example, suppose we have a chain of actions like the following one:

```
putStr "Hello" >>
putStr " " >>
putStr "world!" >>
putStr "\n"
```

We can rewrite that in `do` notation as follows:

```
do { putStr "Hello"
    ; putStr " "
    ; putStr "world!"
    ; putStr "\n" }
```

(using the optional braces and semicolons explicitly, for clarity). This sequence of instructions nearly matches that in any imperative language. In Haskell, we can chain any actions as long as all of them are in the same monad. In the context of the `IO` monad, the actions include writing to a file, opening a network connection, or asking the user for an input.

Here's the step-by-step translation of `do` notation to unsugared Haskell code:

```
do { action1          -- by monad laws equivalent to: do { action1
    ; action2          --                               ; do { action2
    ; action3 }        --                               ; action3 } }
```

becomes

```
action1 >>
do { action2
    ; action3 }
```

and so on, until the `do` block is empty.

¹ Chapter 10 on page 67

33.2 Translating the *bind* operator

The *bind* operator (`>>=`) is a bit more difficult to translate from and to the `do` notation. (`>>=`) passes a value, namely the result of an action or function, downstream in the binding sequence. `do` notation assigns a variable name to the passed value using the `<-`.

```
do { x1 <- action1
    ; x2 <- action2
    ; mk_action3 x1 x2 }
```

The curly braces and the semicolons are optional if every line of code is indented to line up equally (NB: beware the mixing of tabs and spaces in that case; with the explicit curly braces and semicolons indentation plays no part and there's no danger).

`x1` and `x2` are the results of `action1` and `action2`. If, for instance, `action1` is an `I0 Integer` then `x1` will be bound to an `Integer` value. The two bound values in this example are passed as arguments to `mk_action3`, which creates a third action. The `do` block is broadly equivalent to the following vanilla Haskell snippet:

```
action1 >>= (\ x1 -> action2 >>= (\ x2 -> mk_action3 x1 x2 ))
```

The second argument of the first (leftmost) bind operator (`>>=`) is a function (lambda expression) specifying what to do with the result of the action passed as the bind's first argument. Thus, chains of lambdas pass the results downstream. The parentheses could be omitted, because a lambda expression extends as far as possible. `x1` is still in scope at the point we call the final action maker `mk_action3`. We can rewrite the chain of lambdas more legibly by using separate lines and indentation:

```
action1
  >>=
    (\ x1 -> action2
      >>=
        (\ x2 -> mk_action3 x1 x2 ))
```

That shows the scope of each lambda function clearly. To group things more like the `do` notation, we could show it like this:

```
action1 >>= (\ x1 ->
  action2 >>= (\ x2 ->
    mk_action3 x1 x2 ))
```

These presentation differences are only a matter of assisting readability.²

² Actually, the indentation isn't needed in this case. This is equally valid:

```
action1 >>= \ x1 ->
action2 >>= \ x2 ->
action3 x1 x2
```

Of course, we could use even more indentation if we wanted. Here's an extreme example:

33.2.1 The *fail* method

Above, we said the snippet with lambdas was "broadly equivalent" to the `do` block. The translation is not exact because the `do` notation adds special handling of pattern match failures. When placed at the left of either `<-` or `->`, `x1` and `x2` are patterns being matched. Therefore, if `action1` returned a `Maybe Integer` we could write a `do` block like this...

```
do { Just x1 <- action1
    ; x2      <- action2
    ; mk_action3 x1 x2 }
```

...and `x1` be an `Integer`. In such a case, what happens if `action1` returns `Nothing`? Ordinarily, the program would crash with a non-exhaustive patterns error, just like the one we get when calling `head` on an empty list. With `do` notation, however, failures are handled with the `fail` method for the relevant monad. The `do` block above translates to:

```
action1 >>= f
where f (Just x1) = do { x2 <- action2
                       ; mk_action3 x1 x2 }
      f _         = fail "... " -- A compiler-generated message.
```

What `fail` actually does depends on the monad instance. Though it will often rethrow the pattern matching error, monads that incorporate some sort of error handling may deal with the failure in their own specific ways. For instance, `Maybe` has `fail _ = Nothing`; analogously, for the list monad `fail _ = []`.³

```

action1
  >>= \
    x1
      ->
        action2
          >>= \
            x2
              ->
                action3
                  x1
                  x2
```

While that indentation is certainly overkill, it could be worse:

```

action1
  >>= \
    x1
      -> action2 >>=
          \
            x2 ->
                action3 x1
                x2
```

That is valid Haskell but is baffling to read; so please don't ever write like that. Write your code with consistent and meaningful groupings.

- This explains why, as we pointed out in the "Pattern matching" chapter ^{Chapter16.5.3 on page 114}, pattern matching failures in list comprehensions are silently ignored.

The `fail` method is an artifact of `do` notation. Rather than calling `fail` directly, you should rely on automatic handling of pattern match failures whenever you are sure that `fail` will do something sensible for the monad you are using.

33.3 Example: user-interactive program

Note:

We are going to interact with the user, so we will use `putStr` and `getLine` alternately. To avoid unexpected results in the output, we must disable output buffering when importing `System.IO`. To do this, put `hSetBuffering stdout NoBuffering` at the top of your code. To handle this otherwise, you would explicitly flush the output buffer before each interaction with the user (namely a `getLine`) using `hFlush stdout`. If you are testing this code with `ghci`, you don't have such problems.

Consider this simple program that asks the user for their first and last names:

```
nameDo :: IO ()
nameDo = do putStr "What is your first name? "
           first <- getLine
           putStr "And your last name? "
           last <- getLine
           let full = first ++ " " ++ last
           putStrLn ("Pleased to meet you, " ++ full ++ "!")
```

A possible translation into vanilla monadic code:

```
nameLambda :: IO ()
nameLambda = putStr "What is your first name? " >>
            getLine >>= \ first ->
            putStr "And your last name? " >>
            getLine >>= \ last ->
            let full = first ++ " " ++ last
            in putStrLn ("Pleased to meet you, " ++ full ++ "!")
```

In cases like this, where we just want to chain several actions, the imperative style of `do` notation feels natural and convenient. In comparison, monadic code with explicit binds and lambdas is something of an acquired taste.

Notice that the first example above includes a `let` statement in the `do` block. The desugared version is simply a regular `let` expression where the `in` part is whatever follows from the `do` syntax.

33.4 Returning values

The last statement in `do` notation is the overall result of the `do` block. In the previous example, the result was of the type `IO ()`, i.e. an empty value in the `IO` monad.

Suppose that we want to rewrite the example but return an `IO String` with the acquired name. All we need to do is add a `return`:

```
nameReturn :: IO String
nameReturn = do putStr "What is your first name? "
```

```

first <- getLine
putStr "And your last name? "
last <- getLine
let full = first ++ " " ++ last
putStrLn ("Pleased to meet you, " ++ full ++ "!")
return full

```

This example will "return" the full name as a string inside the IO monad, which can then be utilized downstream elsewhere:

```

greetAndSeeYou :: IO ()
greetAndSeeYou = do name <- nameReturn
                  putStrLn ("See you, " ++ name ++ "!")

```

Here, `nameReturn` will be run and the returned result (called "full" in the `nameReturn` function) will be assigned to the variable "name" in our new function. The greeting part of `nameReturn` will be printed to the screen because that is part of the calculation process. Then, the additional "see you" message will print as well, and the final returned value is back to being `IO ()`.

If you know imperative languages like C, you might think `return` in Haskell matches `return` elsewhere. A small variation on the example will dispel that impression:

```

nameReturnAndCarryOn = do putStrLn "What is your first name? "
                          first <- getLine
                          putStrLn "And your last name? "
                          last <- getLine
                          let full = first++" "++last
                          putStrLn ("Pleased to meet you, "++full++"!")
                          return full
                          putStrLn "I am not finished yet!"

```

The string in the extra line *will* be printed out because `return` is *not* a final statement interrupting the flow (as it would be in C and other languages). Indeed, the type of `nameReturnAndCarryOn` is `IO ()`, — the type of the final `putStrLn` action. After the function is called, the `IO String` created by the `return full` will disappear without a trace.

33.5 Just sugar

As a syntactical convenience, `do` notation does not add anything essential, but it is often preferable for clarity and style. However, `do` is not needed for a single action, at all. The Haskell "Hello world" is simply:

```
main = putStrLn "Hello world!"
```

Snippets like this one are totally redundant:

```
fooRedundant = do { x <- bar
                  ; return x }
```

Thanks to the monad laws⁴, we can write it simply as

⁴ https://en.wikibooks.org/wiki/Haskell%2FMonads%23Monad_Laws

```
foo = do { bar } -- which is, further,  
foo = bar
```

A subtle but crucial point relates to function composition: As we already know, the `greetAndSeeYou` action in the section just above could be rewritten as:

```
greetAndSeeYou :: IO ()  
greetAndSeeYou = nameReturn >>= (\ name -> putStrLn ("See you, " ++ name ++  
"!"))
```

While you might find the lambda a little unsightly, suppose we had a `printSeeYou` function defined elsewhere:

```
printSeeYou :: String -> IO ()  
printSeeYou name = putStrLn ("See you, " ++ name ++ "!")
```

Now, we can have a clean function definition with neither lambdas or `do`:

```
greetAndSeeYou :: IO ()  
greetAndSeeYou = nameReturn >>= printSeeYou
```

Or, if we have a *non-monadic* `seeYou` function:

```
seeYou :: String -> String  
seeYou name = "See you, " ++ name ++ "!"
```

Then we can write:

```
-- Reminder: fmap f m == m >>= (return . f) == liftM f m  
greetAndSeeYou :: IO ()  
greetAndSeeYou = fmap seeYou nameReturn >>= putStrLn
```

Keep this last example with `fmap` in mind; we will soon return to using non-monadic functions in monadic code, and `fmap` will be useful there.

34 The IO monad

Two defining features of Haskell are *pure functions* and *lazy evaluation*. All Haskell functions are pure, which means that, when given the same arguments, they return the same results. Lazy evaluation means that, by default, Haskell values are only evaluated when some part of the program requires them – perhaps never, if they are never used – and repeated evaluation of the same value is avoided wherever possible.

Pure functions and lazy evaluation bring forth a number of advantages. In particular, pure functions are reliable and predictable; they ease debugging and validation. Test cases can also be set up easily since we can be sure that nothing other than the arguments will influence a function's result. Being entirely contained within the program, the Haskell compiler can evaluate functions thoroughly in order to optimize the compiled code. However, input and output operations, which involve interaction with the world outside the confines of the program, can't be expressed through pure functions. Furthermore, in most cases I/O can't be done lazily. Since lazy computations are only performed when their values become necessary, unfettered lazy I/O would make the order of execution of the real world effects unpredictable.

There is no way to ignore this issue, as any useful program needs to do I/O, even if it is only to display a result. That being so, how do we manage actions like opening a network connection, writing a file, reading input from the outside world, or anything else that goes beyond calculating a value? The main insight is: *actions are not functions*. The IO type constructor provides a way to represent actions as Haskell values, so that we can manipulate them with pure functions. In the Prologue¹ chapter, we anticipated some of the key features of this solution. Now that we also know that IO is a monad, we can wrap up the discussion we started there.

34.1 Combining functions and I/O actions

Let's combine functions with I/O to create a full program that will:

1. Ask the user to insert a string
2. Read their string
3. Use `fmap` to apply a function `shout` that capitalizes all the letters from the string
4. Write the resulting string

```
module Main where

import Data.Char (toUpper)
import Control.Monad
```

¹ <https://en.wikibooks.org/wiki/Haskell%2FApplicative%20prologue>

```
main = putStrLn "Write your string: " >> fmap shout getLine >>= putStrLn

shout = map toUpper
```

We have a full-blown program, but we didn't include any type definitions. Which parts are functions and which are IO actions or other values? We can load our program in GHCi and check the types:

```
main :: IO ()
putStrLn :: String -> IO ()
"Write your string: " :: [Char]
(>>) :: Monad m => m a -> m b -> m b
fmap :: Functor m => (a -> b) -> m a -> m b
shout :: [Char] -> [Char]
getLine :: IO String
(>>=) :: Monad m => m a -> (a -> m b) -> m b
```

Whew, that is a lot of information there. We've seen all of this before, but let's review.

`main` is `IO ()`. That's not a function. Functions are of types `a -> b`. Our entire program is an IO action.

`putStrLn` is a function, but it results in an IO action. The "Write your string: " text is a `String` (remember, that's just a synonym for `[Char]`). It is used as an argument for `putStrLn` and is incorporated into the IO action that results. So, `putStrLn` is a function, but `putStrLn x` evaluates to an IO action. The `()` part of the IO type indicates that nothing is available to be passed on to any later functions or actions.

That last part is key. We sometimes say informally that an IO action "returns" something; however, taking that too literally leads to confusion. It is clear what we mean when we talk about *functions* returning results, but IO actions are not functions. Let's skip down to `getLine` — an IO action that *does* provide a value. `getLine` is not a function that returns a `String` because *getLine isn't a function*. Rather, `getLine` is an IO action which, when evaluated, will materialize a `String`, which can then be passed to later functions through, for instance, `fmap` and `(>>=)`.

When we use `getLine` to get a `String`, the value is monadic because it is wrapped in `IO` functor (which happens to be a monad). We cannot pass the value directly to a function that takes plain (non-monadic, or non-functorial) values. `fmap` does the work of taking a non-monadic function while passing in and returning monadic values.

As we've seen already, `(>>=)` does the work of passing a monadic value into a function that takes a non-monadic value and returns a monadic value. It may seem inefficient for `fmap` to take the non-monadic result of its given function and return a monadic value only for `(>>=)` to then pass the underlying non-monadic value to the next function. It is precisely this sort of chaining, however, that creates the reliable sequencing that make monads so effective at integrating pure functions with IO actions.

34.1.1 *do* notation review

Given the emphasis on sequencing, the `do` notation² can be especially appealing with the IO monad. Our program

² Chapter 33 on page 207

```
putStrLn "Write your string: " >> fmap shout getLine >>= putStrLn
```

could be written as:

```
do putStrLn "Write your string: "
   string <- getLine
   putStrLn (shout string)
```

34.2 The universe as part of our program

One way of viewing the IO monad is to consider IO a as a computation which provides a value of type a while changing *the state of the world* by doing input and output. Obviously, you cannot literally set the state of the world; it is hidden from you, as the IO functor is abstract (that is, you cannot dig into it to see the underlying values, a situation unlike what we have seen in the case of Maybe³).

Understand that this idea of the universe as an object affected and affecting Haskell values through IO is only a metaphor; a loose interpretation at best. The more mundane fact is that IO simply brings some very base-level operations into the Haskell language.⁴ Remember that Haskell is an abstraction, and that Haskell programs must be compiled to machine code in order to actually run. The actual workings of IO happen at a lower level of abstraction, and are wired into the very definition of the Haskell language.⁵

34.3 Pure and impure

The adjectives "pure" and "impure" often crop up while talking about I/O in Haskell. To clarify what is meant by them, we will revisit the discussion about referential transparency from the Prologue chapter⁶. Consider the following snippet:

```
sayHello :: IO String
sayHello = speakTo (\name -> "Hello, " ++ name ++ "!")

-- Usage example.
sayHello :: IO String
sayHello = speakTo (\name -> "Hello, " ++ name ++ "!")
```

In most other programming languages, which do not have separate types for I/O actions, `speakTo` would have a type akin to:

```
speakTo :: (String -> String) -> String
```

³ Chapter 31.3 on page 201

⁴ The technical term is "primitive", as in primitive operations.

⁵ The same can be said about all higher-level programming languages, of course. Incidentally, Haskell's IO operations can actually be extended via the *Foreign Function Interface* (FFI) which can make calls to C libraries. As C can use inline assembly code, Haskell can indirectly engage with anything a computer can do. Still, Haskell functions manipulate such outside operations only *indirectly* as values in IO functors.

⁶ <https://en.wikibooks.org/wiki/Haskell%2FApplicative%20prologue%23Referential%20transparency>

With such a type, however, `speakTo` would not be a function at all! Functions produce the same results when given the same arguments; the `String` delivered by `speakTo`, however, also depends on whatever is typed at the terminal prompt. In Haskell, we avoid that pitfall by returning an `IO String`, which is not a `String` but a promise that *some* `String` will be delivered by carrying out certain instructions involving I/O (in this case, the I/O consists of getting a line of input from the terminal). Though the `String` can be different each time `speakTo` is evaluated, the I/O instructions are always the same.

When we say Haskell is a purely functional language, we mean that all of its functions are *really* functions – or, in other words, that Haskell expressions are always referentially transparent. If `speakTo` had the problematic type we mentioned above, referential transparency would be violated: `sayHello` would be a `String`, and yet replacing it by any specific string would break the program.

In spite of Haskell being purely functional, `IO` actions can be said to be *impure* because their impact on the outside world are *side effects* (as opposed to the regular effects that are entirely contained within Haskell). Programming languages that lack purity may have side-effects in many other places connected with various calculations. Purely functional languages, however, assure that *even expressions with impure values are referentially transparent*. That means we can talk about, reason about and handle impurity in a purely functional way, using purely functional machinery such as functors and monads. While `IO` actions are impure, all of the Haskell functions that manipulate them remain pure.

Functional purity, coupled to the fact that I/O shows up in types, benefit Haskell programmers in various ways. The guarantees about referential transparency increase a lot the potential for compiler optimizations. `IO` values being distinguishable through types alone make it possible to immediately tell where we are engaging with side effects or opaque values. As `IO` itself is just another functor, we maintain to the fullest extent the predictability and ease of reasoning associated with pure functions.

34.4 Functional and imperative

When we introduced monads⁷, we said that a monadic expression can be interpreted as a statement of an imperative language. That interpretation is immediately compelling for `IO`, as the language around `IO` actions looks a lot like a conventional imperative language. It must be clear, however, that we are talking about an *interpretation*. We are not saying that monads or `do` notation turn Haskell into an imperative language. The point is merely that you can view and understand monadic code in terms of imperative statements. The semantics may be imperative, but the implementation of monads and (`>>=`) is still purely functional. To make this distinction clear, let's look at a little illustration:

```
int x;
scanf("%d", &x);
printf("%d\n", x);
```

⁷ Chapter 30.2 on page 192

This is a snippet of C, a typical imperative language. In it, we declare a variable `x`, read its value from user input with `scanf` and then print it with `printf`. We can, within an `IO` do block, write a Haskell snippet that performs the same function and looks quite similar:

```
x <- readLn
print x
```

Semantically, the snippets are nearly equivalent.⁸ In the C code, however, the statements directly correspond to instructions to be carried out by the program. The Haskell snippet, on the other hand, is desugared to:

```
readLn >>= \x -> print x
```

The desugared version has no statements, only functions being applied. We tell the program the order of the operations indirectly as a simple consequence of *data dependencies*: when we chain monadic computations with `(>>=)`, we get the later results by applying functions to the results of the earlier ones. It just happens that, for instance, evaluating `print x` leads to a string to be printed in the terminal.

When using monads, Haskell allows us to write code with imperative semantics while keeping the advantages of functional programming.

34.5 I/O in the libraries

So far the only I/O primitives we have used were `putStrLn` and `getLine` and small variations thereof. The standard libraries, however, offer many other useful functions and actions involving IO. We present some of the most important ones in the IO chapter in Haskell in Practice⁹, including the basic functionality needed for reading from and writing to files.

34.6 Monadic control structures

Given that monads allow us to express sequential execution of actions in a wholly general way, could we use them to implement common iterative patterns, such as loops? In this section, we will present a few of the functions from the standard libraries which allow us to do precisely that. While the examples are presented here applied to IO, keep in mind that the following ideas apply to *every* monad.

Remember, there is nothing magical about monadic values; we can manipulate them just like any other values in Haskell. Knowing that, we might think to try the following function to get five lines of user input:

```
fiveGetLines = replicate 5 getLine
```

⁸ One difference is that `x` is a mutable variable in C, and so it is possible to declare it in one statement and set its value in the next; Haskell never allows such mutability. If we wanted to imitate the C code even more closely, we could have used an `IORef`, which is a cell that contains a value which can be destructively updated. For obvious reasons, `IORefs` can only be used within the `IO` monad.

⁹ <https://en.wikibooks.org/wiki/Haskell%2FHierarchical%20libraries%2FIO>

That won't do, however (try it in GHCi!). The problem is that `replicate` produces, in this case, a list of actions, while we want an action which returns a list (that is, `IO [String]` rather than `[IO String]`). What we need is a *fold* to run down the list of actions, executing them and combining the results into a single list. As it happens, there is a Prelude function which does that: `sequence`.

```
sequence :: (Monad m) => [m a] -> m [a]
```

And so, we get the desired action with:

```
fiveGetLines = sequence $ replicate 5 getLine
```

`replicate` and `sequence` form an appealing combination; so `Control.Monad`¹⁰ offers a `replicateM` function for repeating an action an arbitrary number of times. `Control.Monad` provides a number of other convenience functions in the same spirit - monadic zips, folds, and so forth.

```
fiveGetLinesAlt = replicateM 5 getLine
```

A particularly important combination is `map` and `sequence`. Together, they allow us to make actions from a list of values, run them sequentially, and collect the results. `mapM`, a Prelude function, captures this pattern:

```
mapM :: (Monad m) => (a -> m b) -> [a] -> m [b]
```

We also have variants of the above functions with a trailing underscore in the name, such as `sequence_`, `mapM_` and `replicateM_`. These discard any final values and so are appropriate when you are only interested in performing actions. Compared with their underscore-less counterparts, these functions are like the distinction between `(>>)` and `(>>=)`. `mapM_` for instance has the following type:

```
mapM_ :: (Monad m) => (a -> m b) -> [a] -> m ()
```

Finally, it is worth mentioning that `Control.Monad` also provides `forM` and `forM_`, which are flipped versions of `mapM` and `mapM_`. `forM_` happens to be the idiomatic Haskell counterpart to the imperative for-each loop; and the type signature suggests that neatly:

```
forM_ :: (Monad m) => [a] -> (a -> m b) -> m ()
```

Exercises:

1. Using the monadic functions we have just introduced, write a function which prints an arbitrary list of values.
2. Generalize the bunny invasion example^a in the list monad chapter for an arbitrary number of generations.
3. What is the expected behavior of `sequence` for the `Maybe` monad?

^a Chapter 32.2 on page 204

¹⁰ <http://hackage.haskell.org/packages/archive/base/4.1.0.0/doc/html/Control-Monad.html>

35 The State monad

If you have programmed in any other language before, you likely wrote some functions that "kept state". For those new to the concept, a *state* is one or more variables that are required to perform some computation but are not among the arguments of the relevant function. Object-oriented languages like C++ make extensive use of state variables (in the form of member variables inside classes and objects). Procedural languages like C on the other hand typically use global variables declared outside the current scope to keep track of state.

In Haskell, however, such techniques are not as straightforward to apply. Doing so will require mutable variables which would mean that functions will have hidden dependencies, which is at odds with Haskell's functional *purity*. Fortunately, often it is possible to keep track of state in a functionally pure way. We do so by passing the state information from one function to the next, thus making the hidden dependencies explicit. The `State` type is designed to simplify this process of threading state through functions. In this chapter, we will see how it can assist us in a typical problem involving state: generating pseudo-random numbers.

35.1 Pseudo-Random Numbers

Generating actual random numbers¹ is hard. Computer programs almost always use *pseudo-random numbers*² instead. They are "pseudo" because they are not *actually* random, and that they are *known in advance*. Indeed, they are generated by algorithms (the pseudo-random number generators) which take an initial state (commonly called the *seed*) and produce from it a sequence of numbers that have the appearance of being random.³ Every time a pseudo-random number is requested, state somewhere must be updated, so that the generator can be ready for producing a fresh, different random number the next time. Sequences of pseudo-random numbers can be replicated exactly if the initial seed and the generating algorithm are known.

35.1.1 Implementation in Haskell

Producing a pseudo-random number in most programming languages is very simple: there is a function somewhere in the libraries that provides a pseudo-random value (perhaps even a truly random one, depending on how it is implemented). Haskell has a similar one in the `System.Random` module from the `random` package:

1 <https://en.wikibooks.org/wiki/%3Awikipedia%3ARandom%20number%20generation>

2 <https://en.wikibooks.org/wiki/%3Awikipedia%3APseudorandom%20number%20generator>

3 A common source of seeds is the current date and time as given by the internal clock of the computer. Assuming the clock is functioning correctly, it can provide unique seeds suitable for most day-to-day needs (as opposed to applications which demand high-quality randomness, as in cryptography or statistics).

```
GHCi> :m System.Random
GHCi> :t randomIO
randomIO :: Random a => IO a
GHCi> randomIO
-1557093684
GHCi> randomIO
1342278538
```

`randomIO` is an IO action. It couldn't be otherwise, as it makes use of mutable state, which is kept out of reach from our Haskell programs. Thanks to this hidden dependency, the pseudo-random values it gives back can be different every time.

35.1.2 Example: Rolling Dice



Figure 2 `randomRIO (1,6)`

Suppose we are coding a game in which at some point we need an element of chance. In real-life games that is often obtained by means of dice. So, let's create a dice-throwing function. We'll use the IO function `randomRIO`, which allows us to specify a range from which the pseudo-random values will be taken. For a 6 die, the call will be `randomRIO (1,6)`.

```
import Control.Applicative
import System.Random
```



```
rollDiceIO :: IO (Int, Int)
rollDiceIO = liftA2 (,) (randomRIO (1,6)) (randomRIO (1,6))
```

That function rolls two dice. Here, `liftA2` is used to make the two-argument function `(,)` work within a monad or applicative functor, in this case `IO`.⁴ It can be easily defined in terms of `(<*>)`:

```
liftA2 f u v = f <$> u <*> v
```

As for `(,)`, it is the non-infix version of the tuple constructor. That being so, the two die rolls will be returned as a tuple in `IO`.

Exercises:

1. Implement a function `rollNDiceIO :: Int -> IO [Int]` that, given an integer (a number of die rolls), returns a list of that number of pseudo-random integers between 1 and 6.

35.1.3 Getting Rid of IO

A disadvantage of `randomIO` is that it requires us to use `IO` and store our state outside the program, where we can't control what happens to it. We would rather only use I/O when there is an unavoidable reason to interact with the outside world.

To avoid bringing `IO` into play, we can build a *local* generator. The `random` and `mkStdGen` functions in `System.Random` allow us to generate tuples containing a pseudo-random number together with an updated generator to use the next time the function is called.

```
GHCi> :m System.Random
GHCi> let generator = mkStdGen 0          -- "0" is our seed
GHCi> :t generator
generator :: StdGen
GHCi> generator
1 1
GHCi> :t random
random :: (RandomGen g, Random a) => g -> (a, g)
GHCi> random generator :: (Int, StdGen)
(2092838931,1601120196 1655838864)
```

Note:

In `random generator :: (Int, StdGen)`, we use the `::` to introduce a *type annotation*, which is essentially a type signature that we can put in the middle of an expression. Here, we are saying that the expression `random generator` has type `(Int, StdGen)`. It makes sense to use a type annotation here because, as we will discuss later, `random` can produce values of different types, so if we want it to give us an `Int` we'd better specify it in some way.

⁴ If you need a refresher on applicative functors, have a look at the first section of the Prologue ^{<https://en.wikibooks.org/wiki/Haskell%2FApplicative%20prologue%23Scene%201%3A%20Applicative>}.

While we managed to avoid IO, there are new problems. First and foremost, if we want to use `generator` to get random numbers, the obvious definition...

```
GHCi> let randInt = fst . random $ generator :: Int
GHCi> randInt
2092838931
```

... is useless. It will always give back the same value, 2092838931, as the same generator in the same state will be used every time. To solve that, we can take the second member of the tuple (that is, the new generator) and feed it to a *new* call to `random`:

```
GHCi> let (randInt, generator') = random generator :: (Int, StdGen)
GHCi> randInt
2092838931
GHCi> random generator' :: (Int, StdGen) -- Using new generator' returned from
"random generator"
(-2143208520,439883729 1872071452)
```

That, of course, is clumsy and rather tedious, as we now need to deal with the fuss of carefully passing the generator around.

35.1.4 Dice without IO

We can re-do our dice throw with our new approach using the `randomR` function (which is the generator version of our `rollDiceIO` function above):

```
GHCi> randomR (1,6) (mkStdGen 0)
(6, 40014 40692)
```

The resulting tuple combines the result of throwing a single die with a new generator. A simple implementation for throwing two dice is then:

```
clumsyRollDice :: (Int, Int)
clumsyRollDice = (n, m)
  where
    (n, g) = randomR (1,6) (mkStdGen 0)
    (m, _) = randomR (1,6) g
```



Figure 3 Boxcars!^a

^a http://en.wikipedia.org/wiki/Boxcars_%28slang%29

Exercises:

1. Implement a function `rollDice :: StdGen -> ((Int, Int), StdGen)` that, given a generator, return a tuple with our random numbers as first element and the last generator as the second.

The implementation of `clumsyRollDice` works as an one-off, but we have to manually pass the generator `g` from one `where` clause to the other. This approach becomes increasingly cumbersome as our programs get more complex, which means we have more values to shift around. It is also error-prone: what if we pass one of the middle generators to the wrong line in the `where` clause?

What we really need is a way to automate the extraction of the second member of the tuple (i.e. the new generator) and feed it to a new call to `random`. This is where the `State` comes into the picture.

35.2 Introducing State

The Haskell type `State` describes *functions* that consume a state and produce both a result and an updated state, which are given back in a tuple.

The state function is wrapped by a data type definition which comes along with a `runState` accessor so that pattern matching becomes unnecessary. For our current purposes, the `State` type might be defined as:

```
newtype State s a = State { runState :: s -> (a, s) }
```

Here, `s` is the type of the state, and `a` the type of the produced result. Calling the type `State` is arguably a bit of a misnomer because the wrapped value is not the state itself but a *state processor*.

35.2.1 newtype

Note that we defined the data type with the `newtype` keyword, rather than the usual `data`. `newtype` can be used only for types with just one constructor and just one field. It ensures that the trivial wrapping and unwrapping of the single field is eliminated by the compiler. For that reason, simple wrapper types such as `State` are usually defined with `newtype`. Would defining a synonym with `type` be enough in such cases? Not really, because `type` does not allow us to define instances for the new data type, which is what we are about to do...

35.2.2 Where did the State constructor go?

In the wild, the `State` type is provided by `Control.Monad.Trans.State` in `transformers` (and is also reexported by `Control.Monad.State` in `mtl`). When you use it, you will quickly notice there is no `State` constructor available. The `transformers` package implements the `State` type in a different way. The differences do not affect how we use or understand `State`; except that, instead of a `State` constructor, `Control.Monad.Trans.State` exports a `state` function,

```
state :: (s -> (a, s)) -> State s a
```

which does the same job. As for *why* the actual implementation is not the obvious one we presented above, we will get back to that a few chapters down the road.

35.2.3 Instantiating the Monad

So far, all we have done was to wrap a function type and give it a name. There is another ingredient, however: for every type `s`, `State s` can be made a *Monad instance*, giving us very handy ways of using it.

To define a `Monad` instance, there must also be instances for `Functor` and `Applicative`. As we explained previously⁵, these superclass instances can be derived as follows from the `Monad` instance that we are about to define in more detail.

```
instance Functor (State s) where
  fmap = Control.Monad.liftM

instance Applicative (State s) where
  pure = return
  (<*>) = Control.Monad.ap
```

5 Chapter 30.5 on page 196

Exercises:

1. Reimplement these instances by using explicitly the `State` constructor and functions instead of relying on the `Monad` instance.

So let's define this instance.

```
instance Monad (State s) where
```

Note the instance is `State s`, and not just `State`: on its own, `State` can't be made an instance of `Monad`, as it takes two type parameters, rather than one. That means there are actually *many* different `State` monads, one for each possible type of state - `State String`, `State Int`, `State SomeLargeDataStructure`, and so forth. However, we only need to write one implementation of `return` and `(>>=)`; the methods will be able to deal with all choices of `s`.

The `return` function is implemented as:

```
return :: a -> State s a
return x = state ( \ s -> (x, s) )
```

Giving a value (`x`) to `return` produces a function which takes a state (`s`) and returns it unchanged, together with value we want to be returned. As a finishing step, the function is wrapped up with the `state` function.

As for binding, it can be defined like this:

```
(>>=) :: State s a -> (a -> State s b) -> State s b
p >>= k = q where
  p' = runState p          -- p' :: s -> (a, s)
  k' = runState . k       -- k' :: a -> s -> (b, s)
  q' s0 = (y, s2) where -- q' :: s -> (b, s)
    (x, s1) = p' s0      -- (x, s1) :: (a, s)
    (y, s2) = k' x s1   -- (y, s2) :: (b, s)
  q = State q'
```

We wrote the definition above in a quite verbose way, to make the steps involved easier to pinpoint. A more compact way of writing it would be:

```
p >>= k = State $ \ s0 ->
  let (x, s1) = runState p s0 -- Running the first processor on s0.
      in runState (k x) s1    -- Running the second processor on s1.
```

`(>>=)` is given a state processor (`p`) and a function (`k`) that is used to create another processor from the result of the first one. The two processors are combined into a function that takes the *initial* state (`s`) and returns the *second* result and the *third* state (i.e. the output of the second processor). Overall, `(>>=)` here allows us to run two state processors in sequence, while allowing the result of the first stage to influence what happens in the second one.

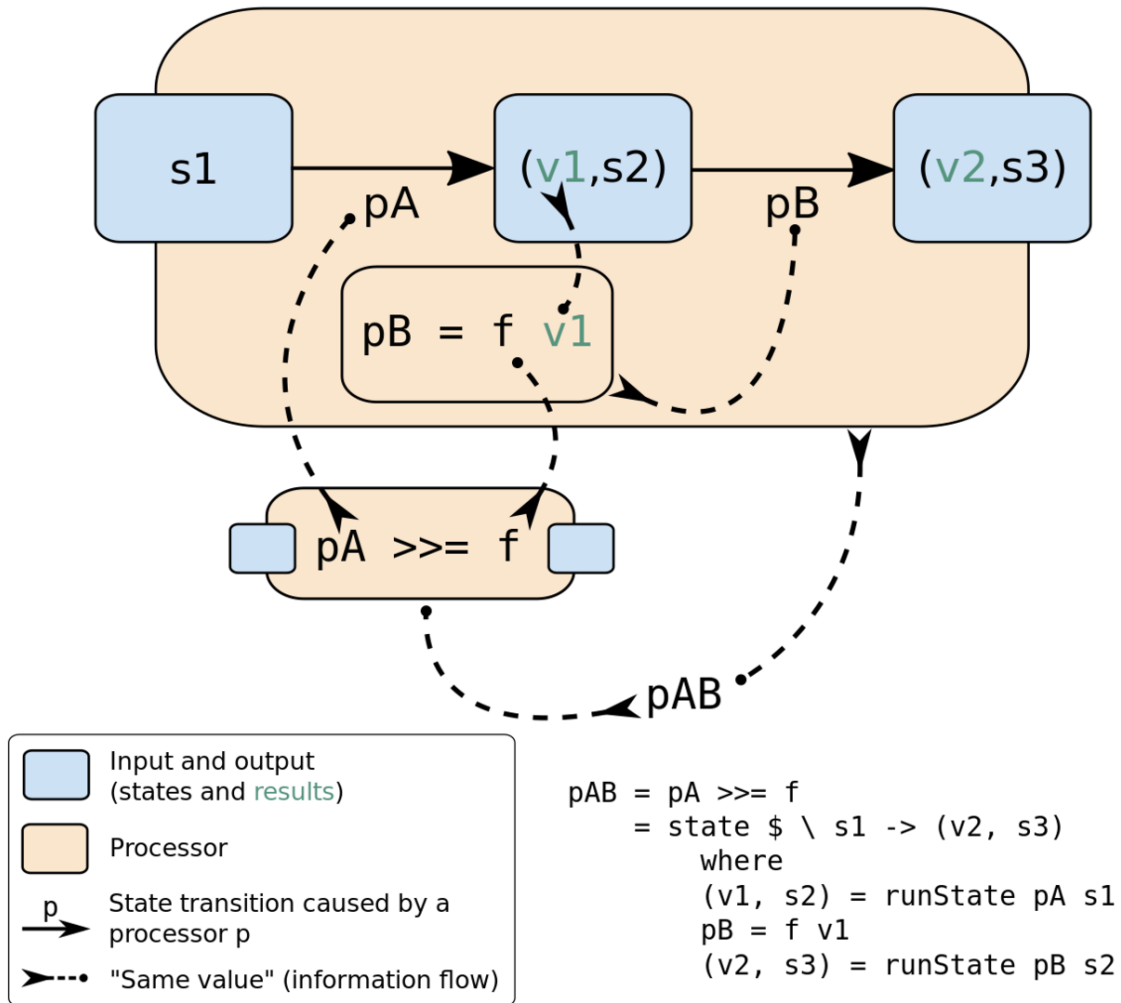

Figure 4 Schematic representation of how bind creates a new state processor (pAB) from a state processor (pA) and a processor-making function (f). $s1$, $s2$ and $s3$ are states. $v1$ and $v2$ are values. pA , pB and pAB are state processors. The wrapping and unwrapping by `State/runState` is implicit.

One detail in the implementation is how `runState` is used to undo the `State` wrapping, so that we can reach the function that will be applied to the states. The type of `runState p`, for instance, is $s \rightarrow (a, s)$.

Another way to understand this derivation of the bind operator $\gg=$ is to consider once more the explicit but cumbersome way to simulate a stateful function of type $a \rightarrow b$ by using functions of type $(a, s) \rightarrow (b, s)$, or, said another way: $a \rightarrow s \rightarrow (b, s) = a \rightarrow (s \rightarrow (b, s))$. These classes of functions pass the state on from function to function. Note that this last signature already suggests the right-hand side type in a bind operation where the abstract type $S \ b = (s \rightarrow (b, s))$.

Now that we have seen how the types seem to suggest the monadic signatures, let's consider a much more concrete question: Given two functions $f :: s \rightarrow (a, s)$ and $g :: a \rightarrow s$

-> (b, s), how do we chain them to produce a new function that passes on the intermediate state?

This question does not require thinking about monads: one option is to simply use function composition. It helps our exposition if we just write it down explicitly as a lambda expression:

```
compose :: (s -> (a,s)) ->      {- first function -}
          (a -> (s -> (b,s))) -> {- second function, note type is similar to
          (a,s) -> (b,s) -}
          s -> (b,s)           {- composed function -}
compose f g = \s0 -> let (a1, s1) = f s0 in (g a1) s1
{-This lambda expression threads both intermediate results produced by f into
those required by g -}
```

Now, if in addition to chaining the input functions, we find that the functions of signature $s \rightarrow (a,s)$ were all wrapped in an abstract datatype `Wrapped a`, and that therefore we need to call some other provided functions `wrap :: (s -> (a,s)) -> Wrapped a`, and `unwrap :: Wrapped a -> (s -> (a,s))` in order to get to the inner function, then the code changes slightly:

```
{- what happens if the type s -> (a,s) is wrapped and this new type is called
   Wrapped a -}
composeWrapped :: Wrapped a -> (a -> Wrapped b) -> Wrapped b
composeWrapped wrappedf g = wrap (\s0 -> let (a1,s1) = (unwrap wrappedf) s0 in
  (unwrap (g a1)) s1)
```

This code is the implementation of (`>>=`) shown above, with `wrap = state` and `unwrap = runState`, so we can now see how the definition of `bind` given earlier is the standard function composition for this special kind of stateful function.

This explanation does not address yet where the original functions `Wrapped a` and `a -> Wrapped b` come from in the first place, but they do explain what you can do with them once you have them.

35.2.4 Setting and Accessing the State

The monad instance allows us to manipulate various state processors, but you may at this point wonder where exactly the *original* state comes from in the first place. That issue is handily dealt with by the function `put`:

```
put newState = State $ \_ -> ((), newState)
```

Given a state (the one we want to introduce), `put` generates a state processor which ignores whatever state it receives, and gives back the state we originally provided to `put`. Since we don't care about the result of this processor (all we want to do is to replace the state), the first element of the tuple will be `()`, the universal placeholder value.⁶

As a counterpart to `put`, there is `get`:

```
get = State $ \s -> (s, s)
```

⁶ The technical term for both `()` and its type is *unit*.

The resulting state processor gives back the state `st` it is given in both as a result and as a state. That means the state will remain unchanged, and that a copy of it will be made available for us to manipulate.

35.2.5 Getting Values and State

As we have seen in the implementation of (`>>=`), `runState` is used to unwrap the `State s a` value to get the actual state processing function, which is then applied to some initial state. Other functions which are used in similar ways are `evalState` and `execState`. Given a `State a b` and an initial state, the function `evalState` will give back only the result value of the state processing, whereas `execState` will give back just the new state.

```
evalState :: State s a -> s -> a
evalState p s = fst (runState p s)

execState :: State s a -> s -> s
execState p s = snd (runState p s)
```

35.2.6 Dice and state

Time to use the `State` monad for our dice throw examples.

```
import Control.Monad.Trans.State
import System.Random
```

We want to generate `Int` dice throw results from a pseudo-random generator of type `StdGen`. Therefore, the type of our state processors will be `State StdGen Int`, which is equivalent to `StdGen -> (Int, StdGen)` bar the wrapping.

We can now implement a processor that, given a `StdGen` generator, produces a number between 1 and 6. Now, the type of `randomR` is:

```
-- The StdGen type we are using is an instance of RandomGen.
randomR :: (Random a, RandomGen g) => (a, a) -> g -> (a, g)
```

Doesn't it look familiar? If we assume `a` is `Int` and `g` is `StdGen` it becomes:

```
randomR (1, 6) :: StdGen -> (Int, StdGen)
```

We already have a state processing function! All that is missing is to wrap it with `state`:

```
rollDie :: State StdGen Int
rollDie = state $ randomR (1, 6)
```

For illustrative purposes, we can use `get`, `put` and `do`-notation to write `rollDie` in a very verbose way which displays explicitly each step of the state processing:

```
rollDie :: State StdGen Int
rollDie = do generator <- get
            let (value, newGenerator) = randomR (1,6) generator
            put newGenerator
            return value
```

Let's go through each of the steps:

1. First, we take out the pseudo-random generator from the monadic context with `<-`, so that we can manipulate it.
2. Then, we use the `randomR` function to produce an integer between 1 and 6 using the generator we took. We also store the new generator graciously returned by `randomR`.
3. We then set the state to be the `newGenerator` using `put`, so that any further `randomR` in the `do`-block, or further on in a `(>>=)` chain, will use a different pseudo-random generator.
4. Finally, we inject the result back into the `State StdGen` monad using `return`.

We can finally use our monadic die. As before, the initial generator state itself is produced by the `mkStdGen` function.

```
GHCi> evalState rollDie (mkStdGen 0)
6
```

Why have we involved monads and built such an intricate framework only to do exactly what `fst $ randomR (1,6)` already does? Well, consider the following function:

```
rollDice :: State StdGen (Int, Int)
rollDice = liftA2 (,) rollDie rollDie
```

We obtain a function producing *two* pseudo-random numbers in a tuple. Note that these are in general different:

```
GHCi> evalState rollDice (mkStdGen 666)
(6,1)
```

Under the hood, state is being passed through `(>>=)` from one `rollDie` computation to the other. Doing that was previously very clunky using `randomR (1,6)` alone because we had to pass state manually. Now, the monad instance is taking care of that for us. Assuming we know how to use the lifting functions, constructing intricate combinations of pseudo-random numbers (tuples, lists, whatever) has suddenly become much easier.

Exercises:

1. Similarly to what was done for `rollNDiceIO`, implement a function `rollNDice :: Int -> State StdGen [Int]` that, given an integer, returns a list with that number of pseudo-random integers between 1 and 6.
2. Write an instance of `Functor` for `State s`. Your final answer should not use anything that mentions `Monad` in its type (that is, `return`, `(>>=)`, etc.). Then, explain in a few words what the `fmap` you wrote does. (Hint: If you get stuck, have another look at the comments about `liftM` at the very end of Understanding monads^a.)
3. Besides `put` and `get`, there are also

```
modify :: (s -> s) -> State s ()
```

 which modifies the current state using a function, and

```
gets :: (s -> a) -> State s a
```

 which produces a modified copy of the state while leaving the state itself unchanged. Write implementations for them.

^a Chapter 30.5 on page 196

35.3 Pseudo-random values of different types

Until now, we have used only `Int` as type of the value produced by the pseudo-random generator. However, looking at the type of `randomR` shows we are not restricted to `Int`. It can generate values of any type in the `Random` class from `System.Random`⁷. There already are instances for `Int`, `Char`, `Integer`, `Bool`, `Double` and `Float`, so you can immediately generate any of those.

Because `State StdGen` is "agnostic" in regard to the type of the pseudo-random value it produces, we can write a similarly "agnostic" function that provides a pseudo-random value of unspecified type (as long as it is an instance of `Random`):

```
getRandom :: Random a => State StdGen a
getRandom = State random
```

Compared to `rollDie`, this function does not specify the `Int` type in its signature and uses `random` instead of `randomR`; otherwise, it is just the same. `getRandom` can be used for any instance of `Random`:

```
GHCi> evalState getRandom (mkStdGen 0) :: Bool
True
GHCi> evalState getRandom (mkStdGen 0) :: Char
'\64685'
GHCi> evalState getRandom (mkStdGen 0) :: Double
0.9872770354820595
GHCi> evalState getRandom (mkStdGen 0) :: Integer
2092838931
```

Indeed, it becomes quite easy to conjure all these at once:

```
someTypes :: State StdGen (Int, Float, Char)
someTypes = liftA3 (,,) getRandom getRandom getRandom

allTypes :: State StdGen (Int, Float, Char, Integer, Double, Bool, Int)
allTypes = (,,,,,) <$> getRandom
          <*> getRandom
          <*> getRandom
          <*> getRandom
          <*> getRandom
          <*> getRandom
          <*> getRandom
```

For writing `allTypes`, there is no `liftA7`⁸, and so we resort to plain old `<*>` instead. Using it, we can apply the tuple constructor to each of the seven random values in the `State StdGen` monadic context.

`allTypes` provides pseudo-random values for all default instances of `Random`; an additional `Int` is inserted at the end to prove that the generator is not the same, as the two `Int`s will be different.

```
GHCi> evalState allTypes (mkStdGen 0)
GHCi>
(2092838931,9.953678e-4,'\825586',-868192881,0.4188001483955421,False,316817438)
```

⁷ <http://hackage.haskell.org/packages/archive/random/latest/doc/html/System-Random.html>

⁸ Beyond `liftA3`, the standard libraries only provide the monad-only `liftM4` and `liftM5` in `Control.Monad`.

Exercises:

1. If you are not convinced that `State` is worth using, try to implement a function equivalent to `evalState allTypes` without making use of monads, i.e. with an approach similar to `clumsyRollDice` above.

36 Alternative and MonadPlus

In our studies so far, we saw that both `Maybe` and lists can represent computations with a varying number of results. We use `Maybe` to indicate a computation can fail somehow (that is, it can have either zero results or one result), and we use lists for computations that can have many possible results (ranging from zero to arbitrarily many results). In both of these cases, one useful operation is amalgamating *all* possible results from multiple computations into a single computation. With lists, for instance, that would amount to concatenating lists of possible results. The `Alternative` class captures this amalgamation in a general way.

36.1 Definition

Note:

The `Alternative` class and its methods can be found in the `Control.Applicativea` module.

^a <http://hackage.haskell.org/packages/archive/base/latest/doc/html/Control-Applicative.html>

`Alternative` is a subclass of `Applicative` whose instances must define, at a minimum, the following two methods:

```
class Applicative f => Alternative f where
  empty :: f a
  (<|>) :: f a -> f a -> f a
```

`empty` is an applicative computation with zero results, while `(<|>)` is a binary function which combines two computations.

Here are the two instance definitions for `Maybe` and lists:

```
instance Alternative Maybe where
  empty = Nothing
  -- Note that this could have been written more compactly.
  Nothing <|> Nothing = Nothing -- 0 results + 0 results = 0 results
  Just x <|> Nothing = Just x -- 1 result + 0 results = 1 result
  Nothing <|> Just x = Just x -- 0 results + 1 result = 1 result
  Just x <|> Just y = Just x -- 1 result + 1 result = 1 result:
  -- Maybe can only hold up to one result,
  -- so we discard the second one.

instance Alternative [] where
  empty = []
  (<|>) = (++) -- length xs + length ys = length (xs ++ ys)
```

36.2 Example: parallel parsing

Traditional input parsing involves functions which consume an input one character at a time. That is, a parsing function takes an input string and chops off (i.e. "consumes") characters from the front if they satisfy certain criteria. For example, you could write a function which consumes one uppercase character. If the characters on the front of the string don't satisfy the given criteria, the parser has *failed*. In the example below, for instance, we consume a digit in the input and return the digit that was parsed. The possibility of failure is expressed by using `Maybe`.

```
digit :: Int -> String -> Maybe Int
digit _ [] = Nothing
digit i (c:_) | i > 9 || i < 0 = Nothing
               | otherwise     = do
    if [c] == show i then Just i else Nothing
```

The guards assure that the `Int` we are checking for is a single digit. Otherwise, we are just checking that the first character of our `String` matches the digit we are checking for. If it passes, we return the digit wrapped in a `Just`. The `do`-block assures that any failed pattern match will result in returning `Nothing`.

Now, `(<|>)` can be used to run two parsers *in parallel*. That is, we use the result of the first one if it succeeds, and otherwise, we use the result of the second. If both fail, then the combined parser returns `Nothing`. We can use `digit` with `(<|>)` to, for instance, parse strings of binary digits:

```
binChar :: String -> Maybe Int
binChar s = digit 0 s <|> digit 1 s
```

Parser libraries often make use of `Alternative` in this way. Two examples are `(+++)` in `Text.ParserCombinators.ReadP`¹ and `(<|>)` in `Text.ParserCombinators.Parsec.Prim`². This usage pattern can be described in terms of *choice*. For instance, if we want to give `binChar` a string that will be successfully parsed, we have two choices: either to begin the string with '0' or with '1'.

36.3 MonadPlus

The `MonadPlus` class is closely related to `Alternative`:

```
class Monad m => MonadPlus m where
    mzero :: m a
    mplus :: m a -> m a -> m a
```

Its definition is the same of `Alternative`, except for different method names and the `Applicative` constraint being changed into `Monad`. Unsurprisingly, for types that have instances of both `Alternative` and `MonadPlus`, `mzero` and `mplus` should be equivalent to `empty` and `(<|>)` respectively.

1 <http://hackage.haskell.org/packages/archive/base/latest/doc/html/Text-ParserCombinators-ReadP.html>
 2 <http://hackage.haskell.org/packages/archive/parsec/latest/doc/html/Text-ParserCombinators-Parsec-Prim.html>

One might legitimately wonder why the seemingly redundant `MonadPlus` class exists. Part of the reason is historical: just like `Monad` existed in Haskell long before `Applicative` was introduced, `MonadPlus` is much older than `Alternative`. Beyond such accidents, there are additional expectations (ones that do not apply to `Alternative`) about how the `MonadPlus` methods should interact with the `Monad`, and therefore indicating that something is a `MonadPlus` is a stronger claim than indicating that it is both an `Alternative` and a `Monad`. We will make some additional considerations about this issue in the following section.

36.4 Alternative and MonadPlus laws

Like most general-purpose classes, `Alternative` and `MonadPlus` are expected to follow a handful of laws. However, there isn't universal agreement on what the full set of laws should look like. The most commonly adopted laws, and the most crucial for providing intuition about `Alternative`, say that `empty` and `(<|>)` form a *monoid*. By that, we mean:

```
-- empty is a neutral element
empty <|> u = u
u <|> empty = u
-- (<|>) is associative
u <|> (v <|> w) = (u <|> v) <|> w
```

There is nothing fancy about "forming a monoid": in the above, "neutral element" and "associative" here is just like how addition of integer numbers is said to be associative and to have zero as neutral element. In fact, this analogy is the source of the names of the `MonadPlus` methods, `mzero` and `mplus`.

As for `MonadPlus`, at a minimum there usually are the monoid laws, which correspond exactly to the ones just above...

```
mzero `mplus` m = m
m `mplus` mzero = m
m `mplus` (n `mplus` o) = (m `mplus` n) `mplus` o
```

... plus the additional two laws, quoted by the `Control.Monad`³ documentation:

```
mzero >>= f = mzero -- left zero
m >> mzero = mzero -- right zero
```

If `mzero` is interpreted as a failed computation, these laws state that a failure within a chain of monadic computations leads to the failure of the whole chain.

We will touch upon some additional suggestions of laws for `Alternative` and `MonadPlus` at the end of the chapter.

36.5 Useful functions

In addition to `(<|>)` and `empty`, there are two other general-purpose functions in the base libraries involving `Alternative`.

³ <http://hackage.haskell.org/packages/archive/base/latest/doc/html/Control-Monad.html>

36.5.1 asum

A common task when working with `Alternative` is taking a list of alternative values, e.g. `[Maybe a]` or `[[a]]`, and folding it down with `(<|>)`. The function `asum`, from `Data.Foldable` fulfills this role:

```
asum :: (Alternative f, Foldable t) => t (f a) -> f a
asum = foldr (<|>) empty
```

In a sense, `asum` generalizes the list-specific `concat` operation. Indeed, the two are equivalent when the lists are the `Alternative` being used. For `Maybe`, `asum` finds the first `Just x` in the list and returns `Nothing` if there aren't any.

It should also be mentioned that `msum`, available from both `'Data.Foldable'` and `'Control.Monad'`, is just `asum` specialised to `MonadPlus`.

```
msum :: (MonadPlus m, Foldable t) => t (m a) -> m a
```

36.5.2 guard

When discussing the list monad⁴ we noted how similar it was to list comprehensions, but we didn't discuss how to mirror list comprehension filtering. The `guard` function from `Control.Monad` allows us to do exactly that.

Consider the following comprehension which retrieves all pythagorean triples⁵ (i.e. trios of integer numbers which work as the lengths of the sides for a right triangle). First we'll examine the brute-force approach. We'll use a boolean condition for filtering; namely, Pythagoras' theorem:

```
pythags = [ (x, y, z) | z <- [1..], x <- [1..z], y <- [x..z], x2 + y2 == z2 ]
```

The translation of the comprehension above to a list monad do-block is:

```
pythags = do
  z <- [1..]
  x <- [1..z]
  y <- [x..z]
  guard (x2 + y2 == z2)
  return (x, y, z)
```

The `guard` function can be defined for all `Alternatives` like this:

```
guard :: Alternative m => Bool -> m ()
guard True  = pure ()
guard _    = empty
```

`guard` will reduce a do-block to `empty` if its predicate is `False`. Given the left zero law...

```
mzero >>= f = mzero
-- Or, equivalently:
empty >>= f = empty
```

4 Chapter 32 on page 203

5 https://en.wikipedia.org/wiki/Pythagorean_triple

... an `empty` on the left-hand side of an `>>=` operation will produce `empty` again. As `do`-blocks are decomposed to lots of expressions joined up by `(>>=)`, an `empty` at any point will cause the entire `do`-block to become `empty`.

Let's examine in detail what `guard` does in the `pythags`. First, here is `guard` defined for the list monad:

```
-- guard :: Bool -> [()]
guard True  = [()]
guard _    = []
```

Basically, `guard blocks off` a route. In `pythags`, we want to block off all the routes (or combinations of `x`, `y` and `z`) where `x2 + y2 == z2` is `False`. Let's look at the expansion of the above `do`-block to see how it works:

```
pythags =
  [1..] >>= \z ->
  [1..z] >>= \x ->
  [x..z] >>= \y ->
  guard (x2 + y2 == z2) >>= \_ ->
  return (x, y, z)
```

Replacing `>>=` and `return` with their definitions for the list monad (and using some `let`-bindings to keep it readable), we obtain:

```
pythags =
  let ret x y z = [(x, y, z)]
      gd z x y = concatMap (\_ -> ret x y z) (guard $ x2 + y2 == z2)
      doY z x = concatMap (gd z x) [x..z]
      doX z = concatMap (doY z ) [1..z]
      doZ = concatMap (doX ) [1..]
  in doZ
```

Remember that `guard` returns the empty list in the case of its argument being `False`. Mapping across the empty list produces the empty list, no matter what function you pass in. So an empty list produced by the call to `guard` in `gd` will cause `gd` to produce an empty list, with `_ -> ret x y z`, which would otherwise add a result, not being actually called.

To understand why this matters, think about list-computations as a tree. With our Pythagorean triple algorithm, we need a branch starting from the top for every choice of `z`, then a branch from each of these branches for every value of `x`, then from each of these, a branch for every value of `y`. So the tree looks like this:



Each combination of `z`, `x` and `y` represents a route through the tree. Once all the functions have been applied, the results of each branch are concatenated together, starting from the

bottom. Any route where our predicate doesn't hold evaluates to an empty list, and so has no impact on this concatenation.

36.6 Exercises

Exercises:

1. Prove the `Alternative` monoid laws for `Maybe` and lists.
2. We could augment the parser from the parallel parsing example so that it would handle any character, in the following manner:

```
-- | Consume a given character in the input, and return
--   the character we just consumed, paired with rest of
--   the string. We use a do-block so that if the
--   pattern match fails at any point, 'fail' of the
--   Maybe monad (i.e. Nothing) is returned.
char :: Char -> String -> Maybe (Char, String)
char c s = do
  let (c':s') = s
      if c == c' then Just (c, s') else Nothing
```

It would then be possible to write a `hexChar` function which parses any valid hexadecimal character (0-9 or a-f). Try writing this function (hint: `map digit [0..9] :: [String -> Maybe Int]`).

3. Use `guard` and the `Applicative` combinators (`pure`, `(<*>`), `(<*>`), etc.) to implement `safeLog` from the `Maybe` monad chapter^a. Do not use the `Monad` combinators (`return`, `(>>=)`, `(>>)`, etc.).

^a Chapter 31 on page 199

36.7 Relationship with monoids

While discussing the `Alternative` laws above, we alluded to the mathematical concept of monoids. There is in fact already a `Monoid` class in Haskell (defined in `Data.Monoid`⁶). A thorough presentation of monoid will be given in a later chapter⁷. However for now it suffices to say that a minimal definition of `Monoid` implements two methods; namely, a neutral element (or 'zero') and an associative binary operation (or 'plus').

```
class Monoid m where
  mempty  :: m
  mappend :: m -> m -> m
```

For example, lists form a simple monoid:

```
instance Monoid [a] where
```

⁶ <http://hackage.haskell.org/packages/archive/base/latest/doc/html/Data.Monoid.html>

⁷ Chapter 39 on page 253

```
mempty = []
mappend = (++)
```

Looks familiar, doesn't it? In spite of the uncanny resemblance to `Alternative` and `MonadPlus`, there is a key difference. Note the use of `[a]` instead of `[]` in the instance declaration. Monoids are not necessarily "wrappers" of anything, or parametrically polymorphic. For instance, the integer numbers form a monoid under addition with 0 as neutral element. `Alternative` is a separate type class because it captures a specific sort of monoid with distinctive properties – for instance, a binary operation `(<|>) :: Alternative f => f a -> f a -> f a` that is intrinsically linked to an `Applicative` context.

36.8 Other suggested laws

Note:

Consider this as a bonus section. While it is good to be aware of there being various takes on these laws, the whole issue is, generally speaking, not worth losing sleep over.

Beyond the commonly assumed laws mentioned a few sections above, there are a handful of others which make sense from certain perspectives, but do not hold for all existing instances of `Alternative` and `MonadPlus`. The current `MonadPlus`, in particular, might be seen as an intersection between a handful of hypothetical classes that would have additional laws.

The following two additional laws are commonly suggested for `Alternative`. While they do hold for both `Maybe` and lists, there are counterexamples in the core libraries. Also note that, for `Alternatives` that are also `MonadPlus`, the `mzero` laws mentioned earlier are not a consequence of these laws.

```
(f <|> g) <*> a = (f <*> a) <|> (g <*> a) -- right distributivity (of <*>)
empty <*> a = empty -- right absorption (for <*>)
```

As for `MonadPlus`, a common suggestion is the *left distribution* law, which holds for lists, but not for `Maybe`:

```
(m `mplus` n) >>= k = (m >>= k) `mplus` (n >>= k) -- left distribution
```

Conversely, the *left catch* law holds for `Maybe` but not for lists:

```
return x `mplus` m = return x -- left catch
```

It is generally assumed that at least one of left distribution and left catch will hold for any `MonadPlus` instance.

Finally, it is worth noting that there are divergences even about the monoid laws. One case sometimes raised against them is that for certain non-determinism monads typically expressed in terms of `MonadPlus` the key laws are left zero and left distribution, while the monoid laws in such cases lead to difficulties and should be relaxed or dropped entirely.

Some entirely optional further reading, for the curious reader:

- The Haskell Wiki on MonadPlus⁸ (note that this debate long predates the existence of `Alternative`).
- *Distinction between typeclasses `MonadPlus`, `Alternative`, and `Monoid`?⁹ and *Confused by the meaning of the 'Alternative' type class and its relationship to other type classes*¹⁰ at Stack Overflow (detailed overviews of the *status quo* reflected by the documentation of the relevant libraries as of GHC 7.x/8.x – as opposed to the 2010 Haskell Report, which is less prescriptive on this matter.)*
- *From monoids to near-semirings: the essence of `MonadPlus` and `Alternative`* by Rivas, Jaskelioff and Schrijvers¹¹ (a formulation that includes, beyond the monoid laws, right distribution and right absorption for `Alternative`, as well as left zero and left distribution for `MonadPlus`).
- Wren Romano on `MonadPlus` and seminearrings¹² (argues that the `MonadPlus` right zero law is too strong).
- Oleg Kiselyov on the `MonadPlus` laws¹³ (argues against the monoid laws in the case of non-determinism monads).
- *Must `mplus` always be associative?* at Stack Overflow¹⁴ (a discussion about the merits of the monoid laws of `MonadPlus`).

8 <http://www.haskell.org/haskellwiki/MonadPlus>

9 <http://stackoverflow.com/q/10167879/2751851>

10 <http://stackoverflow.com/q/13080606/2751851>

11 <https://lirias.kuleuven.be/handle/123456789/499951>

12 <http://winterkoninkje.dreamwidth.org/90905.html>

13 <http://okmij.org/ftp/Computation/monads.html#monadplus>

14 <http://stackoverflow.com/q/15722906/2751851>

37 Monad transformers

We have seen how monads can help handling IO actions, `Maybe`, lists, and state. With monads providing a common way to use such useful general-purpose tools, a natural thing we might want to do is using the capabilities of *several* monads at once. For instance, a function could use both I/O and `Maybe` exception handling. While a type like `IO (Maybe a)` would work just fine, it would force us to do pattern matching within IO do-blocks to extract values, something that the `Maybe` monad was meant to spare us from.

Enter **monad transformers**: special types that allow us to roll two monads into a single one that shares the behavior of both.

37.1 Passphrase validation

Consider a real-life problem for IT staff worldwide: getting users to create strong passphrases. One approach: force the user to enter a minimum length with various irritating requirements (such as at least one capital letter, one number, one non-alphanumeric character, etc.)

Here's a Haskell function to acquire a passphrase from a user:

```
getPassphrase :: IO (Maybe String)
getPassphrase = do s <- getLine
                  if isValid s then return $ Just s
                              else return Nothing

-- The validation test could be anything we want it to be.
isValid :: String -> Bool
isValid s = length s >= 8
          && any isAlpha s
          && any isNumber s
          && any isPunctuation s
```

First and foremost, `getPassphrase` is an IO action, as it needs to get input from the user. We also use `Maybe`, as we intend to return `Nothing` in case the password does not pass the `isValid`. Note, however, that we aren't actually using `Maybe` as a monad here: the `do` block is in the IO monad, and we just happen to `return` a `Maybe` value inside it.

Monad transformers not only make it easier to write `getPassphrase` but also simplify all the code instances. Our passphrase acquisition program could continue like this:

```
askPassphrase :: IO ()
askPassphrase = do putStrLn "Insert your new passphrase:"
                  maybe_value <- getPassphrase
                  case maybe_value of
                    Just value -> do putStrLn "Storing in database..." -- do
stuff
                    Nothing -> putStrLn "Passphrase invalid."
```

The code uses one line to generate the `maybe_value` variable followed by further validation of the passphrase.

With monad transformers, we will be able to extract the passphrase in one go — without any pattern matching (or equivalent bureaucracy like `isJust`). The gains for our simple example might seem small but will scale up for more complex situations.

37.2 A simple monad transformer: MaybeT

To simplify `getPassphrase` and the code that uses it, we will define a *monad transformer* that gives the IO monad some characteristics of the `Maybe` monad; we will call it `MaybeT`. That follows a convention where monad transformers have a "T" appended to the name of the monad whose characteristics they provide.

`MaybeT` is a wrapper around `m (Maybe a)`, where `m` can be any monad (IO in our example):

```
newtype MaybeT m a = MaybeT { runMaybeT :: m (Maybe a) }
```

This data type definition specifies a `MaybeT` type constructor, parameterized over `m`, with a term constructor, also called `MaybeT`, and a convenient accessor function `runMaybeT`, with which we can access the underlying representation.

The whole point of monad transformers is that *they transform monads into monads*; and so we need to make `MaybeT m` an instance of the `Monad` class:

```
instance Monad m => Monad (MaybeT m) where
  return = MaybeT . return . Just

  -- The signature of (>>=), specialized to MaybeT m:
  -- (>>=) :: MaybeT m a -> (a -> MaybeT m b) -> MaybeT m b
  x >>= f = MaybeT $ do maybe_value <- runMaybeT x
                       case maybe_value of
                         Nothing    -> return Nothing
                         Just value  -> runMaybeT $ f value
```

It would also have been possible (though arguably less readable) to write the return function as: `return = MaybeT . return . return`.

Starting from the first line of the `do` block:

- First, the `runMaybeT` accessor unwraps `x` into an `m (Maybe a)` computation. That shows us that the whole `do` block is in `m`.
- Still in the first line, `<-` extracts a `Maybe a` value from the unwrapped computation.
- The `case` statement tests `maybe_value`:
 - With `Nothing`, we return `Nothing` into `m`;
 - With `Just`, we apply `f` to the value from the `Just`. Since `f` has `MaybeT m b` as result type, we need an extra `runMaybeT` to put the result back into the `m` monad.
- Finally, the `do` block as a whole has `m (Maybe b)` type; so it is wrapped with the `MaybeT` constructor.

It may look a bit complicated; but aside from the copious amounts of wrapping and unwrapping, the implementation does the same as the familiar bind operator of `Maybe`:

```
-- (>>=) for the Maybe monad
maybe_value >>= f = case maybe_value of
    Nothing -> Nothing
    Just value -> f value
```

Why use the `MaybeT` constructor before the `do` block while we have the accessor `runMaybeT` within `do`? Well, the `do` block must be in the `m` monad, not in `MaybeT m` (which lacks a defined bind operator at this point).

Technically, this is all we need; however, it is convenient to make `MaybeT m` an instance of a few other classes:

```
instance Monad m => Alternative (MaybeT m) where
    empty = MaybeT $ return Nothing
    x <|> y = MaybeT $ do maybe_value <- runMaybeT x
                        case maybe_value of
                            Nothing -> runMaybeT y
                            Just _ -> return maybe_value

instance Monad m => MonadPlus (MaybeT m) where
    mzero = empty
    mplus = (<|>)

instance MonadTrans MaybeT where
    lift = MaybeT . (liftM Just)
```

`MonadTrans` implements the `lift` function, so we can take functions from the `m` monad and bring them into the `MaybeT m` monad in order to use them in `do` blocks. As for `Alternative` and `MonadPlus`, since `Maybe` is an instance of those class it makes sense to make the `MaybeT m` an instance too.

37.2.1 Passphrase validation, simplified

The above passphrase validation example can now be simplified using the `MaybeT` monad transformer as follows:

```
getPassphrase :: MaybeT IO String
getPassphrase = do s <- lift getLine
                  guard (isValid s) -- Alternative provides guard.
                  return s

askPassphrase :: MaybeT IO ()
askPassphrase = do lift $ putStrLn "Insert your new passphrase:"
                  value <- getPassphrase
                  lift $ putStrLn "Storing in database..."
```

The code is now simpler, especially in the user function `askPassphrase`. Most importantly, we do not have to manually check whether the result is `Nothing` or `Just`: the bind operator takes care of that for us.

Note how we use `lift` to bring the functions `getLine` and `putStrLn` into the `MaybeT IO` monad. Also, since `MaybeT IO` is an instance of `Alternative`, checking for passphrase validity can be taken care of by a `guard` statement, which will return `empty` (i.e. `IO Nothing`) in case of a bad passphrase.

Incidentally, with the help of `MonadPlus` it also becomes very easy to ask the user *ad infinitum* for a valid passphrase:

```
askPassphrase :: MaybeT IO ()
askPassphrase = do lift $ putStrLn "Insert your new passphrase:"
                  value <- msum $ repeat getPassphrase
                  lift $ putStrLn "Storing in database..."
```

37.3 A plethora of transformers

The `transformers` package provides modules with transformers for many common monads (`MaybeT`, for instance, can be found in `Control.Monad.Trans.Maybe`¹). These are defined consistently with their non-transformer versions; that is, the implementation is basically the same except with the extra wrapping and unwrapping needed to thread the other monad. From this point on, we will use **precursor monad** to refer to the non-transformer monad (e.g. `Maybe` in `MaybeT`) on which a transformer is based and **base monad** to refer to the other monad (e.g. `IO` in `MaybeT IO`) on which the transformer is applied.

To pick an arbitrary example, `ReaderT Env IO String` is a computation which involves reading values from some environment of type `Env` (the semantics of `Reader`, the precursor monad) and performing some `IO` in order to give a value of type `String`. Since the `bind` operator and `return` for the transformer mirror the semantics of the precursor monad, a `do` block of type `ReaderT Env IO String` will, from the outside, look a lot like a `do` block of the `Reader` monad, except that `IO` actions become trivial to embed by using `lift`.

37.3.1 Type juggling

We have seen that the type constructor for `MaybeT` is a wrapper for a `Maybe` value in the base monad. So, the corresponding accessor `runMaybeT` gives us a value of type `m (Maybe a)` - i.e. a value of the precursor monad returned in the base monad. Similarly, for the `ListT` and `ExceptT` transformers, which are built around lists and `Either` respectively:

```
runListT :: ListT m a -> m [a]
```

and

```
runExceptT :: ExceptT e m a -> m (Either e a)
```

Not all transformers are related to their precursor monads in this way, however. Unlike the precursor monads in the two examples above, the `Writer`, `Reader`, `State`, and `Cont` monads have neither multiple constructors nor constructors with multiple arguments. For that reason, they have `run...` functions which act as simple unwrappers, analogous to the `run...T` of the transformer versions. The table below shows the result types of the `run...` and `run...T` functions in each case, which may be thought of as the types wrapped by the base and transformed monads respectively.²

1 <http://hackage.haskell.org/packages/archive/transformers/latest/doc/html/Control-Monad-Trans-Maybe.html>

2 The wrapping interpretation is only literally true for versions of the `mtl` package older than 2.0.0.0.

Precursor	Transformer	Original Type (“wrapped” by precursor)	Combined Type (“wrapped” by transformer)
Writer	WriterT	(a, w)	m (a, w)
Reader	ReaderT	r -> a	r -> m a
State	StateT	s -> (a, s)	s -> m (a, s)
Cont	ContT	(a -> r) -> r	(a -> m r) -> m r

Notice that the precursor monad type constructor is absent in the combined types. Without interesting data constructors (of the sort that `Maybe` and lists have), there is no reason to retain the precursor monad type after unwrapping the transformed monad. It is also worth noting that in the latter three cases we have function types being wrapped. `StateT`, for instance, turns state-transforming functions of the form `s -> (a, s)` into state-transforming functions of the form `s -> m (a, s)`; only the result type of the wrapped function goes into the base monad. `ReaderT` is analogous. `ContT` is different because of the semantics of `Cont` (the *continuation* monad): the result types of both the wrapped function and its function argument must be the same, and so the transformer puts both into the base monad. In general, there is no magic formula to create a transformer version of a monad; the form of each transformer depends on what makes sense in the context of its non-transformer type.

37.4 Lifting

We will now have a more detailed look at the `lift` function, which is critical in day-to-day use of monad transformers. The first thing to clarify is the name “lift”. One function with a similar name that we already know is `liftM`. As we have seen in [Understanding monads³](#), it is a monad-specific version of `fmap`:

```
liftM :: Monad m => (a -> b) -> m a -> m b
```

`liftM` applies a function `(a -> b)` to a value within a monad `m`. We can also look at it as a function of just one argument:

```
liftM :: Monad m => (a -> b) -> (m a -> m b)
```

`liftM` converts a plain function into one that acts within `m`. By “lifting”, we refer to bringing something into something else — in this case, a function into a monad.

`liftM` allows us to apply a plain function to a monadic value without needing `do`-blocks or other such tricks:

bind notation

```
monadicValue >>=
  \x -> return (f x)
```

do notation

```
do x <- monadicValue
  return (f x)
```

liftM

```
liftM f monadicValue
```

³ Chapter 30.5 on page 196

The `lift` function plays an analogous role when working with monad transformers. It brings (or, to use another common word for that, *promotes*) base monad computations to the combined monad. By doing so, it allows us to easily insert base monad computations as part of a larger computation in the combined monad.

`lift` is the single method of the `MonadTrans` class, found in `Control.Monad.Trans.Class`⁴. All monad transformers are instances of `MonadTrans`, and so `lift` is available for them all.

```
class MonadTrans t where
  lift :: (Monad m) => m a -> t m a
```

There is a variant of `lift` specific to IO operations, called `liftIO`, which is the single method of the `MonadIO` class in `Control.Monad.IO.Class`⁵.

```
class (Monad m) => MonadIO m where
  liftIO :: IO a -> m a
```

`liftIO` can be convenient when multiple transformers are stacked into a single combined monad. In such cases, IO is always the innermost monad, and so we typically need more than one `lift` to bring IO values to the top of the stack. `liftIO` is defined for the instances in a way that allows us to bring an IO value from any depth while writing the function a single time.

37.4.1 Implementing `lift`

Implementing `lift` is usually pretty straightforward. Consider the `MaybeT` transformer:

```
instance MonadTrans MaybeT where
  lift m = MaybeT (liftM Just m)
```

We begin with a monadic value of the base monad. With `liftM` (`fmap` would have worked just as fine), we slip the precursor monad (through the `Just` constructor) underneath, so that we go from `m a` to `m (Maybe a)`. Finally, we wrap things up with the `MaybeT` constructor. Note that the `liftM` here works in the base monad, just like the `do`-block wrapped by `MaybeT` in the implementation of `(>>=)` we saw early on was in the base monad.

⁴ <http://hackage.haskell.org/packages/archive/transformers/latest/doc/html/Control-Monad-Trans-Class.html>

⁵ <http://hackage.haskell.org/packages/archive/transformers/latest/doc/html/Control-Monad-IO-Class.html>

Exercises:

1. Why is it that the `lift` function has to be defined separately for each monad, where as `liftM` can be defined in a universal way?
2. `Identity` is a trivial functor, defined in `Data.Functor.Identity` as:

```
newtype Identity a = Identity { runIdentity :: a }
```

It has the following `Monad` instance:

```
instance Monad Identity where
  return a = Identity a
  m >>= k = k (runIdentity m)
```

Implement a monad transformer `IdentityT`, analogous to `Identity` but wrapping values of type `m a` rather than `a`. Write at least its `Monad` and `MonadTrans` instances.

37.5 Implementing transformers

37.5.1 The State transformer

As an additional example, we will now have a detailed look at the implementation of `StateT`. You might want to review the section on the `State` monad⁶ before continuing.

Just as the `State` monad might have been built upon the definition `newtype State s a = State { runState :: (s -> (a,s)) }`, the `StateT` transformer is built upon the definition:

```
newtype StateT s m a = StateT { runStateT :: (s -> m (a,s)) }
```

`StateT s m` will have the following `Monad` instance, here shown alongside the one for the base state monad:

State

```
newtype State s a =
  State { runState :: (s -> (a,s)) }

instance Monad (State s) where
  return a      = State $ \s -> (a,s)
  (State x) >>= f = State $ \s ->
    let (v,s') = x s
    in runState (f v) s'
```

StateT

```
newtype StateT s m a =
  StateT { runStateT :: (s -> m (a,s)) }

instance (Monad m) => Monad (StateT s m) where
  return a      = StateT $ \s -> return (a,s)
  (StateT x) >>= f = StateT $ \s -> do
    (v,s') <- x s      -- get new value and state
    runStateT (f v) s' -- pass them to f
```

Our definition of `return` makes use of the `return` function of the base monad. (`>>=`) uses a `do`-block to perform a computation in the base monad.

⁶ Chapter 35 on page 219

Note:

Incidentally, we can now finally explain why, back in the chapter about `State`^a, there was a `state` function instead of a `State` constructor. In the `transformers` and `mtl` packages, `State s` is implemented as a type synonym for `StateT s Identity`, with `Identity` being the dummy monad introduced in an exercise of the previous section. The resulting monad is equivalent to the one defined using `newtype` that we have used up to now.

^a Chapter 35.2.1 on page 224

If the combined monads `StateT s m` are to be used as state monads, we will certainly want the all-important `get` and `put` operations. Here, we will show definitions in the style of the `mtl` package. In addition to the monad transformers themselves, `mtl` provides type classes for the essential operations of common monads. For instance, the `MonadState` class, found in `Control.Monad.State`⁷, has `get` and `put` as methods:

```
instance (Monad m) => MonadState s (StateT s m) where
  get  = StateT $ \s -> return (s,s)
  put s = StateT $ \_ -> return ((),s)
```

Note:

`instance (Monad m) => MonadState s (StateT s m)` should be read as: "For any type `s` and any instance of `Monad m`, `s` and `StateT s m` together form an instance of `MonadState`". `s` and `m` correspond to the state and the base monad, respectively. `s` is an independent part of the instance specification so that the methods can refer to it — for instance, the type of `put` is `s -> StateT s m ()`.

There are `MonadState` instances for state monads wrapped by other transformers, such as `MonadState s m => MonadState s (MaybeT m)`. They bring us extra convenience by making it unnecessary to lift uses of `get` and `put` explicitly, as the `MonadState` instance for the combined monads handles the lifting for us.

It can also be useful to lift instances that might be available for the base monad to the combined monad. For instance, all combined monads in which `StateT` is used with an instance of `MonadPlus` can be made instances of `MonadPlus`:

```
instance (MonadPlus m) => MonadPlus (StateT s m) where
  mzero = StateT $ \_ -> mzero
  (StateT x1) `mplus` (StateT x2) = StateT $ \s -> (x1 s) `mplus` (x2 s)
```

The implementations of `mzero` and `mplus` do the obvious thing; that is, delegating the actual work to the instance of the base monad.

Lest we forget, the monad transformer must have a `MonadTrans`, so that we can use `lift`:

```
instance MonadTrans (StateT s) where
  lift c = StateT $ \s -> c >>= (\x -> return (x,s))
```

⁷ <http://hackage.haskell.org/packages/archive/mtl/latest/doc/html/Control-Monad-State.html>

The `lift` function creates a `StateT` state transformation function that binds the computation in the base monad to a function that packages the result with the input state. If, for instance, we apply `StateT` to the `List` monad, a function that returns a list (i.e., a computation in the `List` monad) can be lifted into `StateT s []` where it becomes a function that returns a `StateT (s -> [(a,s)])`. I.e. the lifted computation produces *multiple* (value,state) pairs from its input state. This "forks" the computation in `StateT`, creating a different branch of the computation for each value in the list returned by the lifted function. Of course, applying `StateT` to a different monad will produce different semantics for the `lift` function.

Exercises:

1. Implement `state :: MonadState s m => (s -> (a, s)) -> m a` in terms of `get` and `put`.
2. Are `MaybeT (State s)` and `StateT s Maybe` equivalent? (Hint: one approach is comparing what the `run...T` unwrappers produce in each case.)

37.6 Acknowledgements

This module uses a number of excerpts from *All About Monads*⁸, with permission from its author Jeff Newbern.

[ru:Haskell/Monad transformers](http://ru.wikibooks.org/wiki/Haskell/Monad_transformers)⁹

⁸ http://www.haskell.org/haskellwiki/All_About_Monads

⁹ <https://ru.wikibooks.org/wiki/Haskell%2FMonad%20transformers>

38 Advanced Haskell

39 Monoids

In earlier parts of the book, we have made a few passing allusions to monoids and the `Monoid` type class (most notably when discussing `MonadPlus`¹). Here we'll give them a more detailed look and show what makes them useful.

39.1 What is a monoid?

The operation of adding numbers has a handful of properties which are so elementary we don't even think about them when summing numbers up. One of them is *associativity*: when adding three or more numbers it doesn't matter how we group the terms.

```
GHCi> (5 + 6) + 10
21
GHCi> 5 + (6 + 10)
21
```

Another one is that it has an *identity element*, which can be added to any other number without changing its value. That element is the number zero:

```
GHCi> 255 + 0
255
GHCi> 0 + 255
255
```

Addition is not the only binary operation which is associative and has an identity element. Multiplication does too, albeit with a different identity.

```
GHCi> (5 * 6) * 10
300
GHCi> 5 * (6 * 10)
300
GHCi> 255 * 1
255
GHCi> 1 * 255
255
```

We needn't restrict ourselves to arithmetic either. `(++)`, the appending operation for Haskell lists, is another example. It has the empty list as its identity element.

```
GHCi> ([1,2,3] ++ [4,5,6]) ++ [7,8,9]
[1,2,3,4,5,6,7,8,9]
GHCi> [1,2,3] ++ ([4,5,6] ++ [7,8,9])
[1,2,3,4,5,6,7,8,9]
GHCi> [1,2,3] ++ []
[1,2,3]
```

1 <https://en.wikibooks.org/wiki/Haskell%2FMonadPlus%23Relationship%20with%20monoids>

```
GHCi> [] ++ [1,2,3]
[1,2,3]
```

It turns out there are a great many associative binary operations with an identity. All of them, by definition, give us examples of *monoids*. We say, for instance, that the integer numbers form a monoid under addition with 0 as identity element.

39.2 The Monoid class

Monoids show up very often in Haskell, and so it is not surprising to find there is a type class for them in the core libraries. Here it is:

```
class Monoid a where
  mempty  :: a
  mappend :: a -> a -> a

  mconcat :: [a] -> a
  mconcat = foldr mappend mempty
```

The `mappend` method is the binary operation, and `mempty` is its identity. The third method, `mconcat`, is provided as a bonus; it runs down a list and `mappends` its elements together in order.

”mappend” is a somewhat long and unwieldy name for a binary function so general, even more so for one which is often used infix. Fortunately, `Data.Monoid`² `Data.Monoid` provides `(<>)`, a convenient operator synonym for `mappend`. In what follows, we will use `mappend` and `(<>)` interchangeably.

As an example, this is the monoid instance for lists:

```
instance Monoid [a] where
  mempty  = []
  mappend = (++)
```

Note that, in this case, `mconcat = foldr (++) []` is equivalent to `concat`, which explains the name of the method.

It is legitimate to think of monoids as types which support *appending* in some sense, though a dose of poetic licence is required. The `Monoid` definition is extremely general and not at all limited to data structures, so ”appending” will be just a metaphor at times.

As we suggested earlier on, numbers (i.e. instances of `Num`) form monoids under both addition and multiplication. That leads to the awkward question of which one to choose when writing the instance. In situations like this one, in which there is no good reason to choose one possibility over the other, the dilemma is averted by creating one `newtype` for each instance:

```
-- | Monoid under addition.
newtype Sum a = Sum { getSum :: a }

-- | Monoid under multiplication.
newtype Product a = Product { getProduct :: a }
```

² <http://hackage.haskell.org/packages/archive/base/latest/doc/html/Data-Monoid.html>

```
instance Num a => Monoid (Sum a) where
  mempty = Sum 0
  Sum x `mappend` Sum y = Sum (x + y)

instance Num a => Monoid (Product a) where
  mempty = Product 1
  Product x `mappend` Product y = Product (x * y)
```

Here is a quick demonstration of `Sum` and `Product`:

```
GHCi> import Data.Monoid
GHCi> Sum 5 <> Sum 6 <> Sum 10
Sum {getSum = 21}
GHCi> mconcat [Sum 5, Sum 6, Sum 10]
Sum {getSum = 21}
GHCi> getSum . mconcat . fmap Sum $ [5, 6, 10]
21
GHCi> getProduct . mconcat . fmap Product $ [5, 6, 10]
300
```

39.2.1 Monoid laws

The laws which all instances of `Monoid` must follow simply state the properties we already know: `mappend` is associative and `mempty` is its identity element.

```
(x <> y) <> z = x <> (y <> z) -- associativity
mempty <> x = x                 -- left identity
x <> mempty = x                 -- right identity
```

Exercises:

1. There are several possible monoid instances for `Bool`. Write at least two of them using `newtypes`, as in the `Sum` and `Product` examples. Be sure to verify the monoid laws hold for your instances ^a.

^a You will later find that two of those instances are defined in `Data.Monoid` already.

39.3 Uses

Which advantages are there in having a class with a pompous name for such a simple concept? As usual in such cases, the key gains are in two associated dimensions: recognisability and generality. Whenever, for instance, you see `(<>)` being used you know that, however the specific instance was defined, the operation being done is associative and has an identity element. Moreover, you also know that if there is an instance of `Monoid` for a type you can take advantage of functions written to deal with monoids in general. As a toy example of such a function, we might take this function that concatenates three lists..

```
threeConcat :: [a] -> [a] -> [a] -> [a]
threeConcat a b c = a ++ b ++ c
```

... and replace all `(++)` with `(<>)`...

```
mthreeConcat :: Monoid m => m -> m -> m -> m  
mthreeConcat a b c = a <> b <> c
```

... thus making it work with any `Monoid`. When used on other types the generalised function will behave in an analogous way to the original one, as specified by the monoid laws.

```
GHCi> mthreeConcat "Hello" " " "world!"  
"Hello world!"  
GHCi> mthreeConcat (Sum 5) (Sum 6) (Sum 10)  
Sum {getSum = 21}
```

Monoids are extremely common, and have many interesting practical applications.

The `Writer` monad

A computation of type `Writer w a` computes a value of type `a` while producing extra output of type `w` which must be an instance of `Monoid`, and the `bind` operator of the monad uses `mappend` to accumulate the extra output. A typical use case would be logging, in which each computation produces a log entry for later inspection. In the logging use case, that would mean all entries generated during a series of computations are automatically combined into a single log output.

The `Foldable` class

Monoids play an important role in generalising list-like folding to other data structures. We will study that in detail in the upcoming chapter about the `Foldable` class³.

Finger trees

Moving on from operations on data structures to data structure implementations, monoids can be used to implement *finger trees*, an efficient and versatile data structure. Its implementation makes use of monoidal values as tags for the tree nodes; and different data structures (such as sequences, priority queues, and search trees) can be obtained simply by changing the involved `Monoid` instance.⁴

Options and settings

In a wholly different context, monoids can be a handy way of treating application options and settings. Two examples are Cabal, the Haskell packaging system ("Package databases are monoids. Configuration files are monoids. Command line flags and sets of command line flags are monoids. Package build information is a monoid.") and XMonad⁵, a tiling window manager implemented in Haskell ("xmonad configuration hooks are monoidal.")⁶. Below are snippets from a XMonad configuration file (which is just a Haskell program) showing the monoidal hooks in action⁷.

3 Chapter 41 on page 275

4 This blog post ^{<http://apfelmus.nfshost.com/articles/monoid-fingertree.html>}, based on a paper by Ralf Hinze and Ross Patterson ^{<http://www.soi.city.ac.uk/~ross/papers/FingerTree.html>}, contains a brief and accessible explanation on how monoids are used in finger trees.

5 <http://xmonad.org>

6 Sources of the quotes (Haskell Cafe mailing list): <http://www.haskell.org/pipermail/haskell-cafe/2009-January/053602.html>, <http://www.haskell.org/pipermail/haskell-cafe/2009-January/053603.html>.

7 The snippets were taken from Ivy Foster's example config in the HaskellWiki ^{https://wiki.haskell.org/Xmonad/Config_archive/ivy-foster-xmonad.hs} and XMonad's `XMonad.ManageHook` ^{<http://www.haskell.org/xmonad/>}

```

-- A ManageHook is a rule, or a combination of rules, for
-- automatically handling specific kinds of windows. It
-- is applied on window creation.

myManageHook :: ManageHook
myManageHook = composeAll
  [ manageConkeror
  , manageDocs
  , manageEmacs
  , manageGimp
  , manageImages
  , manageTerm
  , manageTransient
  , manageVideo
  , manageWeb
  , myNSManageHook scratchpads
  ]

-- manageEmacs, for instance, makes a duplicate of an Emacs
-- window in workspace 3 and sets its opacity to 90%. It
-- looks like this:

-- liftX lifts a normal X action into a Query (as expected by -->)
-- idHook ensures the proper return type
manageEmacs :: ManageHook
manageEmacs =
  className =? "Emacs"
  --> (ask >>= doF . \w -> (copyWindow w "3:emacs"))
  <+> (ask >>= \w -> liftX (setOpacity w 0.9) >> idHook)

-- The hooks are used as fields of the XMonad configuration,
-- which is passed to the IO action that starts XMonad.

myConfig xmproc = defaultConfig
  { -- Among other fields...
    , manageHook      = myManageHook
  }

-- idHook, (<+>), composeAll and (-->) are just user-friendly
-- synonyms for monoid operations, defined in the
-- XMonad.ManageHook module thusly:

-- | The identity hook that returns the WindowSet unchanged.
idHook :: Monoid m => m
idHook = mempty

-- | Infix 'mappend'. Compose two 'ManageHook' from right to left.
(<+>) :: Monoid m => m -> m -> m
(<+>) = mappend

-- | Compose the list of 'ManageHook's.
composeAll :: Monoid m => [m] -> m
composeAll = mconcat

-- | @p --> x@. If @p@ returns 'True', execute the 'ManageHook'.
--
-- > (-->) :: Monoid m => Query Bool -> Query m -> Query m -- a simpler type
(-->) :: (Monad m, Monoid a) => m Bool -> m a -> m a
p --> f = p >>= \b -> if b then f else return mempty

```

```

//hackage.haskell.org/packages/archive/xmonad/0.11/doc/html/XMonad-ManageHook.html}
module as of version 0.11.

```

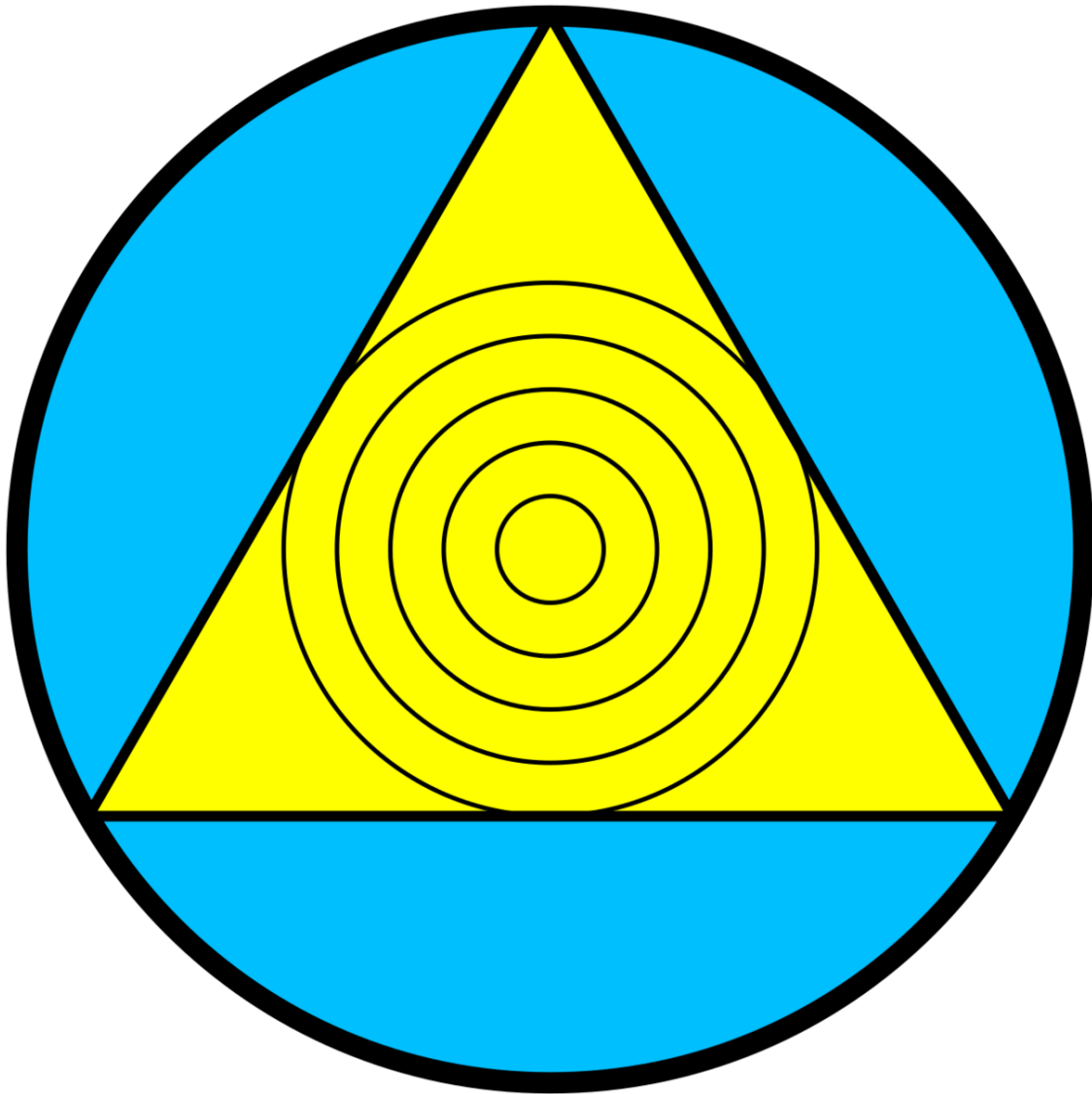

Figure 5 A simple diagrams example. The code for it is:

```
mconcat (fmap
  (circle . (/20)) [1..5])
<> triangle (sqrt 3 / 2)
  lwL 0.01 fc yellow
<> circle 0.5 lwL 0.02
  fc deepskyblue
```

diagrams

The `diagrams`⁸ package provides a powerful library for generating vectorial images programmatically. On a basic level, (`<>`) appears often in code using `diagrams` because squares, rectangles and other such graphic elements have `Monoid` instances which are used to put

⁸ <http://projects.haskell.org/diagrams>

them on the top of each other. On a deeper level, most operations with graphic elements are internally defined in terms of monoids, and the implementation takes full advantage of their mathematical properties.

39.4 Homomorphisms

A function `f :: a -> b` between two monoids `a` and `b` is called a **monoid homomorphism** if it preserves the monoid structure, so that:

```
f mempty          = mempty
f (x `mappend` y) = f x `mappend` f y
```

For instance, `length` is a homomorphism between $([],++)$ and $(0,+)$

```
length []          = 0
length (xs ++ ys) = length xs + length ys
```

An interesting example "in the wild" of monoids and homomorphisms was identified by Chris Kuklewicz amidst the Google Protocol Buffers API documentation⁹ Based on the quotes provided in the referenced comment, we highlight that the property that (in C++)...

```
MyMessage message;
message.ParseFromString(str1 + str2);
```

... is equivalent to...

```
MyMessage message, message2;
message.ParseFromString(str1);
message2.ParseFromString(str2);
message.MergeFrom(message2);
```

... means that `ParseFromString` is a monoid homomorphism. In a hypothetical Haskell implementation, the following equations would hold:

```
parse :: String -> Message
-- these are just equations, not actual code.
parse []          = mempty
parse (xs ++ ys) = parse xs `mergeFrom` parse ys
```

(They wouldn't hold *perfectly*, as parsing might fail, but roughly so.)

Recognising a homomorphism can lead to useful refactorings. For instance, if `mergeFrom` turned out to be an expensive operation it might be advantageous in terms of performance to concatenate the strings before parsing them. `parse` being a monoid homomorphism would then guarantee the same results would be obtained.

⁹ Source (Haskell Cafe): <http://www.haskell.org/pipermail/haskell-cafe/2009-January/053709.html>

39.5 Further reading

- Dan Piponi (Sigfpe) on monoids: a blog post overview¹⁰; a comment about intuition on associativity¹¹.
- Many monoid related links¹²
- Additional comment on finger trees (Haskell Cafe): FingerTrees¹³.
- Additional comments on Monoid usage in Cabal (Haskell Cafe): <http://www.haskell.org/pipermail/haskell-cafe/2009-January/053626.html>; <http://www.haskell.org/pipermail/haskell-cafe/2009-January/053721.html>.
- On diagrams and monoids: *Monoids: Theme and Variations (Functional Pearl)*¹⁴, by Brent Yorgey.

10 <http://sigfpe.blogspot.com/2009/01/haskell-monoids-and-their-uses.html>

11 <http://www.haskell.org/pipermail/haskell-cafe/2009-January/053798.html>

12 http://groups.google.com/group/bahaskell/browse_thread/thread/4cf0164263e0fd6b/42b621f5a4da6019

13 <http://www.haskell.org/pipermail/haskell-cafe/2009-January/053689.html>

14 <http://dept.cs.williams.edu/~byorgey/publications.html>

40 Applicative functors

When covering the vital `Functor` and `Monad` type classes, we glossed over a third type class: `Applicative`, the class for *applicative functors*. Like monads, applicative functors are functors with extra laws and operations; in fact, `Applicative` is an intermediate class between `Functor` and `Monad`. `Applicative` is a widely used class with a wealth of applications. It enables the eponymous *applicative style*, a convenient way of structuring functorial computations, and also provides means to express a number of important patterns.

40.1 Functor recap

We will begin with a quick review of the `Functor` class¹ chapter. `Functor` is characterised by the `fmap` function:

```
class Functor f where
  fmap :: (a -> b) -> f a -> f b
```

If a type is an instance of `Functor`, you can use `fmap` to apply a function to values in it. Another way of describing `fmap` is saying that it promotes functions to act on functorial values. To ensure `fmap` works sanely, any instance of `Functor` must comply with the following two laws:

```
fmap id = id                -- 1st functor law
fmap (g . f) = fmap g . fmap f -- 2nd functor law
```

Maybe, for example, has a `Functor` instance, and so we can easily modify the value inside it...

```
Prelude> fmap negate (Just 2)
Just (-2)
```

...as long as it exists, of course.

```
Prelude> fmap negate Nothing
Nothing
```

`fmap` has an infix synonym, `<$>`. It often helps readability, and also suggests how `fmap` can be seen as a different kind of function application.

```
Prelude> negate <$> Just 2
Just (-2)
```

¹ Chapter 27 on page 173

Exercises:

Define instances of `Functor` for the following types:

1. A rose tree, defined as: `data Tree a = Node a [Tree a]`
2. `Either e` for a fixed `e`.
3. The function type `((->) r)`. In this case, `f a` will be `(r -> a)`

40.2 Application in functors

As useful as it is, `fmap` isn't much help if we want to apply a function of two arguments to functorial values. For instance, how could we sum `Just 2` and `Just 3`? The brute force approach would be extracting the values from the `Maybe` wrapper. That, however, would mean having to do tedious checks for `Nothing`. Even worse: in a different `Functor` extracting the value might not even be an option (just think about `IO`).

We could use `fmap` to partially apply `(+)` to the first argument:

```
Prelude> :t (+) <$> Just 2
(+ <$> Just 2 :: Num a => Maybe (a -> a)
```

But now we are stuck: we have a function and a value both wrapped in `Maybe`, and no way of applying one to the other. The closest we can get to the desired `Just 5` is probably this:

```
Prelude> (<$> Just 3) (<$> (+) <$> Just 2
Just (Just 5)
```

(note that `(+) <$> Just 2` is `Just (2+)`).

What we would like to have is an operator with a type akin to `f (a -> b) -> f a -> f b` to apply functions in the context of a functor. If that operator was called `(<*>)`, we would be able to write:

```
(+) <$> Just 2 <*> Just 3
```

Lo and behold - that works!

```
Prelude> (+) <$> Just 2 <*> Just 3
Just 5
```

The type of `(<*>)` is:

```
Prelude> :t (<*>)
(<*>) :: Applicative f => f (a -> b) -> f a -> f b
```

`(<*>)` is one of the methods of `Applicative`, the type class of *applicative functors* - functors that support function application within their contexts. Expressions such as `(+) <$> Just 2 <*> Just 3` are said to be written in *applicative style*, which is as close as we can get to regular function application while working with a functor. If you pretend for a moment the `<$>`, `<*>` and `Just` aren't there, our example looks just like `(+) 2 3`.

40.3 The Applicative class

The definition of `Applicative` is:

```
class (Functor f) => Applicative f where
  pure  :: a -> f a
  (<*>) :: f (a -> b) -> f a -> f b
```

Beyond `<*>`, the class has a second method, `pure`, which brings arbitrary values into the functor. As an example, let's have a look at the `Maybe` instance:

```
instance Applicative Maybe where
  pure      = Just
  (Just f) <*> (Just x) = Just (f x)
  _        <*> _       = Nothing
```

It doesn't do anything surprising: `pure` wraps the value with `Just`; `<*>` applies the function to the value if both exist, and results in `Nothing` otherwise.

40.3.1 Applicative functor laws

Note:

For the lack of a better shorthand, in what follows we will use the jargony word *morphism* to refer to the values to the left of `<*>`, which fit the type `Applicative f => f (a -> b)`; that is, the function-like things inserted into an applicative functor. "Morphism" is a term which comes from category theory and which has a much wider meaning, but that needn't concern us now.

Just like `Functor`, `Applicative` has a set of laws which reasonable instances should follow. They are:

```
pure id <*> v = v                -- Identity
pure f <*> pure x = pure (f x)   -- Homomorphism
u <*> pure y = pure ($ y) <*> u   -- Interchange
pure (.) <*> u <*> v <*> w = u <*> (v <*> w) -- Composition
```

Those laws are a bit of a mouthful. They become easier to understand if you think of `pure` as a way to inject values into the functor in a default, featureless way, so that the result is as close as possible to the plain value. Thus:

- The identity law says that applying the `pure id` morphism does nothing, exactly like with the plain `id` function.
- The homomorphism law says that applying a "pure" function to a "pure" value is the same as applying the function to the value in the normal way and then using `pure` on the result. In a sense, that means `pure` preserves function application.
- The interchange law says that applying a morphism to a "pure" value `pure y` is the same as applying `pure ($ y)` to the morphism. No surprises there - as we have seen in the higher order functions chapter², `($ y)` is the function that supplies `y` as argument to another function.

² Chapter 19.4.3 on page 132

- The composition law says that `pure (.)` composes morphisms similarly to how `(.)` composes functions: applying the composed morphism `pure (.) <*> u <*> v` to `w` gives the same result as applying `u` to the result of applying `v` to `w`.³

There is also a bonus law about the relation between `fmap` and `<*>`:

```
fmap f x = pure f <*> x           -- fmap
```

Applying a "pure" function with `<*>` is equivalent to using `fmap`. This law is a consequence of the other ones, so you need not bother with proving it when writing instances of `Applicative`.

Exercises:

1. Check that the `Applicative` laws hold for this instance for `Maybe`
2. Write `Applicative` instances for
 - a. `Either e`, for a fixed `e`
 - b. `((->) r)`, for a fixed `r`

40.4 Déjà vu

Does `pure` remind you of anything?

```
pure :: Applicative f => a -> f a
```

The only difference between that and...

```
return :: Monad m => a -> m a
```

... is the class constraint. `pure` and `return` serve the same purpose; that is, bringing values into functors. The uncanny resemblances do not stop here. Back in the chapter about `State`⁴ we mentioned a function called `ap...`

```
ap :: (Monad m) => m (a -> b) -> m a -> m b
```

... which could be used to make functions with many arguments less painful to handle in monadic code:

```
allTypes :: GeneratorState (Int, Float, Char, Integer, Double, Bool, Int)
allTypes = liftM (,,,,,) getRandom
           `ap` getRandom
           `ap` getRandom
           `ap` getRandom
           `ap` getRandom
           `ap` getRandom
           `ap` getRandom
```

`ap` looks a lot like `<*>`.

Those, of course, are not coincidences. `Monad` inherits from `Applicative`...

³ The corresponding property for `(.)` and plain functions is `(u . v) w = u (v w)`.

⁴ Chapter 35 on page 219

```
Prelude> :info Monad
class Applicative m => Monad (m :: * -> *) where
--etc.
```

... because `return` and `(>>=)` are enough to implement `pure` and `(<*>)` ⁵.

```
pure = return
(<*>) = ap

ap u v = do
  f <- u
  x <- v
  return (f x)
```

Several other monadic functions have more general applicative versions. Here are a few of them:

Monadic	Applicative	Module (where to find the applicative version)
<code>(>>)</code>	<code>(*>)</code>	Prelude (GHC 7.10+); Control.Applicative ⁶
<code>liftM2</code>	<code>liftA2</code>	Control.Applicative ⁷
<code>mapM</code>	<code>traverse</code>	Prelude (GHC 7.10+); Data.Traversable ⁸
<code>sequence</code>	<code>sequenceA</code>	Data.Traversable ⁹
<code>forM_</code>	<code>for_</code>	Data.Foldable ¹⁰

Exercises:

- Write a definition of `(<*>)` using `(>>=)` and `fmap`. Do not use do-notation.
- Implement

```
liftA5 :: Applicative f => (a -> b -> c -> d -> e -> k)
-> f a -> f b -> f c -> f d -> f e -> f k
```

40.5 ZipList

Lists are applicative functors as well. Specialised to lists, the type of `(<*>)` becomes...

```
[a -> b] -> [a] -> [b]
```

... and so `(<*>)` applies a list of functions to another list. But exactly how is that done?

⁵ And if the `Monad` instance follows the monad laws, the resulting `pure` and `(<*>)` will automatically follow the applicative laws.

⁶ <http://hackage.haskell.org/packages/archive/base/latest/doc/html/Control-Applicative.html>

⁷ <http://hackage.haskell.org/packages/archive/base/latest/doc/html/Control-Applicative.html>

⁸ <http://hackage.haskell.org/packages/archive/base/latest/doc/html/Data-Traversable.html>

⁹ <http://hackage.haskell.org/packages/archive/base/latest/doc/html/Data-Traversable.html>

¹⁰ <http://hackage.haskell.org/packages/archive/base/latest/doc/html/Data-Foldable.html>

The standard instance of `Applicative` for lists, which follows from the `Monad` instance¹¹, applies every function to every element, like an explosive version of `map`.

```
Prelude> [(2*), (5*), (9*)] <*> [1,4,7]
[2,8,14,5,20,35,9,36,63]
```

Interestingly, there is another reasonable way of applying a list of functions. Instead of using every combination of functions and values, we can match each function with the value in the corresponding position in the other list. A `Prelude` function which can be used for that is `zipWith`:

```
Prelude> :t zipWith
zipWith :: (a -> b -> c) -> [a] -> [b] -> [c]
Prelude> zipWith ($) [(2*), (5*), (9*)] [1,4,7]
[2,20,63]
```

When there are two useful possible instances for a single type, the dilemma is averted by creating a `newtype` which implements one of them. In this case, we have `ZipList`, which lives in `Control.Applicative`¹²:

```
newtype ZipList a = ZipList { getZipList :: [a] }
```

We have already seen what `<*>` should be for zip-lists; all that is needed is to add the `newtype` wrappers:

```
instance Applicative ZipList where
  (ZipList fs) <*> (ZipList xs) = ZipList (zipWith ($) fs xs)
  pure x                       = undefined -- TODO
```

As for `pure`, it is tempting to use `pure x = ZipList [x]`, following the standard list instance. We can't do that, however, as it violates the applicative laws. According to the identity law:

```
pure id <*> v = v
```

Substituting `<*>` and the suggested `pure`, we get:

```
ZipList [id] <*> ZipList xs = ZipList xs
ZipList (zipWith ($) [id] xs) = ZipList xs
```

Now, suppose `xs` is the infinite list `[1..]`:

```
ZipList (zipWith ($) [id] [1..]) = ZipList [1..]
ZipList [1] = ZipList [1..]
[1] = [1..] -- Obviously false!
```

The problem is that `zipWith` produces lists whose length is that of the shortest list passed as argument, and so `(ZipList [id] <*>)` will cut off all elements of the other zip-list after the first. The only way to ensure `zipWith ($) fs` never removes elements is making `fs` infinite. The correct `pure` follows from that:

11 Chapter 32 on page 203

12 <http://hackage.haskell.org/packages/archive/base/latest/doc/html/Control.Applicative.html>

```
instance Applicative ZipList where
  (ZipList fs) <*> (ZipList xs) = ZipList (zipWith ($) fs xs)
  pure x                       = ZipList (repeat x)
```

The `ZipList` applicative instance offers an alternative to all the `zipN` and `zipWithN` functions in `Data.List`¹³ which can be extended to any number of arguments:

```
>>> import Control.Applicative
>>> ZipList [(2*), (5*), (9*)] <*> ZipList [1,4,7]
ZipList {getZipList = [2,20,63]}
>>> (,) <$> ZipList [1,4,9] <*> ZipList [2,8,1] <*> ZipList [0,0,9]
ZipList {getZipList = [(1,2,0), (4,8,0), (9,1,9)]}
>>> liftA3 (,) (ZipList [1,4,9]) (ZipList [2,8,1]) (ZipList [0,0,9])
ZipList {getZipList = [(1,2,0), (4,8,0), (9,1,9)]}
```

40.6 Sequencing of effects

As we have just seen, the standard `Applicative` instance for lists applies every function in one list to every element of the other. That, however, does not specify `<*>` unambiguously. To see why, try to guess what is the result of `[(2*), (3*)] <*> [4,5]` without looking at the example above or the answer just below.

```
Prelude> [(2*), (3*)] <*> [4,5]
```

```
--- ...
```

```
[8,10,12,15]
```

Unless you were paying very close attention or had already analysed the implementation of `<*>`, the odds of getting it right were about even. The other possibility would be `[8,12,10,15]`. The difference is that for the first (and correct) answer the result is obtained by taking the skeleton of the first list and replacing each element by all possible combinations with elements of the second list, while for the other possibility the starting point is the second list.

In more general terms, the difference between is one of *sequencing of effects*. Here, by effects we mean the functorial context, as opposed to the values within the functor (some examples: the skeleton of a list, actions performed in the real world in `IO`, the existence of a value in `Maybe`). The existence of two legal implementations of `<*>` for lists which only differ in the sequencing of effects indicates that `[]` is a non-commutative applicative functor. A *commutative* applicative functor, by contrast, leaves no margin for ambiguity in that respect. More formally, a commutative applicative functor is one for which the following holds:

```
liftA2 f u v = liftA2 (flip f) v u -- Commutativity
```

Or, equivalently,

```
f <$> u <*> v = flip f <$> v <*> u
```

¹³ <http://hackage.haskell.org/packages/archive/base/latest/doc/html/Data-List.html>

By the way, if you hear about *commutative monads* in Haskell, the concept involved is the same, only specialised to `Monad`.

Commutativity (or the lack thereof) affects other functions which are derived from `(<*>)` as well. `(>*)` is a clear example:

```
(>*) :: Applicative f => f a -> f b -> f b
```

`(>*)` combines effects while preserving only the values of its second argument. For monads, it is equivalent to `(>>)`. Here is a demonstration of it using `Maybe`, which is commutative:

```
Prelude> Just 2 *> Just 3
Just 3
Prelude> Just 3 *> Just 2
Just 2
Prelude> Just 2 *> Nothing
Nothing
Prelude> Nothing *> Just 2
Nothing
```

Swapping the arguments does not affect the effects (that is, the being and nothingness of wrapped values). For `IO`, however, swapping the arguments does reorder the effects:

```
Prelude> (print "foo" *> pure 2) *> (print "bar" *> pure 3)
"foo"
"bar"
3
Prelude> (print "bar" *> pure 3) *> (print "foo" *> pure 2)
"bar"
"foo"
2
```

The convention in Haskell is to always implement `(<*>)` and other applicative operators using left-to-right sequencing. Even though this convention helps reducing confusion, it also means appearances sometimes are misleading. For instance, the `(<*)` function is *not flip* `(>*)`, as it sequences effects from left to right just like `(>*)`:

```
Prelude> (print "foo" *> pure 2) <* (print "bar" *> pure 3)
"foo"
"bar"
2
```

For the same reason, `(<***>) :: Applicative f => f a -> f (a -> b) -> f b` from `Control.Applicative` is not `flip (<*>)`. That means it provides a way of inverting the sequencing:

```
>>> [(2*), (3*)] <*> [4,5]
[8,10,12,15]
>>> [4,5] <***> [(2*), (3*)]
[8,12,10,15]
```

An alternative is the `Control.Applicative.Backwards`¹⁴ module from `transformers`, which offers a newtype for flipping the order of effects:

¹⁴ <http://hackage.haskell.org/packages/archive/transformers/latest/doc/html/Control-Applicative-Backwards.html>

```
newtype Backwards f a = Backwards { forwards :: f a }
```

```
>>> Backwards [(2*), (3*)] <*> Backwards [4,5]
Backwards [8,12,10,15]
```

Exercises:

1. For the list functor, implement from scratch (that is, without using anything from `Applicative` or `Monad` directly) both `<*>` and its version with the "wrong" sequencing of effects, `<|*|>` :: `Applicative f => f (a -> b) -> f a -> f b`
2. Rewrite the definition of commutativity for a `Monad` using `do`-notation instead of `ap` or `liftM2`.
3. Are the following applicative functors commutative?
 - a. `ZipList`
 - b. `((->) r)`
 - c. `State s` (Use the `newtype` definition from the `State` chapter^a. Hint: You may find the answer to exercise 2 of this block useful.)
4. What is the result of `[2,7,8] *> [3,9]`? (Try to guess without writing.)
5. Implement `<***>` in terms of other `Applicative` functions.
6. As we have just seen, some functors allow two legal implementations of `<*>` which are only different in the sequencing of effects. Why there is not an analogous issue involving `>=>`?

^a Chapter 35.2.1 on page 224

40.7 A sliding scale of power

`Functor`, `Applicative`, `Monad`. Three closely related functor type classes; three of the most important classes in Haskell. Though we have seen many examples of `Functor` and `Monad` in use, and a few of `Applicative`, we have not compared them head to head yet. If we ignore `pure/return` for a moment, the characteristic methods of the three classes are:

```
fmap :: Functor f => (a -> b) -> f a -> f b
(<*>) :: Applicative f => f (a -> b) -> f a -> f b
(>=>) :: Monad m => m a -> (a -> m b) -> m b
```

While those types look disparate, we can change the picture with a few cosmetic adjustments. Let's replace `fmap` by its infix synonym, `<$>`; `>=>` by its flipped version, `=<<`; and tidy up the signatures a bit:

```
<$> :: Functor t    => (a -> b) -> (t a -> t b)
<*> :: Applicative t => t (a -> b) -> (t a -> t b)
=<< :: Monad t      => (a -> t b) -> (t a -> t b)
```

Suddenly, the similarities are striking. `fmap`, `(<*>)` and `(=<<)` are all mapping functions over `Functors` ¹⁵. The differences between them are in what is being mapped over in each case:

- `fmap` maps arbitrary functions over functors.
- `(<*>)` maps `t (a -> b)` morphisms¹⁶ over (applicative) functors.
- `(=<<)` maps `a -> t b` functions over (monadic) functors.

The day-to-day differences in uses of `Functor`, `Applicative` and `Monad` follow from what the types of those three mapping functions allow you to do. As you move from `fmap` to `(<*>)` and then to `(>>=)`, you gain in power, versatility and control, at the cost of guarantees about the results. We will now slide along this scale. While doing so, we will use the contrasting terms *values* and *context* to refer to plain values within a functor and to whatever surrounds them, respectively.

The type of `fmap` ensures that it is impossible to use it to change the context, no matter which function it is given. In `(a -> b) -> t a -> t b`, the `(a -> b)` function has nothing to do with the `t` context of the `t a` functorial value, and so applying it cannot affect the context. For that reason, if you do `fmap f xs` on some list `xs` the number of elements of the list will never change.

```
Prelude> fmap (2*) [2,5,6]
[4,10,12]
```

That can be taken as a safety guarantee or as an unfortunate restriction, depending on what you intend. In any case, `(<*>)` is clearly able to change the context:

```
Prelude> [(2*), (3*)] <*> [2,5,6]
[4,10,12,6,15,18]
```

The `t (a -> b)` morphism carries a context of its own, which is combined with that of the `t a` functorial value. `(<*>)`, however, is subject to a more subtle restriction. While `t (a -> b)` morphisms carry context, within them there are plain `(a -> b)`, which are still unable to modify the context. That means the changes to the context `(<*>)` performs are fully determined by the context of its arguments, and the values have no influence over the resulting context.

```
Prelude> (print "foo" *> pure (2*)) <*> (print "bar" *> pure 3)
"foo"
"bar"
6
Prelude> (print "foo" *> pure 2) *> (print "bar" *> pure 3)
"foo"
"bar"
3
Prelude> (print "foo" *> pure undefined) *> (print "bar" *> pure 3)
"foo"
"bar"
3
```

15 It is not just a question of type signatures resembling each other: the similarity has theoretical ballast. One aspect of the connection is that it is no coincidence that all three type classes have identity and composition laws.

16 Chapter 40.3.1 on page 263

Thus with `list (<*>)` you know that the length of the resulting list will be the product of the lengths of the original lists, with `IO (<*>)` you know that all real world effect will happen as long as the evaluation terminates, and so forth.

With `Monad`, however, we are in a very different game. `(>>=)` takes a `a -> t b` function, and so it is able to create context from values. That means a lot of flexibility:

```
Prelude> [1,2,5] >>= \x -> replicate x x
[1,2,2,5,5,5,5,5]
Prelude> [0,0,0] >>= \x -> replicate x x
[]
Prelude> return 3 >>= \x -> print $ if x < 10 then "Too small" else "OK"
"Too small"
Prelude> return 42 >>= \x -> print $ if x < 10 then "Too small" else "OK"
"OK"
```

Taking advantage of the extra flexibility, however, might mean having less guarantees about, for instance, whether your functions are able to unexpectedly erase parts of a data structure for pathological inputs, or whether the control flow in your application remains intelligible. In some situations there might be performance implications as well, as the complex data dependencies monadic code makes possible might prevent useful refactorings and optimisations. All in all, it is a good idea to only use as much power as needed for the task at hand. If you do need the extra capabilities of `Monad`, go right ahead; however, it is often worth it to check whether `Applicative` or `Functor` are sufficient.

Exercises:

The next few exercises concern the following tree data structure:

```
data AT a = L a | B (AT a) (AT a)
```

1. Write `Functor`, `Applicative` and `Monad` instances for `AT`. Do not use shortcuts such as `pure = return`. The `Applicative` and `Monad` instances should match; in particular, `(<*>)` should be equivalent to `ap`, which follows from the `Monad` instance.
2. Implement the following functions, using either the `Applicative` instance, the `Monad` one or neither of them, if neither is enough to provide a solution. Between `Applicative` and `Monad`, choose the *least* powerful one which is still good enough for the task. Justify your choice for each case in a few words.
 - a. `fructify :: AT a -> AT a`, which grows the tree by replacing each leaf `L` with a branch `B` containing two copies of the leaf.
 - b. `prune :: a -> (a -> Bool) -> AT a -> AT a`, with `prune z p t` replacing a branch of `t` with a leaf carrying the default value `z` whenever any of the leaves directly on it satisfies the test `p`.
 - c. `reproduce :: (a -> b) -> (a -> b) -> AT a -> AT b`, with `reproduce f g t` resulting in a new tree with two modified copies of `t` on the root branch. The left copy is obtained by applying `f` to the values in `t`, and the same goes for `g` and the right copy.
3. There is another legal instance of `Applicative` for `AT` (the reversed sequencing version of the original one doesn't count). Write it. Hint: this other instance can be used to implement

```
sagittalMap :: (a -> b) -> (a -> b) -> AT a -> AT b
```

 which, when given a branch, maps one function over the left child tree and the other over the right child tree. (In case you are wondering, "AT" stands for "apple tree". Botanist readers, please forgive the weak metaphors.)

40.8 The monoidal presentation

Back in Understanding monads¹⁷, we saw how the `Monad` class can be specified using either `(>=>)` or `join` instead of `(>>=)`. In a similar way, `Applicative` also has an alternative presentation, which might be implemented through the following type class:

```
class Functor f => Monoidal f where
  unit  :: f ()
  (*&*) :: f a -> f b -> f (a,b)
```

There are deep theoretical reasons behind the name "monoidal"¹⁸. In any case, we can informally say that it does look a lot like a monoid: `unit` provides a default functorial value whose context wraps nothing of interest, and `(*&*)` combines functorial values by pairing values and combining effects. The `Monoidal` formulation provides a clearer view of

¹⁷ Chapter 30.3.2 on page 195

¹⁸ For extra details, follow the leads from the corresponding section of the Typeclassopedia [^]{https://wiki.haskell.org/Typeclassopedia#Alternative_formulation} and the blog post by Edward Z. Yang which inspired it [^]{<http://blog.ezyang.com/2012/08/applicative-functors/>} .

how `Applicative` manipulates functorial contexts. Naturally, `unit` and `(*&*)` can be used to define `pure` and `(<*>)`, and vice-versa.

The `Applicative` laws are equivalent to the following set of laws, stated in terms of `Monoidal`:

```
fmap snd $ unit *&* v = v           -- Left identity
fmap fst $ u *&* unit = u          -- Right identity
fmap asl $ u *&* (v *&* w) = (u *&* v) *&* w -- Associativity
-- asl (x, (y, z)) = ((x, y), z)
```

The functions to the left of the (\$) are just boilerplate to convert between equivalent types, such as `b` and `(((), b))`. If you ignore them, the laws are a lot less opaque than in the usual `Applicative` formulation. By the way, just like for `Applicative` there is a bonus law, which is guaranteed to hold in Haskell:

```
fmap (g *** h) (u *&* v) = fmap g u *&* fmap h v -- Naturality
-- g *** h = \ (x, y) -> (g x, h y)
```

Exercises:

1. Write implementations for `unit` and `(*&*)` in terms of `pure` and `(<*>)`, and vice-versa.
2. Formulate the law of commutative applicative functors (see the Sequencing of effects^a section) in terms of the `Monoidal` methods.
3. Write from scratch `Monoidal` instances for:
 - a. `ZipList`
 - b. `((->) r)`

^a Chapter 40.6 on page 267

41 Foldable

The `Foldable` type class provides a generalisation of list folding (`foldr` and friends) and operations derived from it to arbitrary data structures. Besides being extremely useful, `Foldable` is a great example of how monoids can help formulating good abstractions.

41.1 Deconstructing `foldr`

`foldr` is quite a busy function — two binary functions on each side of the first function arrow, with types which use two variables each.

```
foldr :: (a -> b -> b) -> b -> [a] -> b
```

If we are going to generalise `foldr`, it would be convenient to have something simpler to work with, or at least to be able to break it down into simpler components. What could those components be?

A rough description of list folding would be that it consists of running through the list elements and combining them with a binary function. We happen to know one type class which is all about combining pairs of values: `Monoid`. If we take `foldr f z ...`

```
a `f` (b `f` (c `f` z)) -- foldr f z [a,b,c]
```

... and make `f = (<>)` and `z = mempty` ...

```
a <> (b <> (c <> mempty)) -- foldr (<>) mempty [a,b,c]
```

... we get `mconcat = foldr mappend mempty`, which is a simpler, specialised `foldr` in which we do not need to specify the combining function nor initial accumulator, as we simply use `mappend` (i.e. `<>`) and `mempty`:

```
mconcat :: Monoid m => [m] -> m
```

`mconcat` captures the combine-all-elements aspect of `foldr` well enough, and covers a few of its use cases:

```
GHCi> mconcat ["Tree", "fingers"] -- concat
"Treefingers"
```

Neat — but surely we don't want to be restricted to folding with `Monoid` instances only. One way to improve the situation a bit is by realising we can use `mconcat` to fold a list with elements of any type, as long as we have a function to convert them to some `Monoid` type:

```
foldMap :: Monoid m => (a -> m) -> [a] -> m
foldMap g = mconcat . fmap g
```

That makes things more interesting already:

```
GHCi> foldMap Sum [1..10]
Sum {getSum = 55}
```

So far so good, but it seems that we are still unable to fold with arbitrary combining functions. It turns out, however, that *any* binary function that fits the `foldr` signature can be used to convert values to a `Monoid` type! The trick is looking at the combining function passed to `foldr` as a function of one argument...

```
foldr :: (a -> (b -> b)) -> b -> [a] -> b
```

... and taking advantage of the fact that `b -> b` functions form a monoid under composition, with `(.)` as `mappend` and `id` as `mempty`¹. The corresponding `Monoid` instance is available through the `Endo` wrapper from `Data.Monoid`²:

```
newtype Endo b = Endo { appEndo :: b -> b }

instance Monoid Endo where
  mempty      = Endo id
  Endo g `mappend` Endo f = Endo (g . f)
```

We can now define...

```
foldComposing :: (a -> (b -> b)) -> [a] -> Endo b
foldComposing f = foldMap (Endo . f)
```

... which makes a `b -> b` function out of each element and composes them all:

```
Endo (f a) <> (Endo (f b) <> (Endo (f c) <> (Endo id))) -- foldComposing f
[a,b,c]
Endo (f a . (f b . (f c . id)))
-- (<>) and (.) are associative, so we don't actually need the parentheses.

-- As an example, here is a step-by-step evaluation:
foldComposing (+) [1, 2, 3]
foldMap (Endo . (+)) [1, 2, 3]
mconcat (fmap (Endo . (+)) [1, 2, 3])
mconcat (fmap Endo [(+1), (+2), (+3)])
mconcat [Endo (+1), Endo (+2), Endo (+3)]
Endo ((+1) . (+2) . (+3))
Endo (+6)
```

If we apply that function to some `b` value...

```
foldr :: (a -> (b -> b)) -> b -> [a] -> b
foldr f z xs = appEndo (foldComposing f xs) z
```

...we finally recover `foldr`. That means we can define `foldr` in terms of `foldMap`, a function which is much simpler and therefore easier to reason about. For that reason, `foldMap` is the conceptual heart of `Foldable`, the class which generalises `foldr` to arbitrary data structures.

¹ This trick will probably ring familiar if you did the exercise about `foldl` at the end of Higher order functions ^{Chapter19.4.5 on page 134}.

² "Endo" is shorthand for "endomorphism", a jargony word for functions from one type to the same type.

Exercises:

1. Write two implementations of `foldMap` for lists: one in terms of `foldr` and the other using recursion explicitly.

41.2 The Foldable class

Implementing `Foldable` for a data structure requires writing just one function: either `foldMap` or `foldr`. `Foldable`, however, has a lot of other methods:

```
-- Abridged definition, with just the method signatures.
class Foldable t where
  foldMap :: Monoid m => (a -> m) -> t a -> m
  foldr   :: (a -> b -> b) -> b -> t a -> b

  -- All of the following have default implementations:
  fold    :: Monoid m => t m -> m -- generalised mconcat
  foldr'  :: (a -> b -> b) -> b -> t a -> b
  foldl   :: (b -> a -> b) -> b -> t a -> b
  foldl'  :: (b -> a -> b) -> b -> t a -> b
  foldr1  :: (a -> a -> a) -> t a -> a
  foldl1  :: (a -> a -> a) -> t a -> a
  toList  :: t a -> [a]
  null    :: t a -> Bool
  length  :: t a -> Int
  elem    :: Eq a => a -> t a -> Bool
  maximum :: Ord a => t a -> a
  minimum :: Ord a => t a -> a
  sum     :: Num a => t a -> a
  product :: Num a => t a -> a
```

The extra methods are there so that more efficient implementations can be written if necessary. In any case, writing just `foldMap` or `foldr` gives you all of the very useful functions listed above for free. And it gets even better: `Data.Foldable`³ provides still more functions generalised to any `Foldable`, including, remarkably, `mapM_/traverse_`.

Here is a quick demonstration of `Foldable` using `Data.Map`^{4 5}:

```
GHCi> import qualified Data.Map as M
GHCi> let testMap = M.fromList $ zip [0..]
  ["Yesterday", "I", "woke", "up", "sucking", "a", "lemon"]
GHCi> length testMap
7
GHCi> sum . fmap length $ testMap
29
GHCi> elem "lemon" testMap
True
GHCi> foldr1 (\x y -> x ++ (' ' : y)) testMap -- Be careful: foldr1 is partial!
"Yesterday I woke up sucking a lemon"
GHCi> import Data.Foldable
GHCi> traverse_ putStrLn testMap
```

3 <http://hackage.haskell.org/packages/archive/base/latest/doc/html/Data-Foldable.html>

4 <http://hackage.haskell.org/packages/archive/containers/latest/doc/html/Data-Map.html>

5 For more information on `Data.Map` and other useful data structure implementations with, see the data structures primer `{https://en.wikibooks.org/wiki/Haskell%2FLibraries%2FData%20structures%20primer}`.

Yesterday
 I
 woke
 up
 sucking
 a
 lemon

Beyond providing useful generalisations, `Foldable` and `foldMap` suggest a more declarative way of thinking about folds. For instance, instead of describing `sum` as a function which runs across a list (or tree, or whatever the data structure is) accumulating its elements with (+), we might say that it *queries* each element for its value and *summarises* the results of the queries using the `Sum` monoid. Though the difference may seem small, the monoidal summary perspective can help clarifying problems involving folds by separating the core issue of what sort of result we wish to obtain from the details of the data structure being folded.

Exercises:

1. Let's play Spot The Monoid! Here are the rules: For each function, suggest a combination of `mempty`, `mappend` and, if necessary, a function to prepare the values that would allow it to be implemented with `fold` or `foldMap`. No need to bother with `newtype` instances (unless you want to test your solutions with `foldMap`, of course) – for example, "mempty is 0 and mappend is (+)" would be a perfectly acceptable answer for `sum`. If necessary, you can partially apply the functions and use the supplied arguments in the answers. Do not answer every question with `id` and `(.)` - that would be cheating! (Hint: if you need suggestions, have a look at the `Monoid` instances in `Data.Monoid`^a.)
 - a) `product :: (Foldable t, Num a) => t a -> a`
 - b) `concat :: Foldable t => t [a] -> [a]`
 - c) `concatMap :: Foldable t => (a -> [b]) -> t a -> [b]`
 - d) `all :: Foldable t => (a -> Bool) -> t a -> Bool`
 - e) `elem :: Eq a => a -> t a -> Bool`
 - f) `length :: t a -> Int`
 - g) `traverse_ :: (Foldable t, Applicative f) => (a -> f b) -> t a -> f ()`
 - h) `mapM_ :: (Foldable t, Monad m) => (a -> m b) -> t a -> m ()`
 - i) `safeMaximum :: Ord a => t a -> Maybe a`
(like `maximum`, but handling emptiness.)
 - j) `find :: Foldable t => (a -> Bool) -> t a -> Maybe a`
 - k) `composeL :: Foldable t => (b -> a -> b) -> t a -> b -> b`
(equivalent to `foldl`.)

^a <http://hackage.haskell.org/packages/archive/base/latest/doc/html/Data-Monoid.html>

41.3 List-like folding

`Foldable` includes the `toList :: Foldable t => t a -> [a]` method. That means any `Foldable` data structure can be turned into a list; moreover, folding the resulting list will produce the same results than folding the original structure directly. A possible `toList` implementation in terms of `foldMap` would be ⁶:

```
toList = foldMap (\x -> [x])
```

`toList` reflects the fact that lists are the **free monoid** for Haskell types. "Free" here means any value can be promoted to the monoid in a way which neither adds nor erases any information (we can convert values of type `a` to `[a]` lists with a single element and back through `(\x->[x])` and `head` in a lossless way) ⁷.

A related key trait of `Foldable` is made obvious by `toList`. Since `toList = id` for lists, if you are given a function defined as...

```
-- Given a list xs :: [a]
xsAsFoldMap :: Monoid m => (a -> m) -> m
xsAsFoldMap = \f -> foldMap f xs
```

... it is always possible to recover the original list `xs` by supplying `(\x->[x])` to `xsAsFoldMap`. In this sense, *lists are equivalent to their right folds*. That implies folding with the `Foldable` operations will unavoidably be a lossy operation if the data structure is more complex than a list. Putting it in another way, we can say that the list-like folds offered by `Foldable` are less general than folds of the sort we have seen back in Other data structures⁸ (formally known as *catamorphisms*), which do make it possible to reconstruct the original structure.

Exercises:

1. This exercise concerns the tree type we used in Other data structures^a: `data Tree a = Leaf a | Branch (Tree a) (Tree a)`
 - a) Write a `Foldable` instance for `Tree`.
 - b) Implement `treeDepth :: Tree a -> Int`, which gives the number of branches from the root of the tree to the furthest leaf. Use either the `Foldable` or the `treeFold` catamorphism defined in Other data structures^b. Are both suggestions actually possible?

^a Chapter 25.1 on page 155

^b Chapter 25.1.2 on page 157

⁶ `Data.Foldable` uses a different default implementation for performance reasons.

⁷ There is one caveat relating to non-termination with regards to saying lists form a free monoid. For details, see the *Free Monoids in Haskell* [^]<http://comonad.com/reader/2015/free-monoids-in-haskell> post by Dan Doel. (Note that the discussion there is quite advanced. You might not enjoy it much right now if you have just been introduced to `Foldable`.)

⁸ Chapter 25 on page 155

41.4 More facts about Foldable

`Foldable` is slightly unusual among Haskell classes which are both principled and general-purpose in that it has no laws of its own. The closest thing is the following property, which strictly speaking is not a law (as it is guaranteed to hold whatever the instance is): given a monoid homomorphism⁹ `g`,

```
foldMap (g . f) = g . foldMap f
```

Switching from `foldMap (g . f)` to `g . foldMap f` can be advantageous, as it means applying `g` only to the result of the fold, rather than to the potentially many elements in the structure being folded.

If the `Foldable` structure is a `Functor` as well, it also automatically holds that...

```
foldMap f = fold . fmap f
```

... and thus we get, after applying the second functor law¹⁰ and the property just above:

```
foldMap g . fmap f = foldMap (g . f) = g . foldMap f
```

Though the presence of a method such as `foldMap` might suggest that any `Foldable` types should have `Functor` instances as well, `Functor` is not actually a superclass of `Foldable`. That makes it possible to give `Foldable` instances to structures that, for whatever reason, cannot be `Functors`. The most common example are the sets¹¹ from `Data.Set`¹². Element types for those sets must be instances of `Ord`, and therefore their `map` function cannot be used as `fmap`, which has no additional class constraints. That, however, does not deny `Data.Set.Set` an useful `Foldable` instance.

```
GHCi> import qualified Data.Set as S
GHCi> let testSet = S.fromList [1,3,2,5,5,0]
GHCi> testSet
fromList [0,1,2,3,5]
GHCi> import Data.Foldable
GHCi> toList testSet
[0,1,2,3,5]
GHCi> foldMap show testSet
"01235"
```

9 Chapter 39.4 on page 259

10 Chapter 27.2.1 on page 174

11 <https://en.wikibooks.org/wiki/Haskell%2FLibraries%2FData%20structures%20primer%23Variations>

12 <http://hackage.haskell.org/packages/archive/containers/latest/doc/html/Data-Set.html>

Exercises:

1. a) Write the monoid instance for pairs,

```
(Monoid a, Monoid b) => Monoid (a,b)
```

- b) Prove that `fst` and `snd` are monoid homomorphisms.

- c) Use the monoid homomorphism property of `foldMap` presented above to prove that

```
foldMap f &&& foldMap g = foldMap (f &&& g)
where
```

```
f &&& g = \x -> (f x, g x)
```

This exercise is based on a message by Edward Kmett ^a.

^a Source (Haskell Café): <https://mail.haskell.org/pipermail/haskell-cafe/2015-February/118152.html>

42 Traversable

We already have studied four of the five type classes in the Prelude that can be used for data structure manipulation: `Functor`, `Applicative`, `Monad` and `Foldable`. The fifth one is `Traversable`¹. To traverse means to walk across, and that is exactly what `Traversable` generalises: walking across a structure, collecting results at each stop.

42.1 Functors made for walking

If traversing means walking across, though, we have been performing traversals for a long time already. Consider the following plausible `Functor` and `Foldable` instances for lists:

```
instance Functor [] where
    fmap _ [] = []
    fmap f (x:xs) = f x : fmap f xs

instance Foldable [] where
    foldMap _ [] = mempty
    foldMap f (x:xs) = f x <> foldMap f xs
```

`fmap f` walks across the list, applies `f` to each element and collects the results by rebuilding the list. Similarly, `foldMap f` walks across the list, applies `f` to each element and collects the results by combining them with `mappend`. `Functor` and `Foldable`, however, are not enough to express all useful ways of traversing. For instance, suppose we have the following `Maybe`-encoded test for negative numbers...

```
deleteIfNegative :: (Num a, Ord a) => a -> Maybe a
deleteIfNegative x = if x < 0 then Nothing else Just x
```

... and we want to use it to implement...

```
rejectWithNegatives :: (Num a, Ord a) => [a] -> Maybe [a]
```

... which gives back the original list wrapped in `Just` if there are no negative elements in it, and `Nothing` otherwise. Neither `Foldable` nor `Functor` on their own would help. Using `Foldable` would replace the structure of the original list with that of whatever `Monoid` we pick for folding, and there is no way of twisting that into giving either the original list or `Nothing`². As for `Functor`, `fmap` might be attractive at first...

1 Strictly speaking, we should refer to the five classes in the GHC Prelude, as `Applicative`, `Foldable` and `Traversable` aren't officially part of the Prelude yet according to the Haskell Report ^{<https://www.haskell.org/onlinereport/haskell2010>}. It is just a matter of time for them to be included, though.

2 One thing to attempt would be exploiting the `Monoid a => Monoid (Maybe a)` instance from `Data.Monoid` ^{<http://hackage.haskell.org/packages/archive/base/latest/doc/html/Data-Monoid.html>}. If you try that, however, you will see it can't possibly give the desired results.

```
GHCi> let testList = [-5,3,2,-1,0]
GHCi> fmap deleteIfNegative testList
[Nothing,Just 3,Just 2,Nothing,Just 0]
```

... but then we would need a way to turn a list of `Maybe` into `Maybe` a list. If you squint hard enough, that looks somewhat like a fold. Instead, however, of merely combining the values and destroying the list, we need to combine the `Maybe` contexts of the values and recreate the list structure within the combined context. Fortunately, there is a type class which is essentially about combining `Functor` contexts: `Applicative`³. `Applicative`, in turn, leads us to the class we need: `Traversable`.

```
instance Traversable [] where
  -- sequenceA :: Applicative f => [f a] -> f [a]
  sequenceA [] = pure []
  sequenceA (u:us) = (:) <$> u <*> sequenceA us

-- Or, equivalently:
instance Traversable [] where
  sequenceA us = foldr (\u v -> (:) <$> u <*> v) (pure []) us
```

`Traversable` is to `Applicative` contexts what `Foldable` is to `Monoid` values. From that point of view, `sequenceA` is analogous to `fold` — it creates an applicative summary of the contexts within a structure, and then rebuilds the structure in the new context. `sequenceA` is the function we were looking for:

```
GHCi> let rejectWithNegatives = sequenceA . fmap deleteIfNegative
GHCi> :t rejectWithNegatives
rejectWithNegatives
  :: (Num a, Ord a, Traversable t) => t a -> Maybe (t a)
GHCi> rejectWithNegatives testList
Nothing
GHCi> rejectWithNegatives [0..10]
Just [0,1,2,3,4,5,6,7,8,9,10]
```

These are the methods of `Traversable`:

```
class (Functor t, Foldable t) => Traversable t where
  traverse :: Applicative f => (a -> f b) -> t a -> f (t b)
  sequenceA :: Applicative f => t (f a) -> f (t a)

  -- These methods have default definitions.
  -- They are merely specialised versions of the other two.
  mapM :: Monad m => (a -> m b) -> t a -> m (t b)
  sequence :: Monad m => t (m a) -> m (t a)
```

If `sequenceA` is analogous to `fold`, `traverse` is analogous to `foldMap`. They can be defined in terms of each other, and therefore a minimal implementation of `Traversable` just needs to supply one of them:

```
traverse f = sequenceA . fmap f
sequenceA = traverse id
```

Rewriting the list instance using `traverse` makes the parallels with `Functor` and `Foldable` obvious:

3 The monoidal presentation [^]<https://en.wikibooks.org/wiki/Haskell%2FApplicative%20functors%20II%23The%20monoidal%20presentation> of `Applicative` makes that very clear.

```
instance Traversable [] where
  traverse _ [] = pure []
  traverse f (x:xs) = (:) <$> f x <*> traverse f xs

-- Or, equivalently:
instance Traversable [] where
  traverse f xs = foldr (\x v -> (:) <$> f x <*> v) (pure []) xs
```

In general, it is better to write `traverse` when implementing `Traversable`, as the default definition of `traverse` performs, in principle, two runs across the structure (one for `fmap` and another for `sequenceA`).

We can cleanly define `rejectWithNegatives` directly in terms of `traverse`:

```
rejectWithNegatives :: (Num a, Ord a, Traversable t) => t a -> Maybe (t a)
rejectWithNegatives = traverse deleteIfNegative
```

Exercises:

1. Give the `Tree` from Other data structures^a a `Traversable` instance. The definition of `Tree` is:

```
data Tree a = Leaf a | Branch (Tree a) (Tree a)
```

^a Chapter 25.1 on page 155

42.2 Interpretations of Traversable

`Traversable` structures can be walked over using the applicative functor of your choice. The type of `traverse`...

```
traverse :: (Applicative f, Traversable t) => (a -> f b) -> t a -> f (t b)
```

... resembles that of mapping functions we have seen in other classes. Rather than using its function argument to insert functorial contexts under the original structure (as might be done with `fmap`) or to modify the structure itself (as `(>>=)` does), `traverse` adds an extra layer of context *on the top* of the structure. Said in another way, `traverse` allows for *effectful traversals* — traversals which produce an overall effect (i.e. the new outer layer of context).

If the structure below the new layer is recoverable at all, it will match the original structure (the values might have changed, of course). Here is an example involving nested lists:

```
GHCi> traverse (\x -> [0..x]) [0..3]
[[0,0,0,0],[0,0,0,1],[0,0,0,2],[0,0,0,3],[0,0,1,0],[0,0,1,1]
,[0,0,1,2],[0,0,1,3],[0,0,2,0],[0,0,2,1],[0,0,2,2],[0,0,2,3]
,[0,1,0,0],[0,1,0,1],[0,1,0,2],[0,1,0,3],[0,1,1,0],[0,1,1,1]
,[0,1,1,2],[0,1,1,3],[0,1,2,0],[0,1,2,1],[0,1,2,2],[0,1,2,3]
]
```

The inner lists retain the structure the original list — all of them have four elements. The outer list is the new layer, corresponding to the introduction of nondeterminism through allowing each element to vary from zero to its (original) value.

We can also understand `Traversable` by focusing on `sequenceA` and how it *distributes* context.

```
GHCi> sequenceA [[1,2,3,4],[5,6,7]]
[[1,5],[1,6],[1,7],[2,5],[2,6],[2,7]
,[3,5],[3,6],[3,7],[4,5],[4,6],[4,7]
]
```

In this example, `sequenceA` can be seen distributing the old outer structure into the new outer structure, and so the new inner lists have two elements, just like the old outer list. The new outer structure is a list of twelve elements, which is exactly what you would expect from combining with (`<*>`) one list of four elements with another of three elements. One interesting aspect of the distribution perspective is how it helps making sense of why certain functors cannot possibly have instances of `Traversable` (how would one distribute an `IO` action? Or a function?).

Exercises:

Having the applicative functors^a chapter fresh in memory can help with the following exercises.

1. Consider a representation of matrices^b as nested lists, with the inner lists being the rows. Use `Traversable` to implement

```
transpose :: [[a]] -> [[a]]
```

which transposes a matrix (i.e. changes columns into rows and vice-versa). For the purposes of this exercise, we don't care about how fake "matrices" with rows of different sizes are handled.

2. Explain what `traverse mappend` does.
3. Time for a round of Spot The Applicative Functor. Consider:

```
mapAccumL :: Traversable t =>
    (a -> b -> (a, c)) -> a -> t b -> (a, t c)
```

Does its type remind you of anything? Use the appropriate `Applicative` to implement it with `Traversable`. As further guidance, here is the description of `mapAccumL` in the `Data.Traversable`^c documentation:

The `mapAccumL` function behaves like a combination of `fmap` and `fold`; it applies a function to each element of a structure, passing an accumulating parameter from left to right, and returning a final value of this accumulator together with the new structure.

^a Chapter 40 on page 261

^b <https://en.wikipedia.org/wiki/Matrix%20%28mathematics%29>

^c <http://hackage.haskell.org/packages/archive/base/latest/doc/html/Data-Traversable.html>

42.3 The Traversable laws

Sensible instances of `Traversable` have a set of laws to follow. There are the following two laws:

```
traverse Identity = Identity -- identity
traverse (Compose . fmap g . f) = Compose . fmap (traverse g) . traverse f --
composition
```

Plus a bonus law, which is guaranteed to hold:

```
-- If t is an applicative homomorphism, then
t . traverse f = traverse (t . f) -- naturality
```

Those laws are not exactly self-explanatory, so let's have a closer look at them. Starting from the last one: an applicative homomorphism is a function which preserves the `Applicative` operations, so that:

```
-- Given a choice of f and g, and for any a,
t :: (Applicative f, Applicative g) => f a -> g a

t (pure x) = pure x
t (x <*> y) = t x <*> t y
```

Note that not only this definition is analogous to the one of monoid homomorphisms⁴ which we have seen earlier on but also that the naturality law mirrors exactly the property about `foldMap` and monoid homomorphisms seen in the chapter about `Foldable`⁵.

The identity law involves `Identity`, the dummy functor:

```
newtype Identity a = Identity { runIdentity :: a }

instance Functor Identity where
  fmap f (Identity x) = Identity (f x)

instance Applicative Identity where
  pure x = Identity x
  Identity f <*> Identity x = Identity (f x)
```

The law says that all traversing with the `Identity` constructor does is wrap the structure with `Identity`, which amounts to doing nothing (as the original structure can be trivially recovered with `runIdentity`). The `Identity` constructor is thus the identity traversal, which is very reasonable indeed.

The composition law, in turn, is stated in terms of the `Compose` functor:

```
newtype Compose f g a = Compose { getCompose :: f (g a) }

instance (Functor f, Functor g) => Functor (Compose f g) where
  fmap f (Compose x) = Compose (fmap (fmap f) x)

instance (Applicative f, Applicative g) => Applicative (Compose f g) where
  pure x = Compose (pure (pure x))
  Compose f <*> Compose x = Compose ((<*>) <$> f <*> x)
```

`Compose` performs composition *of functors*. Composing two `Functors` results in a `Functor`, and composing two `Applicatives` results in an `Applicative`⁶. The instances are the obvious ones, threading the methods one further functorial layer down.

4 Chapter 39.4 on page 259

5 Chapter 42 on page 283

6 Remarkably, however, composing two `Monads` does not necessarily result in a `Monad`.

The composition law states that it doesn't matter whether we perform two traversals separately (right side of the equation) or compose them in order to walk across the structure only once (left side). It is analogous, for instance, to the second functor law. The `fmaps` are needed because the second traversal (or the second part of the traversal, for the left side of the equation) happens below the layer of structure added by the first (part). `Compose` is needed so that the composed traversal is applied to the correct layer.

`Identity` and `Compose` are available from `Data.Functor.Identity`⁷ and `Data.Functor.Compose`⁸ respectively.

The laws can also be formulated in terms of `sequenceA`:

```
sequenceA . fmap Identity = Identity -- identity
sequenceA . fmap Compose = Compose . fmap sequenceA . sequenceA -- composition
-- For any applicative homomorphism t:
t . sequenceA = sequenceA . fmap t -- naturality
```

Though it's not immediately obvious, several desirable characteristics of traversals follow from the laws, including⁹:

- Traversals do not skip elements.
- Traversals do not visit elements more than once.
- `traverse pure = pure`
- Traversals cannot modify the original structure (it is either preserved or fully destroyed).

42.4 Recovering `fmap` and `foldMap`

We still have not justified the `Functor` and `Foldable` class constraints of `Traversable`. The reason for them is very simple: as long as the `Traversable` instance follows the laws `traverse` is enough to implement both `fmap` and `foldMap`. For `fmap`, all we need is to use `Identity` to make a traversal out of an arbitrary function:

```
fmap f = runIdentity . traverse (Identity . f)
```

To recover `foldMap`, we need to introduce a third utility functor: `Const` from `Control.Applicative`¹⁰:

```
newtype Const a b = Const { getConst :: a }

instance Functor (Const a) where
  fmap _ (Const x) = Const x
```

`Const` is a *constant functor*. A value of type `Const a b` does not actually contain a `b` value. Rather, it holds an `a` value which is unaffected by `fmap`. For our current purposes, the truly interesting instance is the `Applicative` one

⁷ <http://hackage.haskell.org/packages/archive/base/latest/doc/html/Data-Functor-Identity.html>

⁸ <http://hackage.haskell.org/packages/archive/transformers/latest/doc/html/Data-Functor-Compose.html>

⁹ For technical details, check the papers cited by the `Data.Traversable` ^{<http://hackage.haskell.org/packages/archive/base/latest/doc/html/Data-Traversable.html>} documentation.

¹⁰ <http://hackage.haskell.org/packages/archive/base/latest/doc/html/Control.Applicative.html>

```
instance Monoid a => Applicative (Const a) where
  pure _ = Const mempty
  Const x <*> Const y = Const (x `mappend` y)
```

(`<*>`) simply combines the values in each context with `mappend`¹¹. We can exploit that to make a traversal out of any `Monoid m => a -> m` function that we might pass to `foldMap`. Thanks to the instance above, the traversal then becomes a fold:

```
foldMap f = getConst . traverse (Const . f)
```

We have just recovered from `traverse` two functions which on the surface appear to be entirely different, and all we had to do was pick two different functors. That is a taste of how powerful an abstraction functors are¹².

11 This is a great illustration of how `Applicative` combines contexts monoidally. If we remove the values within the context, the applicative laws in monoidal presentation ^{<https://en.wikibooks.org/wiki/Haskell%2FApplicative%20functors%20II%23The%20monoidal%20presentation>} match the monoid laws exactly.

12 A prime example, and one of clear practical relevance at that, is that great ode to functors, the lens ^{<https://hackage.haskell.org/package/lens>} library.

43 Arrow tutorial

Arrows provide an alternative to the usual way of structuring computations with the basic functor classes. This chapter provides a hands-on tutorial about them, while the next one, *Understanding arrows*¹, complements it with a conceptual overview. We recommend you to start with the tutorial, so that you get to taste what programming with arrows feels like. You can of course switch back and forth between the tutorial and the first part of *Understanding arrows* if you prefer going at a slower pace. Be sure to follow along every step of the tutorial on GHC(i).

43.1 Stephen's Arrow Tutorial

In this tutorial, I will create my own arrow, show how to use the arrow `proc` notation, and show how `ArrowChoice` works. We will end up with a simple game of Hangman.

First, we give a language pragma to enable the arrow `do` notation in the compiler:

```
{-# LANGUAGE Arrows #-}
```

And then, some imports:

```
module Main where

import Control.Arrow
import Control.Monad
import qualified Control.Category as Cat
import Data.List
import Data.Maybe
import System.Random
```

Any Haskell function can behave as an arrow, because there is an `Arrow` instance for the function type constructor `(->)`. In this tutorial I will build a more interesting arrow than this, with the ability to maintain state (something that a plain Haskell function arrow cannot do). Arrows can produce all sorts of effects, including I/O, but we'll just explore some simple examples.

We'll call our new arrow `Circuit` to suggest that we can visualize arrows as circuits.²

1 Chapter 44 on page 301

2 This interpretation of arrows-as-circuits is loosely based on the Yampa functional reactive programming library.

43.2 Type definition for Circuit

A plain Haskell function treated as an arrow has type `a -> b`. Our `Circuit` arrow has two distinguishing features: First, we wrap it in a `newtype` declaration to cleanly define an `Arrow` instance. Second, in order for the circuit to maintain its own internal state, our arrow returns a replacement for itself along with the normal `b` output value.

```
newtype Circuit a b = Circuit { unCircuit :: a -> (Circuit a b, b) }
```

To make this an arrow, we need to make it an instance of both `Category` and `Arrow`. Throughout these definitions, we always replace each `Circuit` with the new version of itself that it has returned.

```
instance Cat.Category Circuit where
  id = Circuit $ \a -> (Cat.id, a)
  (.) = dot
  where
    (Circuit cir2) `dot` (Circuit cir1) = Circuit $ \a ->
      let (cir1', b) = cir1 a
          (cir2', c) = cir2 b
      in (cir2' `dot` cir1', c)
```

The `Cat.id` function replaces itself with a copy of itself without maintaining any state. The purpose of the `(.)` function is to chain two arrows together from right to left. `(>>>)` and `(<<<)` are based on `(.)`. It needs to replace itself with the 'dot' of the two replacements returned by the execution of the argument `Circuits`.

```
instance Arrow Circuit where
  arr f = Circuit $ \a -> (arr f, f a)
  first (Circuit cir) = Circuit $ \ (b, d) ->
    let (cir', c) = cir b
    in (first cir', (c, d))
```

`arr` lifts a plain Haskell function as an arrow. Like with `id`, the replacement it gives is just itself, since a plain Haskell function can't maintain state.

Now we need a function to run a circuit:

```
runCircuit :: Circuit a b -> [a] -> [b]
runCircuit _ [] = []
runCircuit cir (x:xs) =
  let (cir',x') = unCircuit cir x
  in x' : runCircuit cir' xs
```

For `mapAccumL` fans like me, this can alternatively be written as

```
runCircuit :: Circuit a b -> [a] -> [b]
runCircuit cir inputs =
  snd $ mapAccumL (\cir x -> unCircuit cir x) cir inputs
```

or, after eta-reduction, simply as:

```
runCircuit :: Circuit a b -> [a] -> [b]
runCircuit cir = snd . mapAccumL unCircuit cir
```

43.3 Circuit primitives

Let's define a generalized accumulator to be the basis for our later work. `accum'` is a less general version of `accum`.

```
-- | Accumulator that outputs a value determined by the supplied function.
accum :: acc -> (a -> acc -> (b, acc)) -> Circuit a b
accum acc f = Circuit $ \input ->
  let (output, acc') = input `f` acc
  in (accum acc' f, output)

-- | Accumulator that outputs the accumulator value.
accum' :: b -> (a -> b -> b) -> Circuit a b
accum' acc f = accum acc (\a b -> let b' = a `f` b in (b', b'))
```

Here is a useful concrete accumulator which keeps a running total of all the numbers passed to it as inputs.

```
total :: Num a => Circuit a a
total = accum' 0 (+)
```

We can run this circuit, like this:

```
*Main> runCircuit total [1,0,1,0,0,2]
[1,1,2,2,2,4]
*Main>
```

43.4 Arrow proc notation

Here is a statistical mean function:

```
mean1 :: Fractional a => Circuit a a
mean1 = (total &&& (const 1 ^>> total)) >>> arr (uncurry (/))
```

It maintains two accumulator cells, one for the sum, and one for the number of elements. It splits the input using the "fanout" operator `&&&` and before the input of the second stream, it discards the input value and replaces it with 1.

`const 1 ^>> total` is shorthand for `arr (const 1) >>> total`. The first stream is the sum of the inputs. The second stream is the sum of 1 for each input (i.e. a count of the number of inputs). Then, it merges the two streams with the `(/)` operator.

Here is the same function, but written using arrow `proc` notation:

```
mean2 :: Fractional a => Circuit a a
mean2 = proc value -> do
  t <- total -< value
  n <- total -< 1
  returnA -< t / n
```

The `proc` notation describes the same relationship between the arrows, but in a totally different way. Instead of explicitly describing the wiring, you glue the arrows together using variable bindings and pure Haskell expressions, and the compiler works out all the `arr`, `(>>>)`, `(&&&)` stuff for you. Arrow `proc` notation also contains a pure 'let' statement exactly like the monadic `do` one.

`proc` is the keyword that introduces arrow notation, and it binds the arrow input to a pattern (value in this example). Arrow statements in a `do` block take one of these forms:

- *variable binding pattern* `<- arrow` `<- pure expression giving arrow input`
- *arrow* `<- pure expression giving arrow input`

Like with monads, the `do` keyword is needed only to combine multiple lines using the variable binding patterns with `<-`. As with monads, the last line isn't allowed to have a variable binding pattern, and the output value of the last line is the output value of the arrow. `returnA` is an arrow just like 'total' is (in fact, `returnA` is just the identity arrow, defined as `arr id`).

Also like with monads, lines other than the last line may have no variable binding, and you get the effect only, discarding the return value. In `Circuit`, there would never be a point in doing this (since no state can escape except through the return value), but in many arrows there would be.

As you can see, for this example the `proc` notation makes the code much more readable. Let's try them:

```
*Main> runCircuit mean1 [0,10,7,8]
[0.0,5.0,5.666666666666667,6.25]
*Main> runCircuit mean2 [0,10,7,8]
[0.0,5.0,5.666666666666667,6.25]
*Main>
```

43.5 Hangman: Pick a word

Now for our Hangman game. Let's pick a word from a dictionary:

```
generator :: Random a => (a, a) -> StdGen -> Circuit () a
generator range rng = accum rng $ \() rng -> randomR range rng

dictionary = ["dog", "cat", "bird"]

pickWord :: StdGen -> Circuit () String
pickWord rng = proc () -> do
  idx <- generator (0, length dictionary-1) rng -< ()
  returnA -< dictionary !! idx
```

With `generator`, we're using the accumulator functionality to hold our random number generator. `pickWord` doesn't introduce anything new, except that the generator arrow is constructed by a Haskell function that takes arguments. Here is the output:

```
*Main> rng <- getStdGen
*Main> runCircuit (pickWord rng) [(), (), ()]
["dog", "bird", "dog"]
*Main>
```

We will use these little arrows in a minute. The first returns `True` the first time, then `False` afterwards:

```
oneShot :: Circuit () Bool
oneShot = accum True $ \_ acc -> (acc, False)
```

```
*Main> runCircuit oneShot [( ), ( ), ( ), ( ), ( )]
[True, False, False, False, False]
```

The second stores a value and returns it, when it gets a new one:

```
delayedEcho :: a -> Circuit a a
delayedEcho acc = accum acc (\a b -> (b,a))
```

which can be shortened to:

```
delayedEcho :: a -> Circuit a a
delayedEcho acc = accum acc (flip (,))
```

```
*Main> runCircuit (delayedEcho False) [True, False, False, False, True]
[False, True, False, False, False]
```

The game's main arrow will be executed repeatedly, and we would like to pick the word only once on the first iteration, and have it remember it for the rest of the game. Rather than just mask its output on subsequent loops, we'd prefer to actually run `pickWord` only once (since in a real implementation it could be very slow). However, as it stands, the data flow in a `Circuit` **must** go down **all** the paths of component arrows. In order to allow the data flow to go down one path and not another, we need to make our arrow an instance of `ArrowChoice`. Here's the minimal definition:

```
instance ArrowChoice Circuit where
  left orig@(Circuit cir) = Circuit $ \ebd -> case ebd of
    Left b -> let (cir', c) = cir b
                in (left cir', Left c)
    Right d -> (left orig, Right d)

getWord :: StdGen -> Circuit () String
getWord rng = proc () -> do
  -- If this is the first game loop, run pickWord. mPicked becomes Just
  <word>.
  -- On subsequent loops, mPicked is Nothing.
  firstTime <- oneShot <- ( )
  mPicked <- if firstTime
    then do
      picked <- pickWord rng <- ( )
      returnA <- Just picked
    else returnA <- Nothing
  -- An accumulator that retains the last 'Just' value.
  mWord <- accum' Nothing mplus <- mPicked
  returnA <- fromJust mWord
```

Because `ArrowChoice` is defined, the compiler now allows us to put an `if` after `<-`, and thus choose which arrow to execute (either run `pickWord`, or skip it). Note that this is not a normal Haskell `if`: The compiler implements this using `ArrowChoice`. The compiler also implements `case` here in the same way.

It is important to understand that none of the local name bindings, including the `proc` argument, is in scope between `<-` and `<->` except in the condition of an `if` or `case`. For example, this is illegal:

```
{-
proc rng -> do
  idx <- generator (0, length dictionary-1) rng <- ( ) -- ILLEGAL
  returnA <- dictionary !! idx
```

```
-}
```

The arrow to execute, here `generator (0, length dictionary -1) rng`, is evaluated in the scope that exists outside the 'proc' statement. `rng` does not exist in this scope. If you think about it, this makes sense, because the arrow is constructed at the beginning only (outside proc). If it were constructed for each execution of the arrow, how would it keep its state?

Let's try `getWord`:

```
*Main> rng <- getStdGen
*Main> runCircuit (getWord rng) [(0, ()), (0, ()), (0, ()), (0, ())]
["dog", "dog", "dog", "dog", "dog", "dog"]
*Main>
```

43.6 Hangman: Main program

Now here is the game:

```
attempts :: Int
attempts = 5

livesLeft :: Int -> String
livesLeft hung = "Lives: ["
  ++ replicate (attempts - hung) '#'
  ++ replicate hung ' '
  ++ "]"

hangman :: StdGen -> Circuit String (Bool, [String])
hangman rng = proc userInput -> do
  word <- getWord rng -< ()
  let letter = listToMaybe userInput
      guessed <- updateGuess -< (word, letter)
      hung <- updateHung -< (word, letter)
  end <- delayedEcho True -< not (word == guessed || hung >= attempts)
  let result = if word == guessed
      then [guessed, "You won!"]
      else if hung >= attempts
      then [guessed, livesLeft hung, "You died!"]
      else [guessed, livesLeft hung]
  returnA -< (end, result)
where
  updateGuess :: Circuit (String, Maybe Char) String
  updateGuess = accum' (repeat ' _') $ \ (word, letter) guess ->
    case letter of
      Just l -> map (\(w, g) -> if w == l then w else g) (zip word guess)
      Nothing -> take (length word) guess

  updateHung :: Circuit (String, Maybe Char) Int
  updateHung = proc (word, letter) -> do
    total -< case letter of
      Just l -> if l `elem` word then 0 else 1
      Nothing -> 0

main :: IO ()
main = do
  rng <- getStdGen
  interact $ unlines
    . ("Welcome to Arrow Hangman:")
    -- Concatenate lines out output
    -- Prepend a greeting to the output
```

```

    . concat . map snd . takeWhile fst -- Take the [String]s as long as the
first element of the tuples is True
    . runCircuit (hangman rng)         -- Process the input lazily
    . (""):                             -- Act as if the user pressed ENTER
once at the start
    . lines                               -- Split input into lines

```

And here's an example session. For best results, compile the game and run it from a terminal rather than from GHCi:

```

Welcome to Arrow Hangman
---
Lives: [#####]
a
---
Lives: [#### ]
g
--g
Lives: [#### ]
d
d_g
Lives: [#### ]
o
dog
You won!

```

43.7 Advanced stuff

In this section I will complete the coverage of arrow notation.

43.7.1 Combining arrow commands with a function

We implemented `mean2` like this:

```

mean2 :: Fractional a => Circuit a a
mean2 = proc value -> do
    t <- total -< value
    n <- total -< 1
    returnA -< t / n

```

GHC defines a banana bracket syntax for combining arrow statements with a function that operates on arrows. (In Ross Paterson's paper ³ a `form` keyword is used, but GHC adopted the banana bracket instead.) Although there's no real reason to, we can write `mean` like this:

```

mean3 :: Fractional a => Circuit a a
mean3 = proc value -> do
    (t, n) <- (| (&&&) (total -< value) (total -< 1) |)
    returnA -< t / n

```

The first item inside the `(| ... |)` is a function that takes any number of arrows as input and returns an arrow. Infix notation cannot be used here. It is followed by the arguments, which are in the form of proc statements. These statements may contain `do` and bindings

³ Ross Paterson's Paper specifying arrow proc notation [^{\http://www.soi.city.ac.uk/~ross/papers/notation.html}](http://www.soi.city.ac.uk/~ross/papers/notation.html)

with `<-` if you like. Each argument is translated into an arrow and given as an argument to the function (`&&&`).

You may ask, what is the point of this? We can combine arrows quite happily without the `proc` notation. Well, the point is that you get the convenience of using local variable bindings in the statements.

The banana brackets are in fact not required. The compiler is intelligent enough to assume that this is what you mean when you write it like this (note that infix notation *is* allowed here):

```
mean4 :: Fractional a => Circuit a a
mean4 = proc value -> do
  (t, n) <- (total -< value) &&& (total -< 1)
  returnA -< t / n
```

So why do we need the banana brackets? For situations where this plainer syntax is ambiguous. The reason is that the arrow part of a `proc` command is *not an ordinary Haskell expression*. Recall that for arrows specified in `proc` statements, the following things hold true:

- Local variable bindings are only allowed in the input expression after `-<`, and for the `if` and `case` condition. The arrow itself is interpreted in the scope that exists outside `proc`.
- `if` and `case` statements are not plain Haskell. They are implemented using `ArrowChoice`.
- Functions used to combine arrows are not normal Haskell either. They are shorthand for banana bracket notation.

43.7.2 Recursive bindings

At the risk of wearing out the `mean` example, here is yet another way to implement it using recursive bindings. In order for this to work, we'll need an arrow that delays its input by one step:

```
delay :: a -> Circuit a a
delay last = Circuit $ \this -> (delay this, last)
```

Here is what `delay` does:

```
*Main> runCircuit (delay 0) [5,6,7]
[0,5,6]
*Main>
```

Here is our recursive version of `mean`:

```
mean5 :: Fractional a => Circuit a a
mean5 = proc value -> do
  rec
    (lastTot, lastN) <- delay (0,0) -< (tot, n)
    let (tot, n) = (lastTot + value, lastN + 1)
        let mean = tot / n
    returnA -< mean
```

The `rec` block resembles a `do`' block, except that

- The last line can be, and usually is, a variable binding. It doesn't matter whether it's a `let` or a `do`-block binding with `<-`.
- The `rec` block doesn't have a return value. `var <- rec ...` is illegal, and `rec` is not allowed to be the last element in a `do` block.
- The use of variables is expected to form a cycle (otherwise there is no point in `rec`).

The machinery of `rec` is handled by the `loop` function of the `ArrowLoop` class, which we define for `Circuit` like this:

```
instance ArrowLoop Circuit where
  loop (Circuit cir) = Circuit $ \b ->
    let (cir', (c,d)) = cir (b,d)
    in (loop cir', c)
```

Behind the scenes, the way it works is this:

- Any variables defined in `rec` that are forward referenced in `rec` are looped around by passing them through the second tuple element of `loop`. Effectively the variable bindings and references to them can be in any order (but the order of arrow statements is significant in terms of effects).
- Any variables defined in `rec` that are referenced from outside `rec` are returned in the first tuple element of `loop`.

It is important to understand that `loop` (and therefore `rec`) simply binds variables. It doesn't hold onto values and pass them back in the next invocation - `delay` does this part. The cycle formed by the variable references must be broken by some sort of delay arrow or lazy evaluation, otherwise the code would die in an infinite loop as if you had written `let a = a+1` in plain Haskell.

43.7.3 ArrowApply

As mentioned before, the arrow part of an arrow statement (before `<-`) can't contain any variables bound inside `'proc'`. There is an alternative operator, `-<<` which removes this restriction. It requires the arrow to implement the `ArrowApply` typeclass.

44 Understanding arrows

i Information

We have permission to import material from the Haskell arrows page¹. See the talk page for details.

Arrows, like monads, express computations that happen within a context. However, they are a more general abstraction than monads, and thus allow for contexts beyond what the `Monad` class makes possible. The essential difference between the abstractions can be summed up thus:

Just as we think of a monadic type `m a` as representing a 'computation delivering an `a`'; so we think of an arrow type `a b c`, (that is, the application of the parameterised type `a` to the two parameters `b` and `c`) as representing 'a computation with input of type `b` delivering a `c`'; arrows make the dependence on input explicit.

This chapter has two main parts. Firstly, we will consider the main ways in which arrow computations differ from those expressed by the functor classes we are used to, and also briefly present some of the core arrow-related type classes. Secondly, we will study the parser example used by John Hughes in the original presentation of arrows.

44.1 Pocket guide to Arrow

44.1.1 Arrows look a lot like functions

The first step towards understanding arrows is realising how similar they are to functions. Like `(->)`, the type constructor of an `Arrow` instance has kind `* -> * -> *`, that is, it takes two type arguments — unlike, say, a `Monad`, which takes only one. Crucially, `Arrow` has `Category` as a superclass. `Category` is, to put it very roughly, the class for things that can be composed like functions:

```
class Category y where
  id  :: y a a          -- identity for composition.
  (.) :: y b c -> y a b -> y a c -- associative composition.
```

(It goes without saying that functions have an instance of `Category` — in fact, they are `Arrows` as well.)

A practical consequence of this similarity is that you have to think in point-free terms when looking at expressions full of `Arrow` operators, such as this example from the tutorial²:

```
(total &&& (const 1 ^>> total)) >>> arr (uncurry (/))
```

Otherwise you will quickly get lost looking for the values to apply things on. In any case, it is easy to get lost even if you look at such expressions in the right way. That's what `proc` notation is all about: adding extra variable names and whitespace while making some operators implicit, so that `Arrow` code gets easier to follow.

Before continuing, we should mention that `Control.Category`³ also defines `(<<<)` = `(.)` and `(>>>)` = `flip (.)`, which is very commonly used to compose arrows from left to right.

44.1.2 Arrow glides between `Applicative` and `Monad`

In spite of the warning we gave just above, arrows can be compared to applicative functors and monads. The trick is making the functors look more like arrows, and not the opposite. That is, you should not compare `Arrow y => y a b` with `Applicative f => f a` or `Monad m => m a`, but rather with:

- `Applicative f => f (a -> b)`, the type of *static morphisms* i.e. the values to the left of `(<*>)`; and
- `Monad m => a -> m b`, the type of *Kleisli morphisms* i.e. the functions to the right of `(>=)`⁴.

Morphisms are the sort of things that can have `Category` instances, and indeed we could write instances of `Category` for both static and Kleisli morphisms. This modest twisting is enough for a sensible comparison.

If this argument reminds you of the sliding scale of power⁵ discussion, in which we compared `Functor`, `Applicative` and `Monad`, that is a sign you are paying attention, as we are following exactly the same route. Back then, we remarked how the types of the morphisms limit how they can, or cannot, create effects. Monadic binds can induce near-arbitrary changes to the effects of a computation depending on the `a` values given to the Kleisli morphism, while the isolation between the functorial wrapper and the function arrow in static morphisms mean the effects in an applicative computation do not depend at all on the values within the functor⁶.

What sets arrows apart from this point of view is that in `Arrow y => y a b` there is no such connection between the context `y` and a function arrow to determine so rigidly the range of possibilities. Both static and Kleisli morphisms can be made into `Arrows`, and conversely an instance of `Arrow` can be made as limited as an `Applicative` one or as powerful as a

² Chapter 43 on page 291

³ <http://hackage.haskell.org/packages/archive/base/latest/doc/html/Control-Category.html>

⁴ Those two concepts are usually known as *static arrows* and *Kleisli arrows* respectively. Since using the word "arrow" with two subtly different meanings would make this text horribly confusing, we opted for "morphism", which is a synonym for this alternative meaning.

⁵ <https://en.wikibooks.org/wiki/Haskell%2FApplicative%20functors%20II%23A%20sliding%20scale%20of%20power>

⁶ Incidentally, that is why they are called *static*: the effects are set in stone by the sequencing of computations; the generated values cannot affect them.

Monad one ⁷. More interestingly, we can use `Arrow` to take a third option and have both applicative-like static effects and monad-like dynamic effects in a single context, but kept separate from each other. Arrows make it possible to fine tune how effects are to be combined. That is the main thrust of the classic example of the arrow-based parser, which we will have a look at near the end of this chapter.

44.1.3 An Arrow can multitask

These are the `Arrow` methods:

```
class Category y => Arrow y where
  -- Minimal implementation: arr and first
  arr    :: (a -> b) -> y a b          -- converts function to arrow
  first  :: y a b -> y (a, c) (b, c)  -- maps over first component

  second :: y a b -> y (c, a) (c, b)  -- maps over second component
  (***)  :: y a c -> y b d -> y (a, b) (c, d) -- first and second combined
  (&&&)   :: y a b -> y a c -> y a (b, c) -- (***) on a duplicated value
```

With these methods, we can carry out multiple computations at each step of what seems to be a linear chain of composed arrows. That is done by keeping values used in separate computations as elements of pairs in a (possibly nested) pair, and then using the using pair-handling functions to reach each value when desired. That allows, for instance, saving intermediate values for later or using functions with multiple arguments conveniently ⁸.

Visualising may help understanding the data flow in an arrow computation. Here are illustrations of (`>>>`) and the five `Arrow` methods:

⁷ For details, see *Idioms are oblivious, arrows are meticulous, monads are promiscuous* ^{<http://homepages.inf.ed.ac.uk/wadler/topics/monads.html>}, by Sam Lindley, Philip Wadler and Jeremy Yallop.

⁸ "Conveniently" is arguably too strong a word, though, given how confusing handling nested tuples can get. *Ergo*, proc notation.

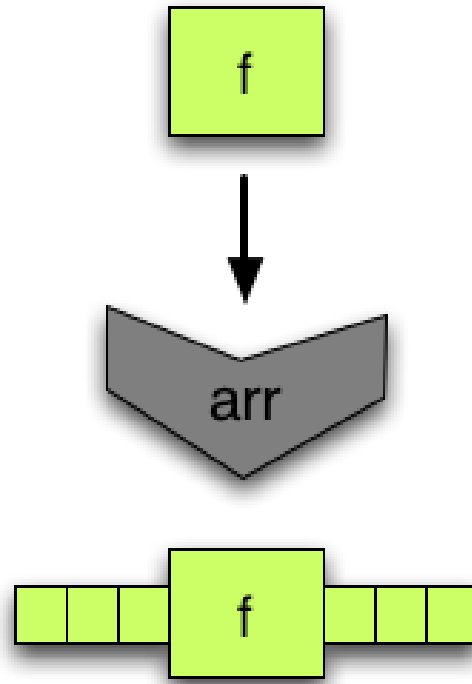

Figure 6 `arr` turns a function into an arrow, composable with other arrows. Naturally, not all arrows are created in this way.

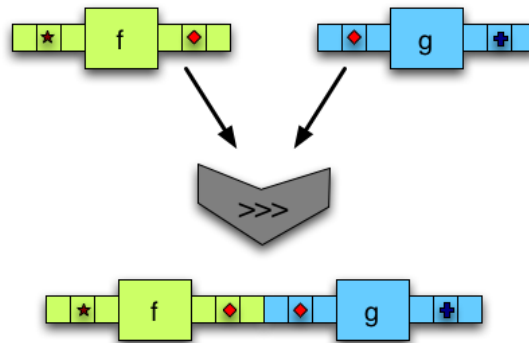

Figure 7 `(>>>)` composes two arrows. The output of the first one is fed to the second.

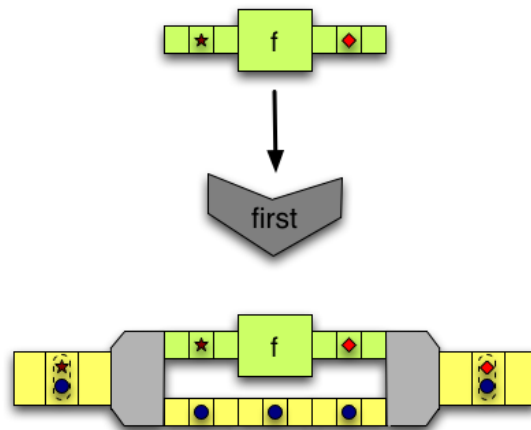

Figure 8 `first` takes two inputs side by side. The first one is modified using an arrow, while the second is left unchanged.

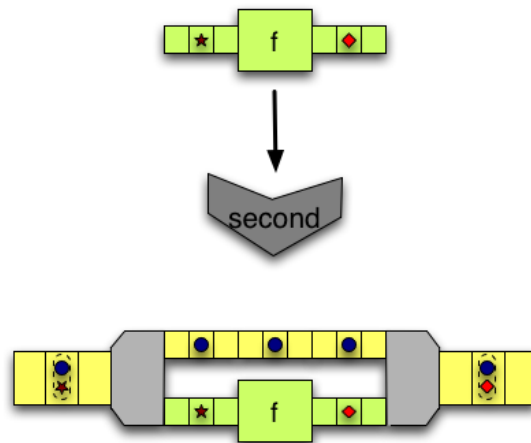

Figure 9 `second`, conversely, takes two inputs but only modifies the second.

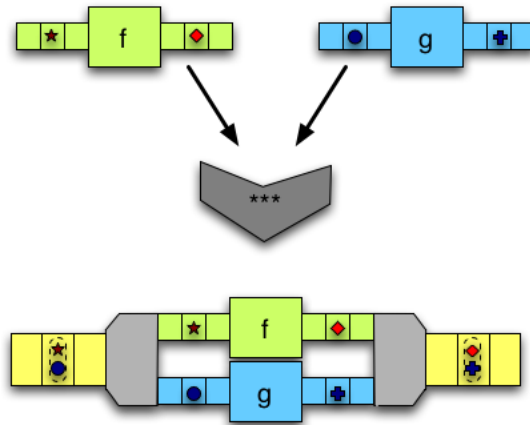

Figure 10 (***) takes two inputs and modifies them with two arrows, one for each input.

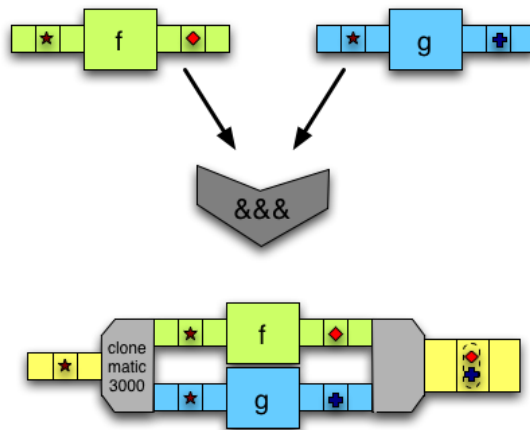

Figure 11 (&&&) takes one input, duplicates it and modifies each copy with a different arrow.

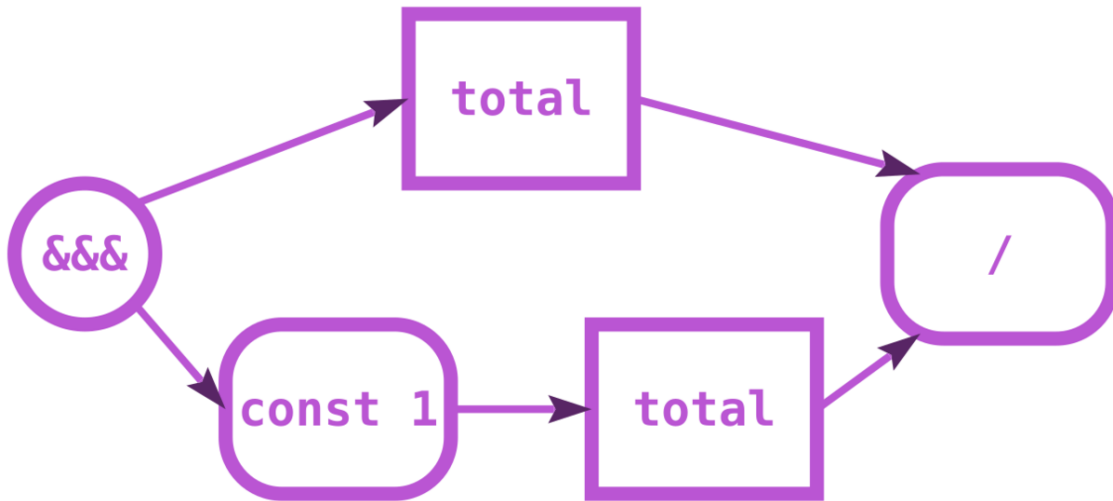

Figure 12 Data flow for the `mean1` arrow from the tutorial^a. Rectangles are arrows, rounded rectangles are arrows made with `arr`, circles are other data flow split/merge points. Other combinators are left implicit. Corresponding code:

```
(total &&& (const 1 ^>> total))
  >>> arr (uncurry (/))
```

^a Chapter 43.3 on page 293

It is worth mentioning that `Control.Arrow`⁹ defines `returnA = arr id` as a do-nothing arrow. One of the arrow laws says `returnA` must be equivalent to the `id` from the `Category` instance¹⁰.

44.1.4 An `ArrowChoice` can be resolute

If `Arrow` makes multitasking possible, `ArrowChoice` forces a decision on what task to do.

```
class Arrow y => ArrowChoice y where
  -- Minimal implementation: left
  left :: y a b -> y (Either a c) (Either b c)      -- maps over left
  choice

  right :: y a b -> y (Either c a) (Either c b)    -- maps over right
  choice
  (+++) :: y a c -> y b d -> y (Either a b) (Either c d) -- left and right
  combined
  (|||) :: y a c -> y b c -> y (Either a b) c      -- (+++), then merge
  results
```

`Either` provides a way to tag the values, so that different arrows can handle them depending on whether they are tagged with `Left` or `Right`. Note that these methods involving `Either` are entirely analogous to those involving pairs offered by `Arrow`.

⁹ <http://hackage.haskell.org/packages/archive/base/latest/doc/html/Control-Arrow.html>

¹⁰ `Arrow` has laws, and so do the other arrow classes we are discussing in these two chapters. We won't pause to pore over the laws here, but you can check them in the `Control.Arrow` ^{<http://hackage.haskell.org/packages/archive/base/latest/doc/html/Control-Arrow.html>} documentation.

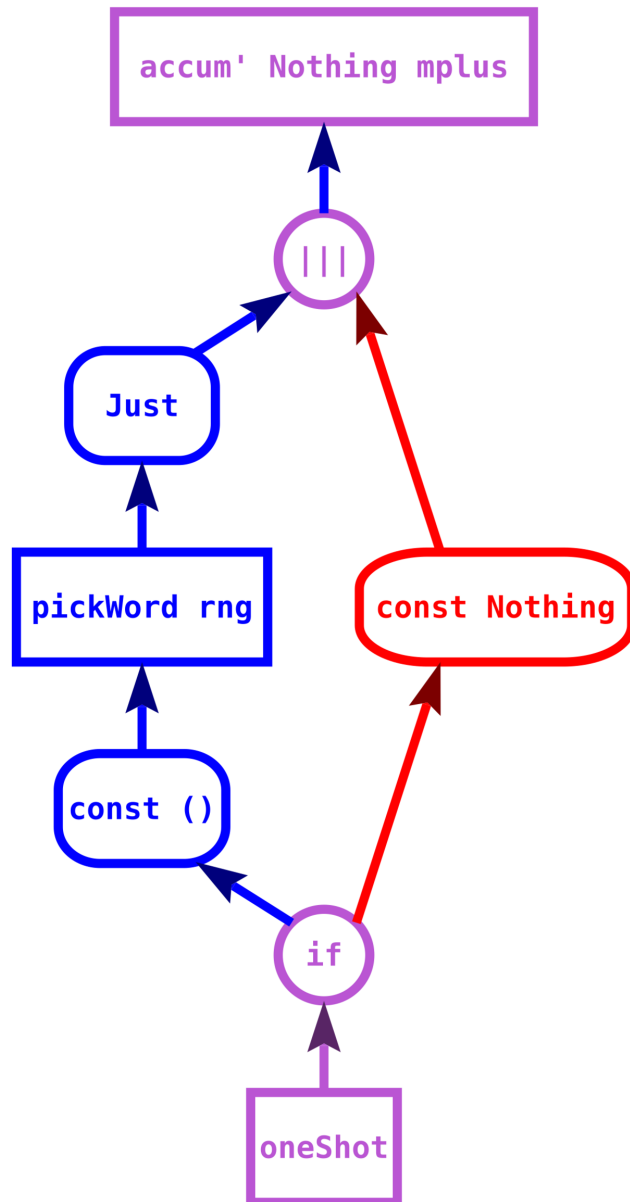

Figure 13 Data flow in a fragment of the `getWord` example of the tutorial^a. Blue indicates a `Left` tag and red indicates `Right`. Note that the `if` construct of `proc` notation sends `True` to `Left` and `False` to `Right`. Corresponding code:

```
proc () -> do
  firstTime <- oneShot -< ()
  mPicked <- if firstTime
    then do
      picked <- pickWord rng -< ()
      returnA -< Just picked
    else returnA -< Nothing
  accum' Nothing mplus -< mPicked
```

^a <https://en.wikibooks.org/wiki/Haskell%2FArrow%20tutorial%23Hangman%3A%20Pick%20a%20word>

44.1.5 An ArrowApply is just boring

As the name suggests, `ArrowApply` makes it possible to apply arrows to values directly midway through an arrow computation. Ordinary `Arrows` do not allow that — we can just compose them on and on and on. Application only happens right at the end, once a run-arrow function of some sort is used to get a plain function from the arrow.

```
class Arrow y => ArrowApply y where
  app :: y (y a b, a) b -- applies first component to second
```

(For instance, `app` for functions is `uncurry ($) = \ (f, x) -> f x .`)

`app`, however, comes at a steep price. Building an arrow as a value within an arrow computation and then eliminating it through application implies allowing the values within the computation to affect the context. That sounds a lot like what monadic binds do. It turns out that an `ArrowApply` is *exactly* equivalent to some `Monad` as long as the `ArrowApply` laws are followed. The ultimate consequence is that `ArrowApply` arrows cannot realise any of the interesting possibilities `Arrow` allows but `Monad` doesn't, such as having a partly static context.

The real flexibility with arrows comes with the ones that aren't monads, otherwise it's just a clunkier syntax.

44.1.6 Arrow combinators crop up in unexpected places

Functions are the trivial example of arrows, and so all of the `Control.Arrow` functions shown above can be used with them. For that reason, it is quite common to see arrow combinators being used in code that otherwise has nothing to do with arrows. Here is a summary of what they do with plain functions, alongside with combinators in other modules that can be used in the same way (in case you prefer the alternative names, or just prefer using simple modules for simple tasks).

Combinator	What it does (specialised to <code>(->)</code>)	Alternatives
<code>(>>>)</code>	<code>flip (.)</code>	
<code>first</code>	<code>\f (x, y) -> (f x, y)</code>	<code>first</code> (<code>Data.Bifunctor</code> ¹¹)
<code>second</code>	<code>\f (x, y) -> (x, f y)</code>	<code>fmap</code> ; <code>second</code> (<code>Data.Bifunctor</code> ¹²)
<code>(***)</code>	<code>\f g (x, y) -> (f x, g y)</code>	<code>bimap</code> (<code>Data.Bifunctor</code> ¹³)
<code>(&&&)</code>	<code>\f g x -> (f x, g x)</code>	<code>liftA2</code>
<code>left</code>	Maps over Left case.	<code>(,)</code> (<code>Control.Applicative</code> ¹⁴) <code>first</code> (<code>Data.Bifunctor</code> ¹⁵)
<code>right</code>	Maps over Right case.	<code>fmap</code> ; <code>second</code> (<code>Data.Bifunctor</code> ¹⁶)

11 <http://hackage.haskell.org/packages/archive/base/latest/doc/html/Data-Bifunctor.html>

12 <http://hackage.haskell.org/packages/archive/base/latest/doc/html/Data-Bifunctor.html>

13 <http://hackage.haskell.org/packages/archive/base/latest/doc/html/Data-Bifunctor.html>

14 <http://hackage.haskell.org/packages/archive/base/latest/doc/html/Control-Applicative.html>

15 <http://hackage.haskell.org/packages/archive/base/latest/doc/html/Data-Bifunctor.html>

16 <http://hackage.haskell.org/packages/archive/base/latest/doc/html/Data-Bifunctor.html>

Combinator	What it does	Alternatives
(+++)	(specialised to (->)) Maps over both cases.	bimap (Data.Bifunctor ¹⁷)
()	Eliminates Either.	either (Data.Either ¹⁸)
app	\(f, x) -> f x	uncurry (\$)

The `Data.Bifunctor` module provides the `Bifunctor` class, of which `pairs` and `Either` are instances. A `Bifunctor` is very much like a `Functor`, except that there are two independent ways of mapping functions over it, corresponding to the `first` and `second` methods¹⁹.

Exercises:

1. Write implementations for `second`, `(***)` and `(&&&)`. Use just `(>>>)`, `arr`, and `first` (plus any plain functions) to implement `second`; after that, you can use the other combinators once you have implemented them.
2. Write an implementation for `right` in terms of `left`.
3. Implement `liftY2 :: Arrow y =>`

$$(a \rightarrow b \rightarrow c) \rightarrow y \ r \ a \rightarrow y \ r \ b \rightarrow y \ r \ c$$

44.2 Using arrows

44.2.1 Avoiding leaks

Arrows were originally motivated by an efficient parser design found by Swierstra & Duponcheel²⁰.

To describe the benefits of their design, let's examine exactly how monadic parsers work.

If you want to parse a single word, you end up with several monadic parsers stacked end to end. Taking `Parsec` as an example²¹, a parser for the string "word" can be thought of as²²:

```
word = do char 'w' >> char 'o' >> char 'r' >> char 'd'
      return "word"
```

Each character is tried in order, if "word" is the input, then the first three parsers will succeed, and the last one will fail, making the entire string "word" parser fail.

17 <http://hackage.haskell.org/packages/archive/base/latest/doc/html/Data-Bifunctor.html>

18 <http://hackage.haskell.org/packages/archive/base/latest/doc/html/Data-Either.html>

19 `Data.Bifunctor` was only added to the core GHC libraries in version 7.10, so it might not be installed if you are using an older version. In that case, you can install the `bifunctors` package, which also includes several other bifunctor-related modules

20 Swierstra, Duponcheel. *Deterministic, error correcting parser combinators*. <http://citeseerx.ist.psu.edu/viewdoc/summary?doi=10.1.1.29.2760>

21 `Parsec` is a popular and powerful parsing library. See the `parsec` documentation on Hackage ^{<https://hackage.haskell.org/package/parsec>} for more information.

22 "Thought of as" because in actual code we evidently wouldn't return the string explicitly in such a crude way. `Parsec` offers a combinator `string` which would allow writing `word = string "word"`. In any case, right now we are only concerned with how characters are tested, and so the crude parser is good enough for a mental model.

If you want to parse one of two options, you create a new parser for each and they are tried in order. The first one must fail in order for the next to be tried with the same input.

```
ab = char 'a' <|> char 'b' <|> char 'c' -- (<|>) is a combinator for
alternatives.
```

To parse "c" successfully, both 'a' and 'b' must have been tried.

```
one = do char 'o' >> char 'n' >> char 'e'
      return "one"

two = do char 't' >> char 'w' >> char 'o'
      return "two"

three = do char 't' >> char 'h' >> char 'r' >> char 'e' >> char 'e'
        return "three"

nums = one <|> two <|> three
```

With these three parsers, you can't detect that the string "four" will fail the parser `nums` until the last parser has failed.

If one of the options can consume much of the input but will fail, you still must descend down the chain of parsers until the final parser fails. All of the input that can possibly be consumed by later parsers must be retained in memory in case one of them does consume it. That can lead to much more space usage than you would naively expect — a situation often called a *space leak*.

The general pattern with monadic parsers, then, is that each option must fail or one option must succeed.

Can it be done better?

Swierstra & Duponcheel (1996) noticed that a smarter parser could immediately fail upon seeing the very first character. For example, in the `nums` parser above, the choice of first letter parsers was limited to either the letter 'o' for "one" or the letter 't' for both "two" and "three". This smarter parser would also be able to garbage collect input sooner because it could look ahead to see if any other parsers might be able to consume the input, and drop input that could not be consumed. This new parser is a lot like the monadic parsers with the major difference that it exports *static* information. It's like a monad, but it also tells you what it can parse.

There's one major problem. This doesn't fit into the `Monad` interface. Monadic composition works with $(a \rightarrow m\ b)$ functions, and functions alone. There's no way to attach static information. You have only one choice, throw in some input, and see if it passes or fails.

Back when this issue first arose, the monadic interface was being touted as a completely general purpose tool in the functional programming community, so finding that there was some particularly useful code that just couldn't fit into that interface was something of a setback. This is where arrows come in. John Hughes's *Generalising monads to arrows* proposed the arrows abstraction as new, more flexible tool.

Static and dynamic parsers

Let us examine Swierstra and Duponcheel's parser in greater detail, from the perspective of arrows as presented by Hughes. The parser has two components: a fast, static parser which tells us if the input is worth trying to parse; and a slow, dynamic parser which does the actual parsing work.

```
import Control.Arrow
import qualified Control.Category as Cat
import Data.List (union)

data Parser s a b = P (StaticParser s) (DynamicParser s a b)
data StaticParser s = SP Bool [s]
newtype DynamicParser s a b = DP ((a, [s]) -> (b, [s]))
```

The static parser consists of a flag, which tells us if the parser can accept the empty input, and a list of possible **starting characters**. For example, the static parser for a single character would be as follows:

```
spCharA :: Char -> StaticParser Char
spCharA c = SP False [c]
```

It does not accept the empty string (`False`) and the list of possible starting characters consists only of `c`.

The dynamic parser needs a little more dissecting. What we see is a function that goes from $(a, [s])$ to $(b, [s])$. It is useful to think in terms of sequencing two parsers: each parser consumes the result of the previous parser (`a`), along with the remaining bits of input stream (`[s]`), it does something with `a` to produce its own result `b`, consumes a bit of string and returns *that*. So, as an example of this in action, consider a dynamic parser $(Int, String) \rightarrow (Int, String)$, where the `Int` represents a count of the characters parsed so far. The table below shows what would happen if we sequence a few of them together and set them loose on the string "cake" :

	result	remaining
before	0	cake
after first parser	1	ake
after second parser	2	ke
after third parser	3	e

So the point here is that a dynamic parser has two jobs : it does something to the output of the previous parser (informally, $a \rightarrow b$), and it consumes a bit of the input string, (informally, $[s] \rightarrow [s]$), hence the type $DP ((a, [s]) \rightarrow (b, [s]))$. Now, in the case of a dynamic parser for a single character (type $(Char, String) \rightarrow (Char, String)$), the first job is trivial. We ignore the output of the previous parser, return the character we have parsed and consume one character off the stream:

```
dpCharA :: Char -> DynamicParser Char Char Char
dpCharA c = DP (\(_,x:xs) -> (x,xs))
```

This might lead you to ask a few questions. For instance, what's the point of accepting the output of the previous parser if we're just going to ignore it? And shouldn't the dynamic parser be making sure that the current character off the stream matches the character to

be parsed by testing `x == c`? The answer to the second question is no – and in fact, this is part of the point: the work is not necessary because the check would already have been performed by the static parser. Naturally, things are only so simple because we are testing just one character. If we were writing a parser for several characters in sequence we would need dynamic parsers that actually tested the second and further characters; and if we wanted to build an output string by chaining several parsers of characters then we would need the output of previous parsers.

Time to put both parsers together. Here is our S+D style parser for a single character:

```
charA :: Char -> Parser Char Char Char
charA c = P (SP False [c]) (DP (\(_,x:xs) -> (x,xs)))
```

Bringing the arrow combinators in

With the preliminary bit of exposition done, we are now going to implement the Arrow class for `Parser s`, and by doing so, give you a glimpse of what makes arrows useful. So let's get started:

```
-- We explain the Eq s constraint below.
instance Eq s => Arrow (Parser s) where
```

`arr` should convert an arbitrary function into a parsing arrow. In this case, we have to use "parse" in a very loose sense: the resulting arrow accepts the empty string, and *only the empty string* (its set of first characters is `[]`). Its sole job is to take the output of the previous parsing arrow and do something with it. That being so, it does not consume any input.

```
arr f = P (SP True []) (DP (\(b,s) -> (f b,s)))
```

Likewise, the `first` combinator is relatively straightforward. Given a parser, we want to produce a new parser that accepts a pair of inputs `(b,d)`. The first component of the input `b`, is what we actually want to parse. The second part passes through untouched:

```
first (P sp (DP p)) = P sp (DP (\((b,d),s) ->
  let (c, s') = p (b,s)
  in ((c,d),s')))
```

We also have to supply the `Category` instance. `id` is entirely obvious, as `id = arr id` must hold:

```
instance Eq s => Cat.Category (Parser s) where
  id = P (SP True []) (DP (\(b,s) -> (b,s)))
  -- Or simply: id = P (SP True []) (DP id)
```

On the other hand, the implementation of `(.)` requires a little more thought. We want to take two parsers, and return a combined parser incorporating the static and dynamic parsers of both arguments:

```
-- The Eq s constraint is needed for using union here.
(P (SP empty1 start1) (DP p2)) .
(P (SP empty2 start2) (DP p1)) =
  P (SP (empty1 && empty2)
```

```
(if not empty1 then start1 else start1 `union` start2))
(DP (p2.p1))
```

Combining the dynamic parsers is easy enough; we just do function composition. Putting the static parsers together requires a little bit of thought. First of all, the combined parser can only accept the empty string if *both* parsers do. Fair enough, now how about the starting symbols? Well, the parsers are supposed to be in a sequence, so the starting symbols of the second parser shouldn't really matter. If life were simple, the starting symbols of the combined parser would only be `start1`. Alas, life is not simple, because parsers could very well accept the empty input. If the first parser accepts the empty input, then we have to account for this possibility by accepting the starting symbols from both the first and the second parsers²³.

So what do arrows buy us?

If you look back at our `Parser` type and blank out the static parser section, you might notice that this looks a lot like the arrow instances for functions.

```
arr f = \ (b, s) -> (f b, s)
first p = \ (b, d), s ->
    let (c, s') = p (b, s)
    in ((c, d), s')
```

```
id = id
p2 . p1 = p2 . p1
```

There's the odd `s` variable out for the ride, which makes the definitions look a little strange, but the outline of e.g. the simple `first` functions²⁴ is there. Actually, what you see here is roughly the arrow instance for the `State` monad/Kleisli morphism (`let f :: b -> c, p :: b -> State s c` and `(.)` actually be `(<=<) = flip (>=>)`).

That's fine, but we could have easily done that with `bind` in classic monadic style, with `first` becoming just an odd helper function that could be easily written with a bit of pattern matching. But remember, our `Parser` type is not just the dynamic parser — it also contains the static parser.

```
arr f = SP True []
first sp = sp
(SP empty1 start1) >>> (SP empty2 start2) = (SP (empty1 && empty2)
    (if not empty1 then start1 else start1 `union` start2))
```

This is not at all a function, it's just pushing around some data types, and it cannot be expressed in a monadic way. But the `Arrow` interface can deal with just as well. And when we combine the two types, we get a two-for-one deal: the static parser data structure goes along for the ride along with the dynamic parser. The `Arrow` interface lets us transparently compose and manipulate the two parsers, static and dynamic, as a unit, which we can then run as a traditional, unified function.

²³ A reasonable question at this point would be "Okay, we can compose the static parsers by uniting their lists, but when we are actually gone to test things with them?". The answer is that the static tests would be performed by the alternatives combinator, which unites two parsers to produce a parser that accepts input from either.

²⁴ Chapter 44.1.6 on page 309

44.3 Arrows in practice

Some examples of libraries using arrows:

- The Haskell XML Toolbox (project page²⁵ and library documentation²⁶) uses arrows for processing XML. There is a Wiki page in the Haskell Wiki with a somewhat Gentle Introduction to HXT²⁷.
- Netwire (page library documentation²⁸) is a library for *functional reactive programming* (FRP). FRP is a functional paradigm for handling events and time-varying values, with use cases including user interfaces, simulations and games. Netwire has an arrow interface as well as an applicative one.
- Yampa (Haskell Wiki page²⁹ library documentation³⁰) is another arrow-based FRP library, and a predecessor to Netwire.
- Hughes' arrow-style parsers were first described in his 2000 paper, but a usable implementation wasn't available until May 2005, when Einar Karttunen released PArrows³¹.

44.4 See also

- Bibliography on arrows (haskell.org)³²

44.5 Acknowledgements

This module uses text from *An Introduction to Arrows* by Shae Erisson, originally written for The Monad.Reader 4

25 <http://www.fh-wedel.de/~si/HXmlToolbox/index.html>

26 <https://hackage.haskell.org/package/hxt>

27 <http://www.haskell.org/haskellwiki/HXT>

28 <http://hackage.haskell.org/package/netwire>

29 <https://wiki.haskell.org/Yampa>

30 <https://hackage.haskell.org/package/Yampa>

31 <https://hackage.haskell.org/package/PArrows>

32 <http://www.haskell.org/arrows/biblio.html>

45 Continuation passing style (CPS)

Continuation Passing Style (CPS for short) is a style of programming in which functions do not return values; rather, they pass control onto a *continuation*, which specifies what happens next. In this chapter, we are going to consider how that plays out in Haskell and, in particular, how CPS can be expressed with a monad.

45.1 What are continuations?

To dispel puzzlement, we will have a second look at an example from way back in the book, when we introduced the (\$) operator¹:

```
> map ($) 2 [(2*), (4*), (8*)]
[4,8,16]
```

There is nothing out of ordinary about the expression above, except that it is a little quaint to write that instead of `map (*2) [2, 4, 8]`. The (\$) section makes the code appear backwards, as if we are applying a value to the functions rather than the other way around. And now, the catch: such an innocent-looking reversal is at heart of continuation passing style!

From a CPS perspective, `($ 2)` is a *suspended computation*: a function with general type `(a -> r) -> r` which, given another function as argument, produces a final result. The `a -> r` argument is the *continuation*; it specifies how the computation will be brought to a conclusion. In the example, the functions in the list are supplied as continuations via `map`, producing three distinct results. Note that suspended computations are largely interchangeable with plain values: `flip ($) 2` converts any value into a suspended computation, and passing `id` as its continuation gives back the original value.

45.1.1 What are they good for?

There is more to continuations than just a parlour trick to impress Haskell newbies. They make it possible to explicitly manipulate, and dramatically alter, the control flow of a program. For instance, returning early from a procedure can be implemented with continuations. Exceptions and failure can also be handled with continuations - pass in a continuation for success, another continuation for fail, and invoke the appropriate continuation. Other possibilities include "suspending" a computation and returning to it at another time, and implementing simple forms of concurrency (notably, one Haskell implementation, Hugs, uses continuations to implement cooperative concurrency).

¹ Chapter 19.4 on page 131

² That is, `\x -> ($) x`, fully spelled out as `\x -> \k -> k x`

In Haskell, continuations can be used in a similar fashion, for implementing interesting control flow in monads. Note that there usually are alternative techniques for such use cases, especially in tandem with laziness. In some circumstances, CPS can be used to improve performance by eliminating certain construction-pattern matching sequences (i.e. a function returns a complex structure which the caller will at some point deconstruct), though a sufficiently smart compiler *should* be able to do the elimination³.

45.2 Passing continuations

An elementary way to take advantage of continuations is to modify our functions so that they return suspended computations rather than ordinary values. We will illustrate how that is done with two simple examples.

45.2.1 pythagoras

Example: A simple module, no continuations

```
-- We assume some primitives add and square for the example:

add :: Int -> Int -> Int
add x y = x + y

square :: Int -> Int
square x = x * x

pythagoras :: Int -> Int -> Int
pythagoras x y = add (square x) (square y)
```

Modified to return a suspended computation, `pythagoras` looks like this:

³ `attoparsec` ^{[^](http://hackage.haskell.org/package/attoparsec-0.10.4.0/docs/Data-Attoparsec-ByteString.html)} <http://hackage.haskell.org/package/attoparsec-0.10.4.0/docs/Data-Attoparsec-ByteString.html> is an example of performance-driven usage of CPS.

Example: A simple module, using continuations

```

-- We assume CPS versions of the add and square primitives,
-- (note: the actual definitions of add_cps and square_cps are not
-- in CPS form, they just have the correct type)

add_cps :: Int -> Int -> ((Int -> r) -> r)
add_cps x y = \k -> k (add x y)

square_cps :: Int -> ((Int -> r) -> r)
square_cps x = \k -> k (square x)

pythagoras_cps :: Int -> Int -> ((Int -> r) -> r)
pythagoras_cps x y = \k ->
  square_cps x $ \x_squared ->
  square_cps y $ \y_squared ->
  add_cps x_squared y_squared $ k

```

How the `pythagoras_cps` example works:

1. square `x` and throw the result into the `(\x_squared -> ...)` continuation
2. square `y` and throw the result into the `(\y_squared -> ...)` continuation
3. add `x_squared` and `y_squared` and throw the result into the top level/program continuation `k`.

We can try it out in GHCi by passing `print` as the program continuation:

```

*Main> pythagoras_cps 3 4 print
25

```

If we look at the type of `pythagoras_cps` without the optional parentheses around `(Int -> r) -> r` and compare it with the original type of `pythagoras`, we note that the continuation was in effect added as an extra argument, thus justifying the "continuation passing style" moniker.

45.2.2 thrice**Example: A simple higher order function, no continuations**

```

thrice :: (a -> a) -> a -> a
thrice f x = f (f (f x))

```

```

*Main> thrice tail "foobar"
"bar"

```

A higher order function such as `thrice`, when converted to CPS, takes as arguments functions in CPS form as well. Therefore, `f :: a -> a` will

`becomef_cps :: a -> ((a -> r) -> r)`, and the final type will be `thrice_cps :: (a -> ((a -> r) -> r)) -> a -> ((a -> r) -> r)`. The rest of the definition follows quite naturally from the types - we replace `f` by the CPS version, passing along the continuation at hand.

Example: A simple higher order function, with continuations

```
thrice_cps :: (a -> ((a -> r) -> r)) -> a -> ((a -> r) -> r)
thrice_cps f_cps x = \k ->
  f_cps x $ \fx ->
  f_cps fx $ \ffx ->
  f_cps ffx $ k
```

45.3 The Cont monad

Having continuation-passing functions, the next step is providing a neat way of composing them, preferably one which does not require the long chains of nested lambdas we have seen just above. A good start would be a combinator for applying a CPS function to a suspended computation. A possible type for it would be:

```
chainCPS :: ((a -> r) -> r) -> (a -> ((b -> r) -> r)) -> ((b -> r) -> r)
```

(You may want to try implementing it before reading on. Hint: start by stating that the result is a function which takes a `b -> r` continuation; then, let the types guide you.)

And here is the implementation:

```
chainCPS s f = \k -> s $ \x -> f x $ k
```

We supply the original suspended computation `s` with a continuation which makes a new suspended computation (produced by `f`) and passes the final continuation `k` to it. Unsurprisingly, it mirrors closely the nested lambda pattern of the previous examples.

Doesn't the type of `chainCPS` look familiar? If we replace `(a -> r) -> r` with `(Monad m) => m a` and `(b -> r) -> r` with `(Monad m) => m b` we get the `(>=)` signature. Furthermore, our old friend `flip ($)` plays a `return`-like role, in that it makes a suspended computation out of a value in a trivial way. Lo and behold, we have a monad! All we need now⁴ is a `Cont r a` type to wrap suspended computations, with the usual wrapper and unwrapper functions.

```
cont :: ((a -> r) -> r) -> Cont r a
runCont :: Cont r a -> (a -> r) -> r
```

The monad instance for `Cont` follows directly from our presentation, the only difference being the wrapping and unwrapping cruft:

```
instance Monad (Cont r) where
```

⁴ Beyond verifying that the monad laws hold, which is left as an exercise to the reader.

```

return x = cont ($ x)
s >>= f = cont $ \c -> runCont s $ \x -> runCont (f x) c

```

The end result is that the monad instance makes the continuation passing (and thus the lambda chains) implicit. The monadic bind applies a CPS function to a suspended computation, and `runCont` is used to provide the final continuation. For a simple example, the Pythagoras example becomes:

Example: The pythagoras example, using the Cont monad

```

-- Using the Cont monad from the transformers package.
import Control.Monad.Trans.Cont

add_cont :: Int -> Int -> Cont r Int
add_cont x y = return (add x y)

square_cont :: Int -> Cont r Int
square_cont x = return (square x)

pythagoras_cont :: Int -> Int -> Cont r Int
pythagoras_cont x y = do
  x_squared <- square_cont x
  y_squared <- square_cont y
  add_cont x_squared y_squared

```

45.4 callCC

While it is always pleasant to see a monad coming forth naturally, a hint of disappointment might linger at this point. One of the promises of CPS was precise control flow manipulation through continuations. And yet, after converting our functions to CPS we promptly hid the continuations behind a monad. To rectify that, we shall introduce `callCC`, a function which gives us back explicit control of continuations - but only where we want it.

`callCC` is a very peculiar function; one that is best introduced with examples. Let us start with a trivial one:

Example: square using callCC

```

-- Without callCC
square :: Int -> Cont r Int
square n = return (n ^ 2)

-- With callCC
squareCCC :: Int -> Cont r Int
squareCCC n = callCC $ \k -> k (n ^ 2)

```

The argument passed to `callCC` is a function, whose result is a suspended computation (general type `Cont r a`) which we will refer to as "the `callCC` computation". *In principle*, the `callCC` computation is what the whole `callCC` expression evaluates to. The caveat, and what makes `callCC` so special, is due to `k`, the argument to the argument. It is a function which acts as an *eject button*: calling it anywhere will lead to the value passed to it being made into a suspended computation, which then is inserted into control flow at the point of the `callCC` invocation. That happens unconditionally; in particular, whatever follows a `k` invocation in the `callCC` computation is summarily discarded. From another perspective, `k` captures *the rest of the computation* following the `callCC`; calling it throws a value into the continuation at that particular point ("callCC" stands for "call with current continuation"). While in this simple example the effect is merely that of a plain `return`, `callCC` opens up a number of possibilities, which we are now going to explore.

45.4.1 Deciding when to use `k`

`callCC` gives us extra power over what is thrown into a continuation, and when that is done. The following example begins to show how we can use this extra power.

Example: Our first proper `callCC` function

```
foo :: Int -> Cont r String
foo x = callCC $ \k -> do
  let y = x ^ 2 + 3
      when (y > 20) $ k "over twenty"
  return (show $ y - 4)
```

`foo` is a slightly pathological function that computes the square of its input and adds three; if the result of this computation is greater than 20, then we return from the `callCC` computation (and, in this case, from the whole function) immediately, throwing the string "over twenty" into the continuation that will be passed to `foo`. If not, then we subtract four from our previous computation, `show` it, and throw it into the continuation. Remarkably, `k` here is used just like the 'return' *statement* from an imperative language, that immediately exits the function. And yet, this being Haskell, `k` is just an ordinary first-class function, so you can pass it to other functions like `when`, store it in a `Reader`, etc.

Naturally, you can embed calls to `callCC` within `do`-blocks:

Example: More developed `callCC` example involving a `do`-block

```
bar :: Char -> String -> Cont r Int
bar c s = do
  msg <- callCC $ \k -> do
    let s0 = c : s
        when (s0 == "hello") $ k "They say hello."
    let s1 = show s0
        return ("They appear to be saying " ++ s1)
  return (length msg)
```

When you call `k` with a value, the entire `callCC` call takes that value. In effect, that makes `k` a lot like an 'goto' statement in other languages: when we call `k` in our example, it pops the execution out to where you first called `callCC`, the `msg <- callCC $...` line. No more of the argument to `callCC` (the inner do-block) is executed. Hence the following example contains a useless line:

Example: Popping out a function, introducing a useless line

```
quux :: Cont r Int
quux = callCC $ \k -> do
  let n = 5
      k n
  return 25
```

`quux` will return 5, and not 25, because we pop out of `quux` before getting to the `return 25` line.

45.4.2 Behind the scenes

We have deliberately broken a trend here: normally when we introduce a function we give its type straight away, but in this case we chose not to. The reason is simple: the type is pretty complex, and it does not immediately give insight into what the function does, or how it works. After the initial presentation of `callCC`, however, we are in a better position to tackle it. Take a deep breath...

```
callCC :: ((a -> Cont r b) -> Cont r a) -> Cont r a
```

We can make sense of that based on what we already know about `callCC`. The overall result type and the result type of the argument have to be the same (i.e. `Cont r a`), as in the absence of an invocation of `k` the corresponding result values are one and the same. Now, what about the type of `k`? As mentioned above, `k`'s argument is made into a suspended computation inserted at the point of the `callCC` invocation; therefore, if the latter has type `Cont r a` `k`'s argument must have type `a`. As for `k`'s result type, interestingly enough it doesn't matter as long as it is wrapped in the same `Cont r` monad; in other words, the `b` stands for an arbitrary type. That happens because the suspended computation made out of the `a` argument will receive whatever continuation follows the `callCC`, and so the continuation taken by `k`'s result is irrelevant.

Note:

The arbitrariness of `k`'s result type explains why the following variant of the useless line example leads to a type error:

```
quux :: Cont r Int
quux = callCC $ \k -> do
  let n = 5
      when True $ k n
      k 25
```

`k`'s result type *could* be anything of form `Cont r a`; however, the `when` constrains it to `Cont r ()`, and so the closing `k 25` does not match the result type of `quux`. The solution is very simple: replace the final `k` by a plain old `return`.

To conclude this section, here is the implementation of `callCC`. Can you identify `k` in it?

```
callCC f = cont $ \h -> runCont (f (\a -> cont $ \_ -> h a)) h
```

Though the code is far from obvious, an amazing fact is that the implementations of `callCC`, `return` and `(>>=)` for `Cont` can be produced automatically from their type signatures - Lennart Augustsson's Djinn <http://lambda-the-ultimate.org/node/1178> is a program that will do this for you. See Phil Gossett's Google tech talk: <http://www.youtube.com/watch?v=h00kptwfX4g> for background on the theory behind Djinn; and Dan Piponi's article: <http://www.haskell.org/wikiupload/1/14/TMR-Issue6.pdf> which uses Djinn in deriving continuation passing style.

45.5 Example: a complicated control structure

We will now look at some more realistic examples of control flow manipulation. The first one, presented below, was originally taken from the "The Continuation monad" section of the All about monads tutorial⁵, used with permission.

⁵ http://www.haskell.org/haskellwiki/All_about_monads

Example: Using Cont for a complicated control structure

*{- We use the continuation monad to perform "escapes" from code blocks.
This function implements a complicated control structure to process
numbers:*

<i>Input (n)</i>	<i>Output</i>	<i>List Shown</i>
<i>0-9</i>	<i>n</i>	<i>none</i>
<i>10-199</i>	<i>number of digits in (n/2)</i>	<i>digits of (n/2)</i>
<i>200-19999</i>	<i>n</i>	<i>digits of (n/2)</i>
<i>20000-1999999</i>	<i>(n/2) backwards</i>	<i>none</i>
<i>>= 2000000</i>	<i>sum of digits of (n/2)</i>	<i>digits of (n/2)</i>

```

-}
fun :: Int -> String
fun n = (`runCont` id) $ do
  str <- callCC $ \exit1 -> do
    -- define "exit1"
    when (n < 10) (exit1 (show n))
    let ns = map digitToInt (show (n `div` 2))
        n' <- callCC $ \exit2 -> do
          -- define "exit2"
          when ((length ns) < 3) (exit2 (length ns))
          when ((length ns) < 5) (exit2 n)
          when ((length ns) < 7) $ do
            let ns' = map intToDigit (reverse ns)
                exit1 (dropWhile (=='0') ns')
            --escape 2 levels
            return $ sum ns
          return $ "(ns = " ++ (show ns) ++ ") " ++ (show n')
    return $ "Answer: " ++ str

```

`fun` is a function that takes an integer `n`. The implementation uses `Cont` and `callCC` to set up a control structure using `Cont` and `callCC` that does different things based on the range that `n` falls in, as stated by the comment at the top. Let us dissect it:

1. Firstly, the `(`runCont` id)` at the top just means that we run the `Cont` block that follows with a final continuation of `id` (or, in other words, we extract the value from the suspended computation unchanged). That is necessary as the result type of `fun` doesn't mention `Cont`.
2. We bind `str` to the result of the following `callCC` do-block:
 - a) If `n` is less than 10, we exit straight away, just showing `n`.
 - b) If not, we proceed. We construct a list, `ns`, of digits of `n `div` 2`.
 - c) `n'` (an `Int`) gets bound to the result of the following inner `callCC` do-block.
 - i. If `length ns < 3`, i.e., if `n `div` 2` has less than 3 digits, we pop out of this inner do-block with the number of digits as the result.
 - ii. If `n `div` 2` has less than 5 digits, we pop out of the inner do-block returning the original `n`.

- iii. If `n `div` 2` has less than 7 digits, we pop out of *both* the inner and outer do-blocks, with the result of the digits of `n `div` 2` in reverse order (a `String`).
 - iv. Otherwise, we end the inner do-block, returning the sum of the digits of `n `div` 2`.
 - d) We end this do-block, returning the `String "(ns = X) Y"`, where `X` is `ns`, the digits of `n `div` 2`, and `Y` is the result from the inner do-block, `n'`.
3. Finally, we return out of the entire function, with our result being the string "Answer: Z", where `Z` is the string we got from the `callCC` do-block.

45.6 Example: exceptions

One use of continuations is to model exceptions. To do this, we hold on to *two* continuations: one that takes us out to the handler in case of an exception, and one that takes us to the post-handler code in case of a success. Here's a simple function that takes two numbers and does integer division on them, failing when the denominator is zero.

Example: An exception-throwing `div`

```
divExcpt :: Int -> Int -> (String -> Cont r Int) -> Cont r Int
divExcpt x y handler = callCC $ \ok -> do
  err <- callCC $ \notOk -> do
    when (y == 0) $ notOk "Denominator 0"
    ok $ x `div` y
  handler err

{- For example,
runCont (divExcpt 10 2 error) id --> 5
runCont (divExcpt 10 0 error) id --> *** Exception: Denominator 0
-}
```

How does it work? We use two nested calls to `callCC`. The first labels a continuation that will be used when there's no problem. The second labels a continuation that will be used when we wish to throw an exception. If the denominator isn't 0, `x `div` y` is thrown into the `ok` continuation, so the execution pops right back out to the top level of `divExcpt`. If, however, we were passed a zero denominator, we throw an error message into the `notOk` continuation, which pops us out to the inner do-block, and that string gets assigned to `err` and given to `handler`.

A more general approach to handling exceptions can be seen with the following function. Pass a computation as the first parameter (more precisely, a function which takes an error-throwing function and results in the computation) and an error handler as the second parameter. This example takes advantage of the generic `MonadCont` class⁶ which covers both

⁶ Found in the `mtl` package, module `Control.Monad.Cont` [^](http://hackage.haskell.org/packages/archive/mtl/2.1.2/doc/html/Control-Monad-Cont.html){<http://hackage.haskell.org/packages/archive/mtl/2.1.2/doc/html/Control-Monad-Cont.html>} .

`Cont` and the corresponding `ContT` transformer by default, as well as any other continuation monad which instantiates it.

Example: General try using continuations.

```
import Control.Monad.Cont

tryCont :: MonadCont m => ((err -> m a) -> m a) -> (err -> m a) -> m a
tryCont c h = callCC $ \ok -> do
  err <- callCC $ \notOk -> do
    x <- c notOk
    ok x
  h err
```

And here is our `try` in action:

Example: Using try

```
data SqrtException = LessThanZero deriving (Show, Eq)

sqrtIO :: (SqrtException -> ContT r IO ()) -> ContT r IO ()
sqrtIO throw = do
  ln <- lift (putStr "Enter a number to sqrt: " >> readLn)
  when (ln < 0) (throw LessThanZero)
  lift $ print (sqrt ln)

main = runContT (tryCont sqrtIO (lift . print)) return
```

In this example, error throwing means escaping from an enclosing `callCC`. The `throw` in `sqrtIO` jumps out of `tryCont`'s inner `callCC`.

45.7 Example: coroutines

In this section we make a `CoroutineT` monad that provides a monad with `fork`, which enqueues a new suspended coroutine, and `yield`, that suspends the current thread.

```
{-# LANGUAGE GeneralizedNewtypeDeriving #-}
-- We use GeneralizedNewtypeDeriving to avoid boilerplate. As of GHC 7.8, it is
safe.

import Control.Applicative
import Control.Monad.Cont
import Control.Monad.State

-- The CoroutineT monad is just ContT stacked with a StateT containing the
suspended coroutines.
newtype CoroutineT r m a = CoroutineT {runCoroutineT' :: ContT r (StateT
[CoroutineT r m ()] m) a}
  deriving (Functor, Applicative, Monad, MonadCont, MonadIO)
```

```

-- Used to manipulate the coroutine queue.
getCCs :: Monad m => CoroutineT r m [CoroutineT r m ()]
getCCs = CoroutineT $ lift get

putCCs :: Monad m => [CoroutineT r m ()] -> CoroutineT r m ()
putCCs = CoroutineT . lift . put

-- Pop and push coroutines to the queue.
dequeue :: Monad m => CoroutineT r m ()
dequeue = do
  current_ccs <- getCCs
  case current_ccs of
    [] -> return ()
    (p:ps) -> do
      putCCs ps
      p

queue :: Monad m => CoroutineT r m () -> CoroutineT r m ()
queue p = do
  ccs <- getCCs
  putCCs (ccs++[p])

-- The interface.
yield :: Monad m => CoroutineT r m ()
yield = callCC $ \k -> do
  queue (k ())
  dequeue

fork :: Monad m => CoroutineT r m () -> CoroutineT r m ()
fork p = callCC $ \k -> do
  queue (k ())
  p
  dequeue

-- Exhaust passes control to suspended coroutines repeatedly until there isn't
  any left.
exhaust :: Monad m => CoroutineT r m ()
exhaust = do
  exhausted <- null <$> getCCs
  if not exhausted
    then yield >> exhaust
    else return ()

-- Runs the coroutines in the base monad.
runCoroutineT :: Monad m => CoroutineT r m r -> m r
runCoroutineT = flip evalStateT [] . flip runContT return . runCoroutineT' . (<*
  exhaust)

```

Some example usage:

```

printOne n = do
  liftIO (print n)
  yield

example = runCoroutineT $ do
  fork $ replicateM_ 3 (printOne 3)
  fork $ replicateM_ 4 (printOne 4)
  replicateM_ 2 (printOne 2)

```

Outputting:

```

3
4
3
2
4

```

3
2
4
4

45.8 Example: Implementing pattern matching

An interesting usage of CPS functions is to implement our own pattern matching. We will illustrate how this can be done by some examples.

Example: Built-in pattern matching

```
check :: Bool -> String
check b = case b of
  True  -> "It's True"
  False -> "It's False"
```

Now we have learnt CPS, we can refactor the code like this.

Example: Pattern matching in CPS

```
type BoolCPS r = r -> r -> r

true :: BoolCPS r
true x _ = x

false :: BoolCPS r
false _ x = x

check :: BoolCPS String -> String
check b = b "It's True" "It's False"
```

```
*Main> check true
"It's True"
*Main> check false
"It's False"
```

What happens here is that, instead of plain values, we represent `True` and `False` by functions that would choose either the first or second argument they are passed. Since `true` and `false` behave differently, we can achieve the same effect as pattern matching. Furthermore, `True`, `False` and `true`, `false` can be converted back and forth by `\b -> b True False` and `\b -> if b then true else false`.

We should see how this is related to CPS in this more complicated example.

Example: More complicated pattern matching and its CPS equivalence

```

data Foobar = Zero | One Int | Two Int Int

type FoobarCPS r = r -> (Int -> r) -> (Int -> Int -> r) -> r

zero :: FoobarCPS r
zero x _ _ = x

one :: Int -> FoobarCPS r
one x _ f _ = f x

two :: Int -> Int -> FoobarCPS r
two x y _ _ f = f x y

fun :: Foobar -> Int
fun x = case x of
  Zero -> 0
  One a -> a + 1
  Two a b -> a + b + 2

funCPS :: FoobarCPS Int -> Int
funCPS x = x 0 (+1) (\a b -> a + b + 2)

```

```

*Main> fun Zero
0
*Main> fun $ One 3
4
*Main> fun $ Two 3 4
9
*Main> funCPS zero
0
*Main> funCPS $ one 3
4
*Main> funCPS $ two 3 4
9

```

Similar to former example, we represent values by functions. These function-values pick the corresponding (i.e. match) continuations they are passed to and pass to the latter the values stored in the former. An interesting thing is that this process involves in no comparison. As we know, pattern matching can work on types that are not instances of Eq: the function-values "know" what their patterns are and would automatically pick the right continuations. If this is done from outside, say, by an `pattern_match :: [(pattern, result)] -> value -> result` function, it would have to inspect and compare the patterns and the values to see if they match -- and thus would need Eq instances.

46 Zippers

46.1 Theseus and the Zipper

46.1.1 The Labyrinth

"Theseus, we have to do something" said Homer, chief marketing officer of Ancient Geeks Inc.. Theseus put the Minotaur action figure™ back onto the shelf and nodded. "Today's children are no longer interested in the ancient myths, they prefer modern heroes like Spiderman or Sponge Bob." *Heroes*. Theseus knew well how much he had been a hero in the labyrinth back then on Crete¹. But those "modern heroes" did not even try to appear realistic. What made them so successful? Anyway, if the pending sales problems could not be resolved, the shareholders would certainly arrange a passage over the Styx for Ancient Geeks Inc.

"Heureka! Theseus, I have an idea: we implement your story with the Minotaur as a computer game! What do you say?" Homer was right. There had been several books, epic (and chart breaking) songs, a mandatory movie trilogy and uncountable Theseus & the Minotaur™ gimmicks, but a computer game was missing. "Perfect, then. Now, Theseus, your task is to implement the game".

A true hero, Theseus chose Haskell as the language to implement the company's redeeming product in. Of course, exploring the labyrinth of the Minotaur was to become one of the game's highlights. He pondered: "We have a two-dimensional labyrinth whose corridors can point in many directions. Of course, we can abstract from the detailed lengths and angles: for the purpose of finding the way out, we only need to know how the path forks. To keep things easy, we model the labyrinth as a tree. This way, the two branches of a fork cannot join again when walking deeper and the player cannot go round in circles. But I think there is enough opportunity to get lost; and this way, if the player is patient enough, they can explore the entire labyrinth with the left-hand rule."

```
data Node a = DeadEnd a
            | Passage a (Node a)
            | Fork    a (Node a) (Node a)
```

¹ Ian Stewart. *The true story of how Theseus found his way out of the labyrinth*. Scientific American, February 1991, page 137.

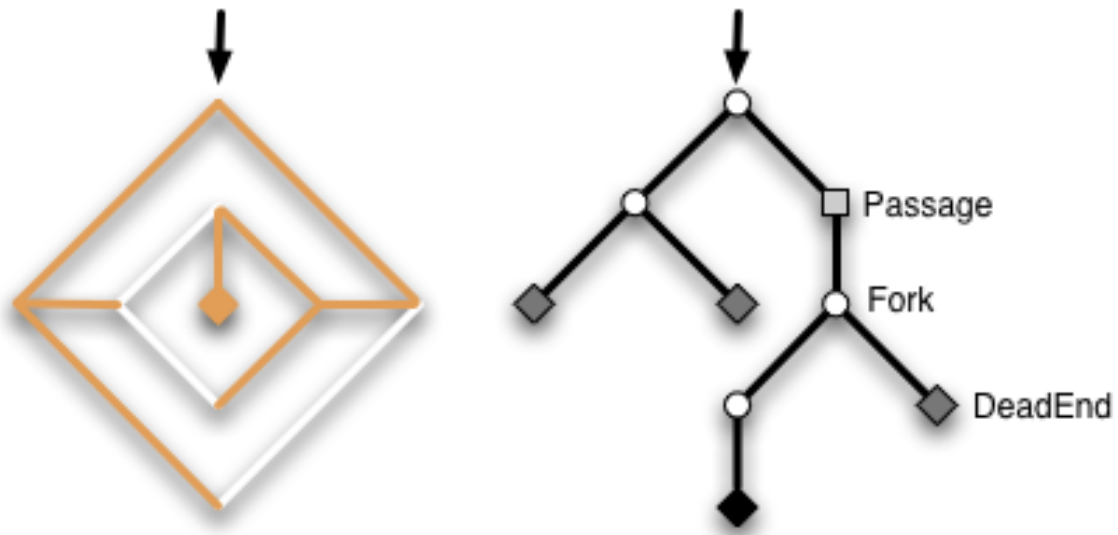

Figure 14 An example labyrinth and its representation as tree.

Theseus made the nodes of the labyrinth carry an extra parameter of type `a`. Later on, it may hold game relevant information like the coordinates of the spot a node designates, the ambience around it, a list of game items that lie on the floor, or a list of monsters wandering in that section of the labyrinth. We assume that two helper functions

```
get :: Node a -> a
put :: a -> Node a -> Node a
```

retrieve and change the value of type `a` stored in the first argument of every constructor of `Node a`.

Exercises:

1. Implement `get` and `put`. One case for `get` is `get (Passage x _) = x`.
2. To get a concrete example, write down the labyrinth shown in the picture as a value of type `Node (Int,Int)`. The extra parameter `(Int,Int)` holds the cartesian coordinates of a node.

”Mh, how to represent the player's current position in the labyrinth? The player can explore deeper by choosing left or right branches, like in”

```
turnRight :: Node a -> Maybe (Node a)
turnRight (Fork _ l r) = Just r
turnRight _           = Nothing
```

”But replacing the current top of the labyrinth with the corresponding sub-labyrinth this way is not an option, because the player cannot go back then.” He pondered. ”Ah, we can apply *Ariadne's trick with the thread* for going back. We simply represent the player's

position by the list of branches their thread takes, the labyrinth always remains the same.”

```
data Branch = KeepStraightOn
           | TurnLeft
           | TurnRight
type Thread = [Branch]
```

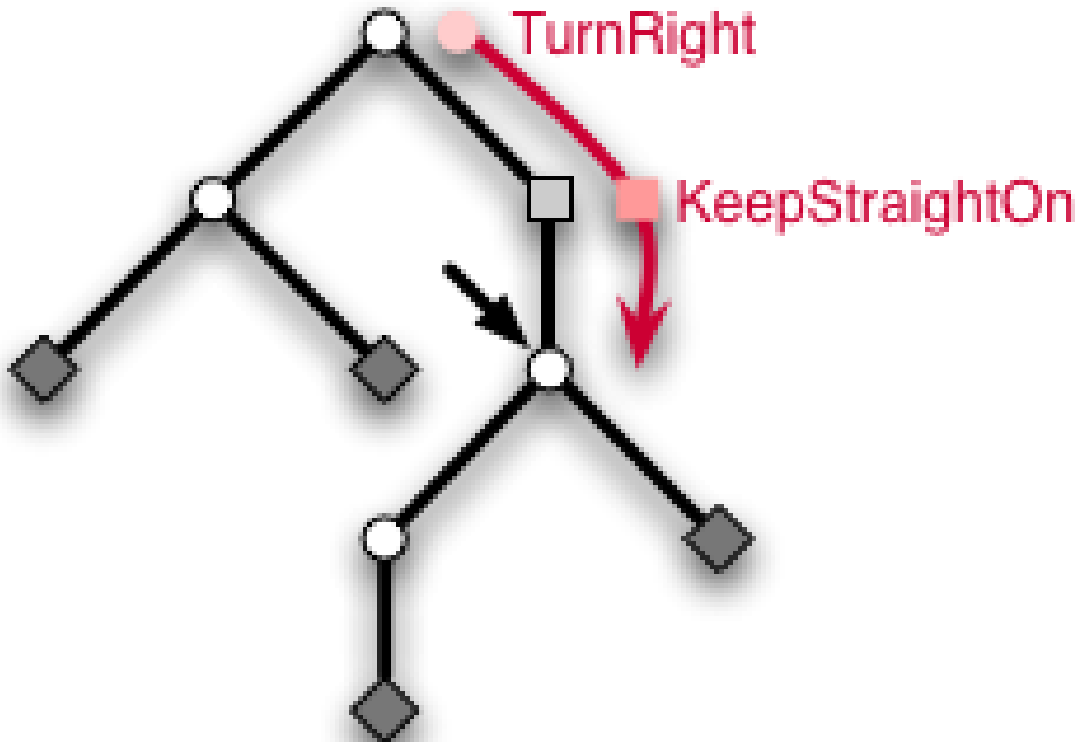

Figure 15 Representation of the player's position by Ariadne's thread.

”For example, a thread `[TurnRight,KeepStraightOn]` means that the player took the right branch at the entrance and then went straight down a `Passage` to reach its current position. With the thread, the player can now explore the labyrinth by extending or shortening it. For instance, the function `turnRight` extends the thread by appending the `TurnRight` to it.”

```
turnRight :: Thread -> Thread
turnRight t = t ++ [TurnRight]
```

”To access the extra data, i.e. the game relevant items and such, we simply follow the thread into the labyrinth.”

```

retrieve :: Thread -> Node a -> a
retrieve []         n           = get n
retrieve (KeepStraightOn:bs) (Passage _ n) = retrieve bs n
retrieve (TurnLeft      :bs) (Fork _ l r)  = retrieve bs l
retrieve (TurnRight     :bs) (Fork _ l r)  = retrieve bs r

```

Exercises:

Write a function `update` that applies a function of type `a -> a` to the extra data at the player's position.

Theseus' satisfaction over this solution did not last long. "Unfortunately, if we want to extend the path or go back a step, we have to change the last element of the list. We could store the list in reverse, but even then, we have to follow the thread again and again to access the data in the labyrinth at the player's position. Both actions take time proportional to the length of the thread and for large labyrinths, this will be too long. Isn't there another way?"

46.1.2 Ariadne's Zipper

While Theseus was a skillful warrior, he did not train much in the art of programming and could not find a satisfying solution. After intense but fruitless cogitation, he decided to call his former love Ariadne to ask her for advice. After all, it was she who had the idea with the thread. Ariadne Consulting. What can I do for you? Our hero immediately recognized the voice. "Hello Ariadne, it's Theseus." An uneasy silence paused the conversation. Theseus remembered well that he had abandoned her on the island of Naxos and knew that she would not appreciate his call. But Ancient Geeks Inc. was on the road to Hades and he had no choice. "Uhm, darling, ... how are you?" Ariadne retorted an icy response, Mr. Theseus, the times of *darling* are long over. What do you want? "Well, I uhm ... I need some help with a programming problem. I'm programming a new Theseus & the Minotaur™ computer game." She jeered, Yet another artifact to glorify your 'heroic being'? And you want me of all people to help you? "Ariadne, please, I beg of you, Ancient Geeks Inc. is on the brink of insolvency. The game is our last hope!" After a pause, she came to a decision. Fine, I will help you. But only if you transfer a substantial part of Ancient Geeks Inc. to me. Let's say thirty percent. Theseus turned pale. But what could he do? The situation was desperate enough, so he agreed but only after negotiating Ariadne's share to a tenth.

After Theseus told Ariadne of the labyrinth representation he had in mind, she could immediately give advice, You need a **zipper**. "Huh? What does the problem have to do with my fly?" Nothing, it's a data structure first published by Gérard Huet². "Ah." More precisely, it's a purely functional way to augment tree-like data structures like lists or binary trees with a single **focus** or **finger** that points to a subtree inside the data structure and allows constant time updates and lookups at the spot it points to³. In our

2 Gérard Huet. *The Zipper*. Journal of Functional Programming, 7 (5), Sept 1997, pp. 549--554. PDF <http://www.st.cs.uni-sb.de/edu/seminare/2005/advanced-fp/docs/huet-zipper.pdf>

3 Note the notion of *zipper* as coined by Gérard Huet also allows to replace whole subtrees even if there is no extra data associated with them. In the case of our labyrinth, this is irrelevant. We will come back to this in the section Differentiation of data types [Chapter 46.2 on page 340](#).

case, we want a focus on the player's position. "I know for myself that I want fast updates, but how do I code it?" Don't get impatient, you cannot solve problems by coding, you can only solve them by thinking. The only place where we can get constant time updates in a purely functional data structure is the topmost node⁴⁵. So, the focus necessarily has to be at the top. Currently, the topmost node in your labyrinth is always the entrance, but your previous idea of replacing the labyrinth by one of its sub-labyrinths ensures that the player's position is at the topmost node. "But then, the problem is how to go back, because all those sub-labyrinths get lost that the player did not choose to branch into." Well, you can use my thread in order not to lose the sub-labyrinths. Ariadne savored Theseus' puzzlement but quickly continued before he could complain that he already used Ariadne's thread, The key is to *glue the lost sub-labyrinths to the thread* so that they actually don't get lost at all. The intention is that the thread and the current sub-labyrinth complement one another to the whole labyrinth. With 'current' sub-labyrinth, I mean the one that the player stands on top of. The zipper simply consists of the thread and the current sub-labyrinth.

```
type Zipper a = (Thread a, Node a)
```

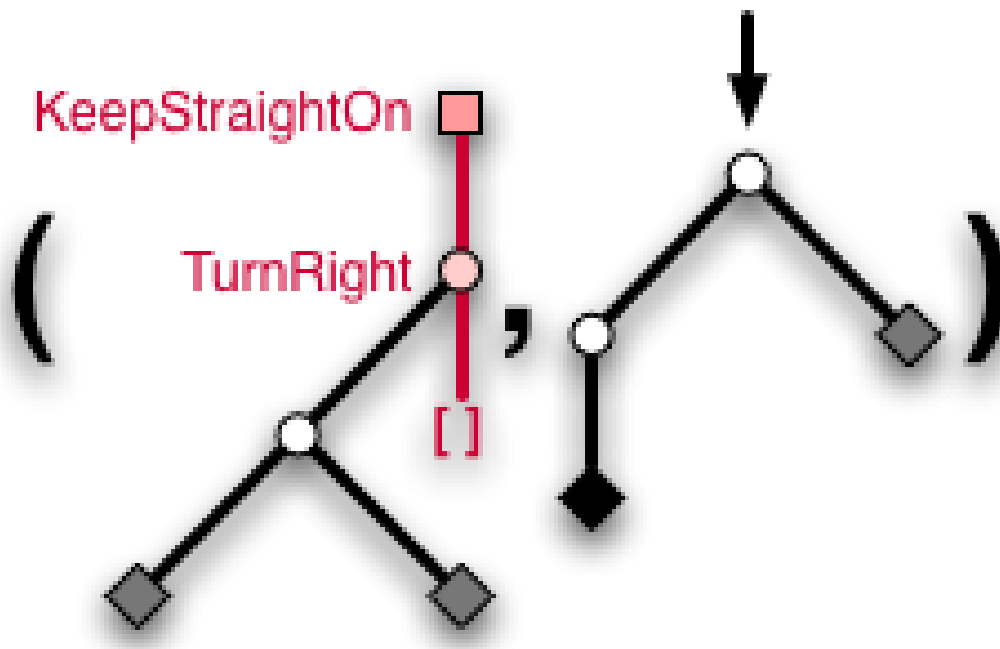

Figure 16 The zipper is a pair of Ariadne's thread and the current sub-labyrinth that the player stands on top. The main thread is colored red and has sub-labyrinths attached to it, such that the whole labyrinth can be reconstructed from the pair.

4 Of course, the second topmost node or any other node at most a constant number of links away from the top will do as well.

5 Note that changing the whole data structure as opposed to updating the data at a node can be achieved in amortized constant time even if more nodes than just the top node is affected. An example is incrementing a number in binary representation. While incrementing say $111 \dots 11$ must touch all digits to yield $1000 \dots 00$, the increment function nevertheless runs in constant amortized time (but not in constant worst case time).

Theseus didn't say anything. You can also view the thread as a **context** in which the current sub-labyrinth resides. Now, let's find out how to define `Thread a`. By the way, `Thread` has to take the extra parameter `a` because it now stores sub-labyrinths. The thread is still a simple list of branches, but the branches are different from before.

```
data Branch a = KeepStraightOn a
              | TurnLeft a (Node a)
              | TurnRight a (Node a)
type Thread a = [Branch a]
```

Most importantly, `TurnLeft` and `TurnRight` have a sub-labyrinth glued to them. When the player chooses say to turn right, we extend the thread with a `TurnRight` and now attach the untaken left branch to it, so that it doesn't get lost. Theseus interrupts, "Wait, how would I implement this behavior as a function `turnRight`? And what about the first argument of type `a` for `TurnRight`? Ah, I see. We not only need to glue the branch that would get lost, but also the extra data of the `Fork` because it would otherwise get lost as well. So, we can generate a new branch by a preliminary"

```
branchRight (Fork x l r) = TurnRight x l
```

"Now, we have to somehow extend the existing thread with it." Indeed. The second point about the thread is that it is stored *backwards*. To extend it, you put a new branch in front of the list. To go back, you delete the topmost element. "Aha, this makes extending and going back take only constant time, not time proportional to the length as in my previous version. So the final version of `turnRight` is"

```
turnRight :: Zipper a -> Maybe (Zipper a)
turnRight (t, Fork x l r) = Just (TurnRight x l : t, r)
turnRight _                = Nothing
```

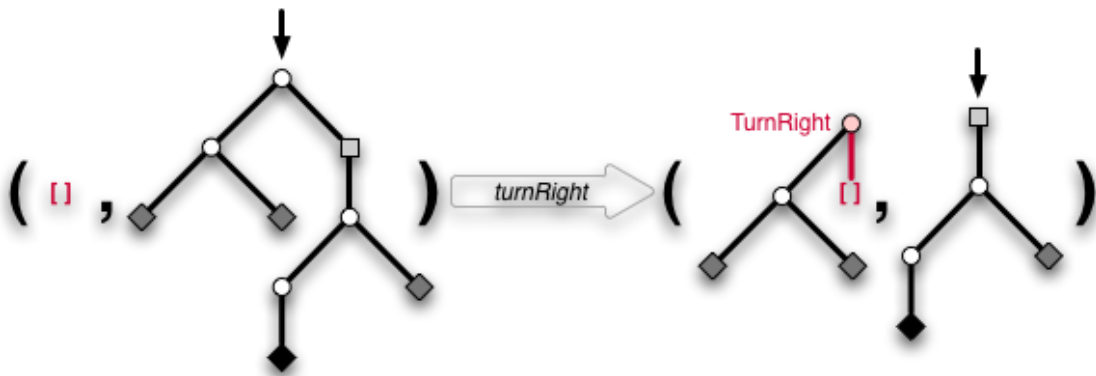

Figure 17 Taking the right subtree from the entrance. Of course, the thread is initially empty. Note that the thread runs backwards, i.e. the topmost segment is the most recent.

"That was not too difficult. So let's continue with `keepStraightOn` for going down a passage. This is even easier than choosing a branch as we only need to keep the extra

data:”

```
keepStraightOn :: Zipper a -> Maybe (Zipper a)
keepStraightOn (t, Passage x n) = Just (KeepStraightOn x : t, n)
keepStraightOn _                = Nothing
```

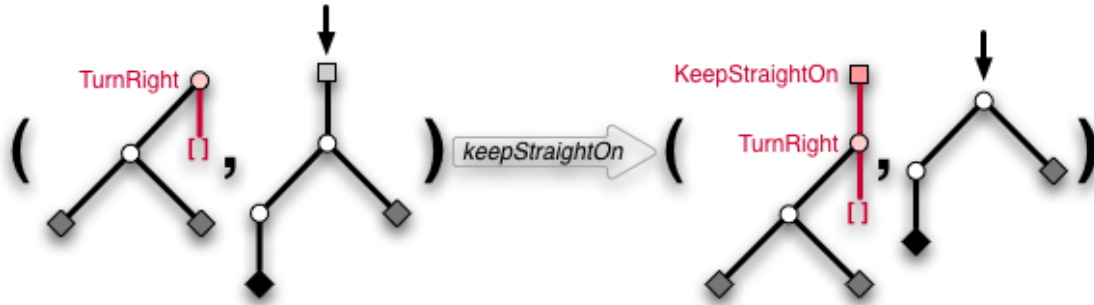

Figure 18 Now going down a passage.

Exercises:

Write the function `turnLeft`.

Pleased, he continued, "But the interesting part is to go back, of course. Let's see..."

```
back :: Zipper a -> Maybe (Zipper a)
back ([ , _) = Nothing
back (KeepStraightOn x : t , n) = Just (t, Passage x n)
back (TurnLeft x r : t , l) = Just (t, Fork x l r)
back (TurnRight x l : t , r) = Just (t, Fork x l r)
```

"If the thread is empty, we're already at the entrance of the labyrinth and cannot go back. In all other cases, we have to wind up the thread. And thanks to the attachments to the thread, we can actually reconstruct the sub-labyrinth we came from." Ariadne remarked, Note that a partial test for correctness is to check that each bound variable like `x`, `l` and `r` on the left hand side appears exactly once at the right hands side as well. So, when walking up and down a zipper, we only redistribute data between the thread and the current sub-labyrinth.

Exercises:

1. Now that we can navigate the zipper, code the functions `get`, `put` and `update` that operate on the extra data at the player's position.
2. Zippers are by no means limited to the concrete example `Node a`, they can be constructed for all tree-like data types. Go on and construct a zipper for binary trees

```
data Tree a = Leaf a | Bin (Tree a) (Tree a)
```

Start by thinking about the possible branches `Branch a` that a thread can take. What do you have to glue to the thread when exploring the tree?

3. Simple lists have a zipper as well.

```
data List a = Empty | Cons a (List a)
```

What does it look like?

4. Write a complete game based on Theseus' labyrinth.

Heureka! That was the solution Theseus sought and Ancient Geeks Inc. should prevail, even if partially sold to Ariadne Consulting. But one question remained: "Why is it called zipper?" Well, I would have called it 'Ariadne's pearl necklace'. But most likely, it's called zipper because the thread is in analogy to the open part and the sub-labyrinth is like the closed part of a zipper. Moving around in the data structure is analogous to zipping or unzipping the zipper. "Ariadne's pearl necklace," he articulated disdainfully. "As if your thread was any help back then on Crete." As if the idea with the thread were yours, she replied. "Bah, I need no thread," he defied the fact that he actually did need the thread to program the game. Much to his surprise, she agreed, Well, indeed you don't need a thread. Another view is to literally grab the tree at the focus with your finger and lift it up in the air. The focus will be at the top and all other branches of the tree hang down. You only have to assign the resulting tree a suitable algebraic data type, most likely that of the zipper.

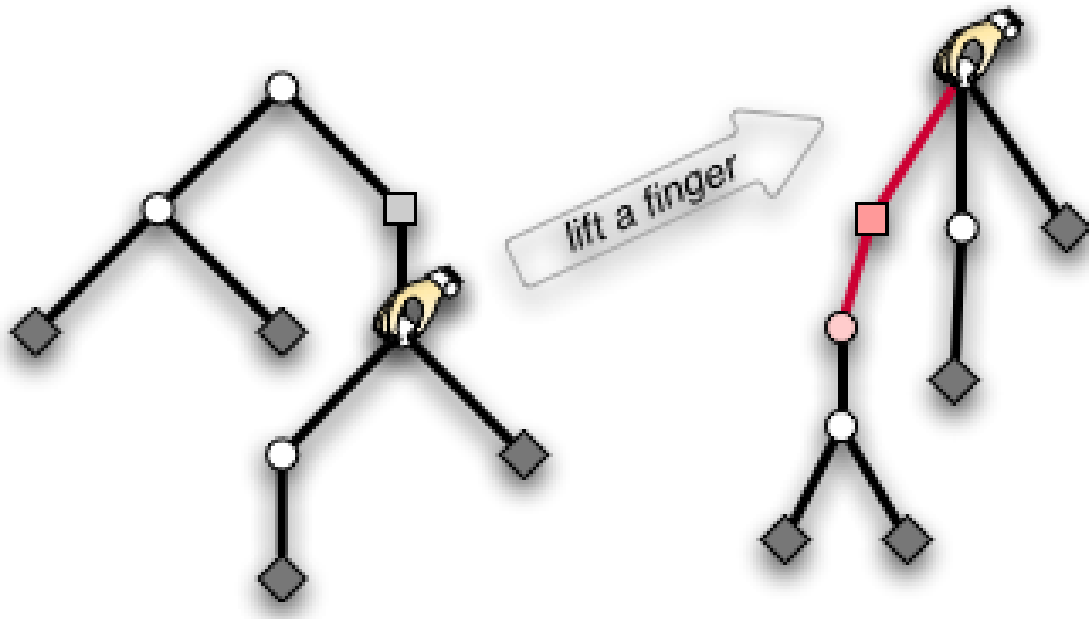

Figure 19 Grab the focus with your finger, lift it in the air and the hanging branches will form new tree with your finger at the top, ready to be structured by an algebraic data type.

"Ah." He didn't need Ariadne's thread but he needed Ariadne to tell him? That was too much. "Thank you, Ariadne, good bye." She did not hide her smirk as he could not see it anyway through the phone.

Exercises:

Take a list, fix one element in the middle with your finger and lift the list into the air. What type can you give to the resulting tree?

Half a year later, Theseus stopped in front of a shop window, defying the cold rain that tried to creep under his buttoned up anorak. Blinking letters announced

"Spider-Man: lost in the Web"

- find your way through the labyrinth of threads -

the great computer game by Ancient Geeks Inc.

He cursed the day when he called Ariadne and sold her a part of the company. Was it she who contrived the unfriendly takeover by WineOS Corp., led by Ariadne's husband Dionysus? Theseus watched the raindrops finding their way down the glass window. After the production line was changed, nobody would produce Theseus and the Minotaur™ merchandise anymore. He sighed. His time, the time of heroes, was over. Now came the super-heroes.

46.2 Differentiation of data types

The previous section has presented the zipper, a way to augment a tree-like data structure `Node a` with a finger that can focus on the different subtrees. While we constructed a zipper for a particular data structure `Node a`, the construction can be easily adapted to different tree data structures by hand.

Exercises:

Start with a ternary tree

```
data Tree a = Leaf a | Node (Tree a) (Tree a) (Tree a)
```

and derive the corresponding `Thread a` and `Zipper a`.

46.2.1 Mechanical Differentiation

But there is also an entirely mechanical way to derive the zipper of any (suitably regular) data type. Surprisingly, 'derive' is to be taken literally, for the zipper can be obtained by the **derivative** of the data type, a discovery first described by Conor McBride⁶. The subsequent section is going to explicate this truly wonderful mathematical gem.

For a systematic construction, we need to calculate with types. The basics of structural calculations with types are outlined in a separate chapter *../Generic Programming*⁷ and we will heavily rely on this material.

Let's look at some examples to see what their zippers have in common and how they hint differentiation. The type of binary tree is the fixed point of the recursive equation

$$Tree2 = 1 + Tree2 \times Tree2$$

When walking down the tree, we iteratively choose to enter the left or the right subtree and then glue the not-entered subtree to Ariadne's thread. Thus, the branches of our thread have the type

$$Branch2 = Tree2 + Tree2 \cong 2 \times Tree2$$

Similarly, the thread for a ternary tree

$$Tree3 = 1 + Tree3 \times Tree3 \times Tree3$$

6 Conor Mc Bride. *The Derivative of a Regular Type is its Type of One-Hole Contexts*. Available online. PDF [^{\{http://strictlypositive.org/diff.pdf\}}](http://strictlypositive.org/diff.pdf)

7 <https://en.wikibooks.org/wiki/..%2FGeneric%20Programming%2F>

has branches of type

$$\text{Branch}3 = 3 \times \text{Tree}3 \times \text{Tree}3$$

because at every step, we can choose between three subtrees and have to store the two subtrees we don't enter. Isn't this strikingly similar to the derivatives $\frac{d}{dx}x^2 = 2 \times x$ and $\frac{d}{dx}x^3 = 3 \times x^2$?

The key to the mystery is the notion of the **one-hole context** of a data structure. Imagine a data structure parameterised over a type X , like the type of trees $\text{Tree}X$. If we were to remove one of the items of this type X from the structure and somehow mark the now empty position, we obtain a structure with a marked hole. The result is called "one-hole context" and inserting an item of type X into the hole gives back a completely filled $\text{Tree}X$. The hole acts as a distinguished position, a focus. The figures illustrate this.

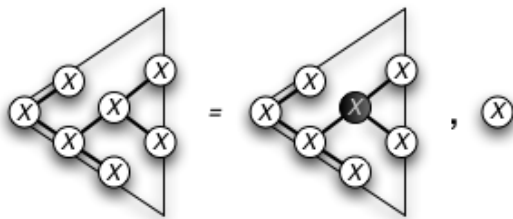

Figure 20 Removing a value of type X from a $\text{Tree}X$ leaves a hole at that position.

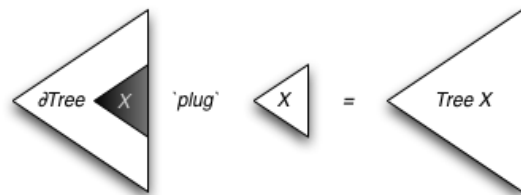
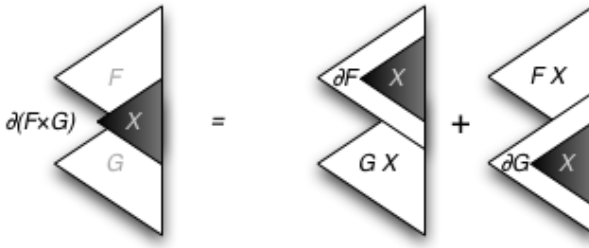
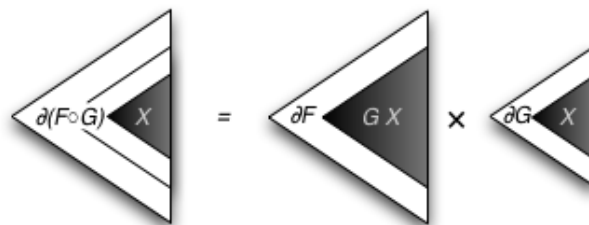

Figure 21 A more abstract illustration of plugging X into a one-hole context.

Of course, we are interested in the type to give to a one-hole context, i.e. how to represent it in Haskell. The problem is how to efficiently mark the focus. But as we will see, finding a representation for one-hole contexts by induction on the structure of the type we want to take the one-hole context of automatically leads to an efficient data type⁸. So, given a data structure $F X$ with a functor F and an argument type X , we want to calculate the type $\partial F X$ of one-hole contexts from the structure of F . As our choice of notation ∂F already reveals, the rules for constructing one-hole contexts of sums, products and compositions are exactly Leibniz' rules for differentiation.

One-hole context		Illustration
$(\partial \text{Const}_A) X$	$= 0$	There is no X in $A = \text{Const}_A X$, so the type of its one-hole contexts must be empty.
$(\partial \text{Id}) X$	$= 1$	There is only one position for items X in $X = \text{Id} X$. Removing one X leaves no X in the result. And as there is only one position we can remove it from, there is exactly one one-hole context for $\text{Id} X$. Thus, the type of one-hole contexts is the singleton type.
$\partial(F + G)$	$= \partial F + \partial G$	As an element of type $F + G$ is either of type F or of type G , a one-hole context is also either ∂F or ∂G .

⁸ This phenomenon already shows up with generic tries.

One-hole context		Illustration
$\partial(F \times G)$	$= F \times \partial G + \partial F \times G$	 <p>Figure 22 The hole in a one-hole context of a pair is either in the first or in the second component.</p>
$\partial(F \circ G)$	$= (\partial F \circ G) \times \partial G$	 <p>Figure 23 Chain rule. The hole in a composition arises by making a hole in the enclosing structure and fitting the enclosed structure in.</p>

Of course, the function `plug` that fills a hole has the type $(\partial F X) \times X \rightarrow F X$.

So far, the syntax ∂ denotes the differentiation of functors, i.e. of a kind of type functions with one argument. But there is also a handy expression oriented notation ∂_X slightly more suitable for calculation. The subscript indicates the variable with respect to which we want to differentiate. In general, we have

$$(\partial F) X = \partial_X(F X)$$

An example is

$$\partial(Id \times Id) X = \partial_X(X \times X) = 1 \times X + X \times 1 \cong 2 \times X$$

Of course, ∂_X is just point-wise whereas ∂ is point-free style.

Exercises:

1. Rewrite some rules in point-wise style. For example, the left hand side of the product rule becomes $\partial_X(F X \times G X) = \dots$
2. To get familiar with one-hole contexts, differentiate the product $X^n := X \times X \times \dots \times X$ of exactly n factors formally and convince yourself that the result is indeed the corresponding one-hole context.
3. Of course, one-hole contexts are useless if we cannot plug values of type X back into them. Write the **plug** functions corresponding to the five rules.
4. Formulate the **chain rule** for **two variables** and prove that it yields one-hole contexts. You can do this by viewing a bifunctor $F X Y$ as an normal functor in the pair (X, Y) . Of course, you may need a handy notation for partial derivatives of bifunctors in point-free style.

46.2.2 Zippers via Differentiation

The above rules enable us to construct **zippers** for recursive data types $\mu F := \mu X. F X$ where F is a polynomial functor. A zipper is a focus on a particular subtree, i.e. substructure of type μF inside a large tree of the same type. As in the previous chapter, it can be represented by the subtree we want to focus at and the thread, that is the context in which the subtree resides

$$Zipper_F = \mu F \times Context_F$$

Now, the context is a series of steps each of which chooses a particular subtree μF among those in $F \mu F$. Thus, the unchosen subtrees are collected together by the one-hole context $\partial F(\mu F)$. The hole of this context comes from removing the subtree we've chosen to enter. Putting things together, we have

$$Context_F = List(\partial F(\mu F))$$

or equivalently

$$Context_F = 1 + \partial F(\mu F) \times Context_F$$

To illustrate how a concrete calculation proceeds, let's systematically construct the zipper for our labyrinth data type

```

data Node a = DeadEnd a
            | Passage a (Node a)
            | Fork a (Node a) (Node a)

```

This recursive type is the fixed point

$$Node\ A = \mu X. NodeF_A\ X$$

of the functor

$$NodeF_A\ X = A + A \times X + A \times X \times X$$

In other words, we have

$$Node\ A \cong NodeF_A(Node\ A) \cong A + A \times Node\ A + A \times Node\ A \times Node\ A$$

The derivative reads

$$\partial_X(NodeF_A\ X) \cong A + 2 \times A \times X$$

and we get

$$\partial NodeF_A(Node\ A) \cong A + 2 \times A \times Node\ A$$

Thus, the context reads

$$Context_{NodeF} \cong List(\partial NodeF_A(Node\ A)) \cong List(A + 2 \times A \times (Node\ A))$$

Comparing with

```

data Branch a = KeepStraightOn a
              | TurnLeft a (Node a)
              | TurnRight a (Node a)
type Thread a = [Branch a]

```

we see that both are exactly the same as expected!

Exercises:

1. Redo the zipper for a ternary tree, but with differentiation this time.
2. Construct the zipper for a list.
3. Rhetorical question concerning the previous exercise: what's the difference between a list and a stack?

46.2.3 Differentiation of Fixed Point

There is more to data types than sums and products, we also have a fixed point operator with no direct correspondence in calculus. Consequently, the table is missing a rule of differentiation, namely how to differentiate fixed points $\mu F X = \mu Y. F X Y$:

$$\partial_X(\mu F X) = ?$$

As its formulation involves the chain rule in two variables, we delegate it to the exercises. Instead, we will calculate it for our concrete example type *Node A*:

$$\begin{aligned} \partial_A(\text{Node } A) &= \partial_A(A + A \times \text{Node } A + A \times \text{Node } A \times \text{Node } A) \\ &\cong 1 + \text{Node } A + \text{Node } A \times \text{Node } A \\ &\quad + \partial_A(\text{Node } A) \times (A + 2 \times A \times \text{Node } A). \end{aligned}$$

Of course, expanding $\partial_A(\text{Node } A)$ further is of no use, but we can see this as a fixed point equation and arrive at

$$\partial_A(\text{Node } A) = \mu X. T A + S A \times X$$

with the abbreviations

$$T A = 1 + \text{Node } A + \text{Node } A \times \text{Node } A$$

and

$$S A = A + 2 \times A \times \text{Node } A$$

The recursive type is like a list with element types SA , only that the empty list is replaced by a base case of type TA . But given that the list is finite, we can replace the base case with 1 and pull TA out of the list:

$$\partial_A(\text{Node } A) \cong TA \times (\mu X. 1 + SA \times X) = TA \times \text{List}(SA)$$

Comparing with the zipper we derived in the last paragraph, we see that the list type is our context

$$\text{List}(SA) \cong \text{Context}_{\text{Node } F}$$

and that

$$A \times TA \cong \text{Node } A$$

In the end, we have

$$\text{Zipper}_{\text{Node } F} \cong \partial_A(\text{Node } A) \times A$$

Thus, differentiating our concrete example $\text{Node } A$ with respect to A yields the zipper up to an A !

Exercises:

1. Use the chain rule in two variables to formulate a rule for the differentiation of a fixed point.
2. Maybe you know that there are inductive (μ) and coinductive fixed points (ν). What's the rule for coinductive fixed points?

46.2.4 Differentiation with respect to functions of the argument

When finding the type of a one-hole context one does $d f(x)/d x$. It is entirely possible to solve expressions like $d f(x)/d g(x)$. For example, solving $d x^4 / d x^2$ gives $2x^2$, a two-hole context of a 4-tuple. The derivation is as follows let $u=x^2$ $d x^4 / d x^2 = d u^2 / d u = 2u = 2 x^2$.

46.2.5 Zippers vs Contexts

In general however, zippers and one-hole contexts denote different things. The zipper is a focus on arbitrary subtrees whereas a one-hole context can only focus on the argument of a type constructor. Take for example the data type

```
data Tree a = Leaf a | Bin (Tree a) (Tree a)
```

which is the fixed point

$$Tree\ A = \mu X. A + X \times X$$

The zipper can focus on subtrees whose top is `Bin` or `Leaf` but the hole of one-hole context of $Tree\ A$ may only focus a `Leaf`s because this is where the items of type A reside. The derivative of $Node\ A$ only turned out to be the zipper because every top of a subtree is always decorated with an A .

Exercises:

1. Surprisingly, $\partial_A(Tree\ A) \times A$ and the zipper for $Tree\ A$ again turn out to be the same type. Doing the calculation is not difficult but can you give a reason why this has to be the case?
2. Prove that the zipper construction for μF can be obtained by introducing an auxiliary variable Y , differentiating $\mu X. Y \times F\ X$ with respect to it and re-substituting $Y = 1$. Why does this work?
3. Find a type $G\ A$ whose zipper is different from the one-hole context.

46.2.6 Conclusion

We close this section by asking how it may happen that rules from calculus appear in a discrete setting. Currently, nobody knows. But at least, there is a discrete notion of **linear**, namely in the sense of "exactly once". The key feature of the function that plugs an item of type X into the hole of a one-hole context is the fact that the item is used exactly once, i.e. linearly. We may think of the plugging map as having type

$$\partial_X F\ X \rightarrow (X \multimap F\ X)$$

where $A \multimap B$ denotes a linear function, one that does not duplicate or ignore its argument, as in linear logic. In a sense, the one-hole context is a representation of the function space $X \multimap F\ X$, which can be thought of being a linear approximation to $X \rightarrow F\ X$.

46.3 See Also

w:Zipper (data structure)⁹

- Zipper¹⁰ on the haskell.org wiki
- Generic Zipper and its applications¹¹
- Zipper-based file server/OS¹²
- Scrap Your Zippers: A Generic Zipper for Heterogeneous Types¹³

9 <https://en.wikipedia.org/wiki/Zipper%20%28data%20structure%29>

10 <http://www.haskell.org/haskellwiki/Zipper>

11 <http://okmij.org/ftp/Computation/Continuations.html#zipper>

12 <http://okmij.org/ftp/Computation/Continuations.html#zipper-fs>

13 http://www.michaeldadams.org/papers/scrap_your_zippers/

47 Lenses and functional references

This chapter is about *functional references*. By "references", we mean they point at parts of values, allowing us to access and modify them. By "functional", we mean they do so in a way that provides the flexibility and composability we came to expect from functions. We will study functional references as implemented by the powerful `lens`¹ library. `lens` is named after *lenses*, a particularly well known kind of functional reference. Beyond being very interesting from a conceptual point of view, lenses and other functional references allow for several convenient and increasingly common idioms, put into use by a number of useful libraries.

47.1 A taste of lenses

As a warm-up, we will demonstrate the simplest use case for lenses: as a nicer alternative to the vanilla Haskell records. There will be little in the way of explanations in this section; we will fill in the gaps through the remainder of the chapter.

Consider the following types, which are not unlike something you might find in a 2D drawing library:

```
-- A point in the plane.
data Point = Point
  { positionX :: Double
  , positionY :: Double
  } deriving (Show)

-- A line segment from one point to another.
data Segment = Segment
  { segmentStart :: Point
  , segmentEnd   :: Point
  } deriving (Show)

-- Helpers to create points and segments.
makePoint :: (Double, Double) -> Point
makePoint (x, y) = Point x y

makeSegment :: (Double, Double) -> (Double, Double) -> Segment
makeSegment start end = Segment (makePoint start) (makePoint end)
```

Record syntax gives us functions for accessing the fields. With them, getting the coordinates of the points that define a segment is easy enough:

```
GHCi> let testSeg = makeSegment (0, 1) (2, 4)
GHCi> positionY . segmentEnd $ testSeg
GHCi> 4.0
```

1 <https://hackage.haskell.org/package/lens>

Updates, however, are clunkier...

```
GHCi> testSeg { segmentEnd = makePoint (2, 3) }
Segment {segmentStart = Point {positionX = 0.0, positionY = 1.0}
, segmentEnd = Point {positionX = 2.0, positionY = 3.0}}
```

... and get downright ugly when we need to reach a nested field. Here is what it takes to double the value of the *y* coordinate of the end point:

```
GHCi> :set +m -- Enabling multi-line input in GHCi.
GHCi> let end = segmentEnd testSeg
GHCi| in testSeg { segmentEnd = end { positionY = 2 * positionY end } }
Segment {segmentStart = Point {positionX = 0.0, positionY = 1.0}
, segmentEnd = Point {positionX = 2.0, positionY = 8.0}}
```

Lenses allow us to avoid such nastiness, so let's start over with them:

```
-- Some of the examples in this chapter require a few GHC extensions:
-- TemplateHaskell is needed for makeLenses; RankNTypes is needed for
-- a few type signatures later on.
{-# LANGUAGE TemplateHaskell, RankNTypes #-}

import Control.Lens

data Point = Point
  { _positionX :: Double
  , _positionY :: Double
  } deriving (Show)
makeLenses ''Point

data Segment = Segment
  { _segmentStart :: Point
  , _segmentEnd :: Point
  } deriving (Show)
makeLenses ''Segment

makePoint :: (Double, Double) -> Point
makePoint (x, y) = Point x y

makeSegment :: (Double, Double) -> (Double, Double) -> Segment
makeSegment start end = Segment (makePoint start) (makePoint end)
```

The only real change here is the use of `makeLenses`, which automatically generates lenses for the fields of `Point` and `Segment` (the extra underscores are required by the naming conventions of `makeLenses`). As we will see, writing lenses definitions by hand is not difficult at all; however, it can be tedious if there are lots of fields to make lenses for, and thus automatic generation is very convenient.

Thanks to `makeLenses`, we now have a lens for each field. Their names match that of the fields, except with the leading underscore removed:

```
GHCi> :info positionY
positionY :: Lens' Point Double
-- Defined at WikibookLenses.hs:9:1
GHCi> :info segmentEnd
segmentEnd :: Lens' Segment Point
-- Defined at WikibookLenses.hs:15:1
```

The type `positionY :: Lens' Point Double` tells us that `positionY` is a *reference* to a `Double` within a `Point`. To work with such references, we use the combinators provided by

the `lens` library. One of them is `view`, which gives us the value pointed at by a lens, just like a record accessor:

```
GHCi> let testSeg = makeSegment (0, 1) (2, 4)
GHCi> view segmentEnd testSeg
Point {_positionX = 2.0, _positionY = 4.0}
```

Another one is `set`, which overwrites the value pointed at:

```
GHCi> set segmentEnd (makePoint (2, 3)) testSeg
Segment {_segmentStart = Point {_positionX = 0.0, _positionY = 1.0}
, _segmentEnd = Point {_positionX = 2.0, _positionY = 3.0}}
```

One of the great things about lenses is that they are easy to compose:

```
GHCi> view (segmentEnd . positionY) testSeg
GHCi> 4.0
```

Note that when writing composed lenses, such as `segmentEnd . positionY`, the order is from large to small. In this case, the lens that focuses on a point of the segment comes before the one that focuses on a coordinate of that point. While that might look a little surprising in contrast to how record accessors work (compare with the equivalent lens-less example at the beginning of this section), the `(.)` used here is just the function composition operator we know and love.

Composition of lenses provide a way out of the nested record update quagmire. Here is a translation of the coordinate-doubling example using `over`, through which we can apply a function to the value pointed at by a lens:

```
GHCi> over (segmentEnd . positionY) (2 *) testSeg
Segment {_segmentStart = Point {_positionX = 0.0, _positionY = 1.0}
, _segmentEnd = Point {_positionX = 2.0, _positionY = 8.0}}
```

These initial examples might look a bit magical at first. What makes it possible to use one and the same lens to get, set and modify a value? How come composing lenses with `(.)` just works? Is it really so easy to write lenses without the help of `makeLenses`? We will answer such questions by going behind the curtains to find what lenses are made of.

47.2 The scenic route to lenses

There are many ways to make sense of lenses. We will follow a sinuous yet gentle path, one which avoids conceptual leaps of faith. Along the way, we will introduce a few different kinds of functional references. Following `lens` terminology, from now on we will use the word *"optics"* to refer collectively to the various species of functional references. As we will see, the optics in `lens` are interrelated, forming a hierarchy. It is this hierarchy which we are now going to explore.

47.2.1 Traversals

We will begin not with lenses, but with a closely related optic: traversals. The `Traversable`² chapter discussed how `traverse` makes it possible to walk across a structure while producing an overall effect:

```
traverse
  :: (Applicative f, Traversable t) => (a -> f b) -> t a -> f (t b)
```

With `traverse`, you can use any `Applicative` you like to produce the effect. In particular, we have seen how `fmap` can be obtained from `traverse` simply by picking `Identity` as the applicative functor, and that the same goes for `foldMap` and `Const m`, using `Monoid m => Applicative (Const m)`:

```
fmap f = runIdentity . traverse (Identity . f)
foldMap f = getConst . traverse (Const . f)
```

`lens` takes this idea and lets it blossom.

Manipulating values within a `Traversable` structure, as `traverse` allows us to, is an example of targeting parts of a whole. As flexible as it is, however, `traverse` only handles a rather limited range of targets. For one, we might want to walk across structures that are not `Traversable` functors. Here is an entirely reasonable function that does so with our `Point` type:

```
pointCoordinates
  :: Applicative f => (Double -> f Double) -> Point -> f Point
pointCoordinates g (Point x y) = Point <$> g x <*> g y
```

`pointCoordinates` is a *traversal* of `Point`. It looks a lot like a typical implementation of `traverse`, and can be used in pretty much the same way. Here is an adaptation of the `rejectWithNegatives` example from the `Traversable`³ chapter:

```
GHCi> let deleteIfNegative x = if x < 0 then Nothing else Just x
GHCi> pointCoordinates deleteIfNegative (makePoint (1, 2))
Just (Point {_positionX = 1.0, _positionY = 2.0})
GHCi> pointCoordinates deleteIfNegative (makePoint (-1, 2))
Nothing
```

This generalised notion of a traversal that `pointCoordinates` exemplifies is captured by one of the core types of `lens`: `Traversal`.

```
type Traversal s t a b =
  forall f. Applicative f => (a -> f b) -> s -> f t
```

Note:

The `forall f.` on the right side of the type declaration means that any `Applicative` can be used to replace `f`. That makes it unnecessary to mention `f` on the left side, or to specify which `f` to pick when using a `Traversal`.

With the `Traversal` synonym, the type of `pointCoordinates` can be expressed as:

² Chapter 42 on page 283

³ Chapter 42.1 on page 283

```
Traversal Point Point Double Double
```

Let's have a closer look at what became of each type variable in `Traversal s t a b`:

- `s` becomes `Point`: `pointCoordinates` is a traversal of a `Point`.
- `t` becomes `Point`: `pointCoordinates` produces a `Point` (in some `Applicative` context).
- `a` becomes `Double`: `pointCoordinates` targets `Double` values in a `Point` (the X and Y coordinates of the points).
- `b` becomes `Double`: the targeted `Double` values become `Double` values (possibly different than the original ones).

In the case of `pointCoordinates`, `s` is the same as `t`, and `a` is the same as `b`. `pointCoordinates` does not change the type of the traversed structure, or that of the targets in it, but that need not be the case. One example is good old `traverse`, whose type can be expressed as:

```
Traversable t => Traversal (t a) (t b) a b
```

`traverse` is able to change the types of the targeted values in the `Traversable` structure and, by extension, the type of the structure itself.

The `Control.Lens.Traversal4` module includes generalisations of `Data.Traversable5` functions and various other tools for working with traversals.

Exercises:

1. Write `extremityCoordinates`, a traversal that goes through all coordinates of the points that define a `Segment` in the order suggested by the data declaration. (Hint: use the `pointCoordinates` traversal.)

47.2.2 Setters

Next in our programme comes the generalisation of the links between `Traversable`, `Functor` and `Foldable`. We shall begin with `Functor`.

To recover `fmap` from `traverse`, we picked `Identity` as the applicative functor. That choice allowed us to modify the targeted values without producing any extra effects. We can reach similar results by picking the definition of a `Traversal`...

```
forall f. Applicative f => (a -> f b) -> s -> f t
```

... and specialising `f` to `Identity`:

```
(a -> Identity b) -> s -> Identity t
```

⁴ <http://hackage.haskell.org/packages/archive/lens/latest/doc/html/Control-Lens-Traversal.html>

⁵ <http://hackage.haskell.org/packages/archive/base/latest/doc/html/Data-Traversable.html>

In lens parlance, that is how you get a **Setter**. For technical reasons, the definition of **Setter** in `Control.Lens.Setter`⁶ is a little different...

```
type Setter s t a b =  
  forall f. Settable f => (a -> f b) -> s -> f t
```

... but if you dig into the documentation you will find that a **Settable** functor is either **Identity** or something very much like it, so the difference need not concern us.

When we take **Traversal** and restrict the choice of **f** we actually make the type more general. Given that a **Traversal** works with any **Applicative** functor, it will also work with **Identity**, and therefore any **Traversal** is a **Setter** and can be used as one. The reverse, however, is not true: not all setters are traversals.

over is the essential combinator for setters. It works a lot like **fmap**, except that you pass a setter as its first argument in order to specify which parts of the structure you want to target:

```
GHCi> over pointCoordinates negate (makePoint (1, 2))  
Point {_positionX = -1.0, _positionY = -2.0}
```

In fact, there is a **Setter** called **mapped** that allows us to recover **fmap**:

```
GHCi> over mapped negate [1..4]  
[-1,-2,-3,-4]  
GHCi> over mapped negate (Just 3)  
Just (-3)
```

Another very important combinator is **set**, which replaces all targeted values with a constant. **set setter x = over setter (const x)**, analogously to how **(x <\$) = fmap (const x)**:

```
GHCi> set pointCoordinates 7 (makePoint (1, 2))  
Point {_positionX = 7.0, _positionY = 7.0}
```

Exercises:

1. Use **over** to implement...
`scaleSegment :: Double -> Segment -> Segment`
... so that `scaleSegment n` multiplies all coordinates of a segment by `x`. (Hint: use your answer to the previous exercise.)
2. Implement **mapped**. For this exercise, you can specialise the **Settable** functor to **Identity**. (Hint: you will need `Data.Functor.Identity`^a.)

^a <http://hackage.haskell.org/packages/archive/base/latest/doc/html/Data-Functor-Identity.html>

⁶ <http://hackage.haskell.org/packages/archive/lens/latest/doc/html/Control-Lens-Setter.html>

47.2.3 Folds

Having generalised the `fmap-as-traversal` trick, it is time to do the same with the `foldMap-as-traversal` one. We will use `Const` to go from...

```
forall f. Applicative f => (a -> f b) -> s -> f t
```

... to:

```
forall r. Monoid r => (a -> Const r a) -> s -> Const r s
```

Since the second parameter of `Const` is irrelevant, we replace `b` with `a` and `t` with `s` to make our life easier.

Just like we have seen for `Setter` and `Identity`, `Control.Lens.Fold`⁷ uses something slightly more general than `Monoid r => Const r`:

```
type Fold s a =
  forall f. (Contravariant f, Applicative f) => (a -> f a) -> s -> f s
```

⁷ <http://hackage.haskell.org/packages/archive/base/latest/doc/html/Control-Lens-Fold.html>

Note:

`Contravariant` is a type class for *contravariant functors*. The key `Contravariant` method is `contramap`...

```
contramap :: Contravariant f => (a -> b) -> f b -> f a
```

... which looks a lot like `fmap`, except that it, so to say, turns the function arrow around on mapping. Types parametrised over function arguments are typical examples of `Contravariant`. For instance, `Data.Functor.Contravariant`^a defines a `Predicate` type for boolean tests on values of type `a`:

```
newtype Predicate a = Predicate { getPredicate :: a -> Bool }
```

```
GHCi> :m +Data.Functor.Contravariant
```

```
GHCi> let largerThanFour = Predicate (> 4)
```

```
GHCi> getPredicate largerThanFour 6
```

```
True
```

`Predicate` is a `Contravariant`, and so you can use `contramap` to modify a `Predicate` so that the values are adjusted in some way before being submitted to the test:

```
GHCi> getPredicate (contramap length largerThanFour) "orange"
```

```
True
```

`Contravariant` has laws which are analogous to the `Functor` ones:

```
contramap id = id
```

```
contramap (g . f) = contramap f . contramap g
```

^a <http://hackage.haskell.org/packages/archive/contravariant/latest/doc/html/Data-Functor-Contravariant.html>

`Monoid r => Const r` is both a `Contravariant` and an `Applicative`. Thanks to the functor and contravariant laws, anything that is both a `Contravariant` and a `Functor` is, just like `Const r`, a vacuous functor, with both `fmap` and `contramap` doing nothing. The additional `Applicative` constraint corresponds to the `Monoid r`; it allows us to actually perform the fold by combining the `Const`-like contexts created from the targets.

Every `Traversal` can be used as a `Fold`, given that a `Traversal` must work with any `Applicative`, including those that are also `Contravariant`. The situation parallels exactly what we have seen for `Traversal` and `Setter`.

`Control.Lens.Fold` offers analogues to everything in `Data.Foldable`⁸. Two commonly seen combinators from that module are `toListOf`, which produces a list of the `Fold` targets...

```
GHCi> -- Using the solution to the exercise in the traversals subsection.
```

```
GHCi> toListOf extremityCoordinates (makeSegment (0, 1) (2, 3))
```

```
[0.0,1.0,2.0,3.0]
```

⁸ <http://hackage.haskell.org/packages/archive/base/latest/doc/html/Data-Foldable.html>

... and `preview`, which extracts the first target of a `Fold` using the `First` monoid from `Data.Monoid`⁹.

```
GHCi> preview traverse [1..10]
Just 1
```

47.2.4 Getters

So far we have moved from `Traversal` to more general optics (`Setter` and `Fold`) by restricting the functors available for traversing. We can also go in the opposite direction, that is, making more specific optics by broadening the range of functors they have to deal with. For instance, if we take `Fold`...

```
type Fold s a =
  forall f. (Contravariant f, Applicative f) => (a -> f a) -> s -> f s
```

... and relax the `Applicative` constraint to merely `Functor`, we obtain `Getter`:

```
type Getter s a =
  forall f. (Contravariant f, Functor f) => (a -> f a) -> s -> f s
```

As `f` still has to be both `Contravariant` and `Functor`, it remains being a `Const`-like vacuous functor. Without the `Applicative` constraint, however, we can't combine results from multiple targets. The upshot is that a `Getter` always has exactly one target, unlike a `Fold` (or, for that matter, a `Setter`, or a `Traversal`) which can have any number of targets, including zero.

The essence of `Getter` can be brought to light by specialising `f` to the obvious choice, `Const r`:

```
someGetter :: (a -> Const r a) -> s -> Const r s
```

Since a `Const r whatever` value can be losslessly converted to a `r` value and back, the type above is equivalent to:

```
someGetter' :: (a -> r) -> s -> r

someGetter' k x = getConst (someGetter (Const . k) x)
someGetter g x = Const (someGetter' (getConst . g) x)
```

An `(a -> r) -> s -> r` function, however, is just an `s -> a` function in disguise (the camouflage being continuation passing style¹⁰):

```
someGetter'' :: s -> a

someGetter'' x = someGetter' id x
someGetter' k x = k (someGetter'' x)
```

Thus we conclude that a `Getter s a` is equivalent to a `s -> a` function. From this point of view, it is only natural that it takes exactly one target to exactly one result. It is

⁹ <http://hackage.haskell.org/packages/archive/base/latest/doc/html/Data-Monoid.html>

¹⁰ Chapter 45 on page 317

not surprising either that two basic combinators from `Control.Lens.Getter`¹¹ are `to`, which makes a `Getter` out of an arbitrary function, and `view`, which converts a `Getter` back to an arbitrary function.

```
GHCi> -- The same as fst (4, 1)
GHCi> view (to fst) (4, 1)
4
```

Note:

Given what we have just said about `Getter` being less general than `Fold`, it may come as a surprise that `view` can work `Folds` and `Traversals` as well as with `Getters`:

```
GHCi> :m +Data.Monoid
GHCi> view traverse (fmap Sum [1..10])
Sum {getSum = 55}
GHCi> -- both traverses the components of a pair.
GHCi> view both ([1,2],[3,4,5])
[1,2,3,4,5]
```

That is possible thanks to one of the many subtleties of the type signatures of `lens`. The first argument of `view` is not exactly a `Getter`, but a `Getting`:

```
type Getting r s a = (a -> Const r a) -> s -> Const r s
```

```
view :: MonadReader s m => Getting a s a -> m a
```

`Getting` specialises the functor parameter to `Const r`, the obvious choice for `Getter`, but leaves it open whether there will be an `Applicative` instance for it (i.e. whether `r` will be a `Monoid`). Using `view` as an example, as long as `a` is a `Monoid` `Getting a s a` can be used as a `Fold`, and so `Folds` can be used with `view` as long as the fold targets are monoidal.

Many combinators in both `Control.Lens.Getter` and `Control.Lens.Fold` are defined in terms of `Getting` rather than `Getter` or `Fold`. One advantage of using `Getting` is that the resulting type signatures tell us more about the folds that might be performed. For instance, consider `hasn't` from `Control.Lens.Fold`:

```
hasn't :: Getting All s a -> s -> Bool
```

It is a generalised test for emptiness:

```
GHCi> hasn't traverse [1..4]
False
GHCi> hasn't traverse Nothing
True
```

`Fold s a -> s -> Bool` would work just as well as a signature for `hasn't`. However, the `Getting All` in the actual signature is quite informative, in that it strongly suggests what `hasn't` does: it converts all `a` targets in `s` to the `All` monoid (more precisely, to `All False`), folds them and extracts a `Bool` from the overall `All` result.

¹¹ <http://hackage.haskell.org/packages/archive/base/latest/doc/html/Control-Lens-Getter.html>

47.2.5 Lenses at last

If we go back to `Traversal`...

```
type Traversal s t a b =
  forall f. Applicative f => (a -> f b) -> s -> f t
```

... and relax the `Applicative` constraint to `Functor`, just as we did when going from `Fold` to `Getter`...

```
type Lens s t a b =
  forall f. Functor f => (a -> f b) -> s -> f t
```

... we finally reach the `Lens` type.

What changes when moving from `Traversal` to `Lens`? As before, relaxing the `Applicative` constraint costs us the ability to traverse multiple targets. Unlike a `Traversal`, a `Lens` always focuses on a single target. As usual in such cases, there is a bright side to the restriction: with a `Lens`, we can be sure that exactly one target will be found, while with a `Traversal` we might end up with many, or none at all.

The absence of the `Applicative` constraint and the uniqueness of targets point towards another key fact about lenses: they can be used as getters. `Contravariant` plus `Functor` is a strictly more specific constraint than just `Functor`, and so `Getter` is strictly more general than `Lens`. As every `Lens` is also a `Traversal` and therefore a `Setter`, we conclude that *lenses can be used as both getters and setters*. That explains why lenses can replace record labels.

Note:

On close reading, our claim that every `Lens` can be used as a `Getter` might seem rash. Placing the types side by side...

```
type Lens s t a b =
  forall f. Functor f => (a -> f b) -> s -> f t

type Getter s a =
  forall f. (Contravariant f, Functor f) => (a -> f a) -> s -> f s
```

... shows that going from `Lens s t a b` to `Getter s a` involves making `s` equal to `t` and `a` equal to `b`. How can we be sure that is possible for any lens? An analogous issue might be raised about the relationship between `Traversal` and `Fold`. For the moment, this question will be left suspended; we will return to it in the section about optic laws.

Here is a quick demonstration of the flexibility of lenses using `_1`, a lens that focuses on the first component of a tuple:

```
GHCi> _1 (\x -> [0..x]) (4, 1) -- Traversal
[(0,1),(1,1),(2,1),(3,1),(4,1)]
GHCi> set _1 7 (4, 1) -- Setter
(7,1)
GHCi> over _1 length ("orange", 1) -- Setter, changing the types
(6,1)
GHCi> toListOf _1 (4, 1) -- Fold
```

```
[4]
GHCi> view _1 (4, 1) -- Getter
4
```

Exercises:

1. Implement the lenses for the fields of `Point` and `Segment`, that is, the ones we generated with `makeLenses` early on. (Hint: Follow the types. Once you write the signatures down you will notice that beyond `fmap` and the record labels there is not much else you can use to write them.)
2. Implement the `lens` function, which takes a getter function `s -> a` and a setter function `s -> b -> t` and produces a `Lens s t a b`. (Hint: Your implementation will be able to minimise the repetitiveness in the solution of the previous exercise.)

47.3 Composition

The optics we have seen so far fit the shape...

```
(a -> f b) -> (s -> f t)
```

... in which:

- `f` is a `Functor` of some sort;
- `s` is the type of the whole, that is, the full structure the optic works with;
- `t` is the type of what the whole becomes through the optic;
- `a` is the type of the parts, that is, the targets within `s` that the optic focuses on; and
- `b` is the type of what the parts becomes through the optic.

One key thing those optics have in common is that *they are all functions*. More specifically, they are mapping functions that turn a function acting on a part (`a -> f b`) into a function acting on the whole (`s -> f t`). Being functions, they can be composed in the usual manner. Let's have a second look at the lens composition example from the introduction:

```
GHCi> let testSeg = makeSegment (0, 1) (2, 4)
GHCi> view (segmentEnd . positionY) testSeg
GHCi> 4.0
```

An optic modifies the function it receives as argument to make it act on a larger structure. Given that `(.)` composes functions from right to left, we find that, when reading code from left to right, the components of an optic assembled with `(.)` focus on progressively smaller parts of the original structure. The conventions used by the `lens` type synonyms match this large-to-small order, with `s` and `t` coming before `a` and `b`. The table below illustrates how we can look at what an optic does either a mapping (from small to large) or as a focusing (from large to small), using `segmentEnd . positionY` as an example:

Lens	<code>segmentEnd</code>	<code>positionY</code>	<code>segmentEnd . positionY</code>
------	-------------------------	------------------------	-------------------------------------

Bare type	Functor f => (Point -> f Point) -> (Segment - > f Segment)	Functor f => (Double -> f Double) -> (Point -> f Point)	Functor f => (Double -> f Double) -> (Segment -> f Segment)
"Mapping" interpretation	From a function on Point to a function on Segment.	From a function on Double to a function on Point.	From a function on Double to a function on Segment.
Type with Lens	Lens Segment Segment Point Point	Lens Point Point Double Double	Lens Segment Segment Double Double
Type with Lens'	Lens' Segment Point	Lens' Point Double	Lens' Segment Double
"Focusing" interpretation	Focuses on a Point within a Segment	Focuses on a Double within a Point	Focuses on a Double within a Segment

Note:

The `Lens'` synonym is just convenient shorthand for lenses that do not change types (that is, lenses with `s` equal to `t` and `a` equal to `b`).

```
type Lens' s a = Lens s s a
```

There are analogous `Traversal'` and `Setter'` synonyms as well.

The types behind synonyms such as `Lens` and `Traversal` only differ in which functors they allow in place of `f`. As a consequence, optics of different kinds can be freely mixed, as long as there is a type which all of them fit. Here are some examples:

```
GHCi> -- A Traversal on a Lens is a Traversal.
GHCi> (_2 . traverse) (\x -> [-x, x]) ("foo", [1,2])
[("foo", [-1, -2]), ("foo", [-1, 2]), ("foo", [1, -2]), ("foo", [1, 2])]
GHCi> -- A Getter on a Lens is a Getter.
GHCi> view (positionX . to negate) (makePoint (2,4))
-2.0
GHCi> -- A Getter on a Traversal is a Fold.
GHCi> toListOf (both . to negate) (2,-3)
[-2,3]
GHCi> -- A Getter on a Setter does not exist (there is no unifying optic).
GHCi> set (mapped . to length) 3 ["orange", "apple"]
```

```
<interactive>:49:15:
```

```
No instance for (Contravariant Identity) arising from a use of 'to'
In the second argument of '(.)', namely 'to length'
In the first argument of 'set', namely '(mapped . to length)'
In the expression: set (mapped . to length) 3 ["orange", "apple"]
```

47.4 Operators

Several `lens` combinators have infix operator synonyms, or at least operators nearly equivalent to them. Here are the correspondences for some of the combinators we have already seen:

Prefix	Infix
<code>view _1 (1,2)</code>	<code>(1,2) ^. _1</code>
<code>set _1 7 (1,2)</code>	<code>(_1 .~ 7) (1,2)</code>
<code>over _1 (2 *) (1,2)</code>	<code>(_1 %~ (2 *)) (1,2)</code>

Prefix	Infix
<code>toListOf traverse [1..4]</code>	<code>[1..4] ^.. traverse</code>
<code>preview traverse []</code>	<code>[] ^? traverse</code>

`lens` operators that extract values (e.g. `(^.)`, `(^..)` and `(^?)`) are flipped with respect to the corresponding prefix combinators, so that they take the structure from which the result is extracted as the first argument. That improves readability of code using them, as writing the full structure before the optics targeting parts of it mirrors how composed optics are written in large-to-small order. With the help of the `(&)` operator, which is defined simply as `flip ($)`, the structure can also be written first when using modifying operators (e.g. `(.~)` and `(%~)`). `(&)` is particularly convenient when there are many fields to modify:

```
sextupleTest = (0,1,0,1,0,1)
& _1 .~ 7
& _2 %~ (5 *)
& _3 .~ (-1)
& _4 .~ "orange"
& _5 %~ (2 +)
& _6 %~ (3 *)
```

```
GHCi> sextupleTest
(7,5,-1,"orange",2,3)
```

47.5 A swiss army knife

Thus far we have covered enough of `lens` to introduce lenses and show that they aren't arcane magic. That, however, is only the tip of the iceberg. `lens` is a large library providing a rich assortment of tools, which in turn realise a colourful palette of concepts. The odds are that if you think of anything in the core libraries there will be a combinator somewhere in `lens` that works with it. It is no exaggeration to say that a book exploring every corner of `lens` might be made as long as this one you are reading. Unfortunately, we cannot undertake such an endeavour right here. What we can do is briefly discussing a few other general-purpose `lens` tools you are bound to encounter in the wild at some point.

47.5.1 State manipulation

There are quite a few combinators for working with state functors peppered over the `lens` modules. For instance:

- `use` from `Control.Lens.Getter` is an analogue of `gets` from `Control.Monad.State` that takes a getter instead of a plain function.
- `Control.Lens.Setter` includes suggestive-looking operators that modify parts of a state targeted a setter (e.g. `.=` is analogous to `set`, `%=` to `over` and `(+= x)` to `over (+x)`).
- `Control.Lens.Zoom`¹² offers the remarkably handy `zoom` combinator, which uses a traversal (or a lens) to zoom into a part of a state. It does so by lifting a stateful computation into one that works with a larger state, of which the original state is a part.

¹² <http://hackage.haskell.org/packages/archive/lens/latest/doc/html/Control-Lens-Zoom.html>

Such combinators can be used to write highly intention-revealing code that transparently manipulates deep parts of a state:

```
import Control.Monad.State

stateExample :: State Segment ()
stateExample = do
  segmentStart .= makePoint (0,0)
  zoom segmentEnd $ do
    positionX += 1
    positionY *= 2
    pointCoordinates %= negate

GHCi> execState stateExample (makeSegment (1,2) (5,3))
Segment {_segmentStart = Point {_positionX = 0.0, _positionY = 0.0}
, _segmentEnd = Point {_positionX = -6.0, _positionY = -6.0}}
```

47.5.2 Isos

In our series of `Point` and `Segment` examples, we have been using the `makePoint` function as a convenient way to make a `Point` out of `(Double, Double)` pair.

```
makePoint :: (Double, Double) -> Point
makePoint (x, y) = Point x y
```

The X and Y coordinates of the resulting `Point` correspond exactly to the two components of the original pair. That being so, we can define an `unmakePoint` function...

```
unmakePoint :: Point -> (Double, Double)
unmakePoint (Point x y) = (x,y)
```

... so that `makePoint` and `unmakePoint` are a pair of *inverses*, that is, they undo each other:

```
unmakePoint . makePoint = id
makePoint . unmakePoint = id
```

In other words, `makePoint` and `unmakePoint` provide a way to losslessly convert a pair to a point and vice-versa. Using jargon, we can say that `makePoint` and `unmakePoint` form an *isomorphism*.

`unmakePoint` might be made into a `Lens' Point (Double, Double)`. Symmetrically, `makePoint` would give rise to a `Lens' (Double, Double) Point`, and the two lenses would be a pair of inverses. Lenses with inverses have a type synonym of their own, `Iso`, as well as some extra tools defined in `Control.Lens.Iso`¹³.

An `Iso` can be built from a pair of inverses through the `iso` function:

```
iso :: (s -> a) -> (b -> t) -> Iso s t a b

pointPair :: Iso' Point (Double, Double)
pointPair = iso unmakePoint makePoint
```

Isos are `Lenses`, and so the familiar lens combinators work as usual:

¹³ <http://hackage.haskell.org/packages/archive/lens/latest/doc/html/Control-Lens-Iso.html>

```
GHCi> import Data.Tuple (swap)
GHCi> let testPoint = makePoint (2,3)
GHCi> view pointPair testPoint -- Equivalent to unmakePoint
(2.0,3.0)
GHCi> view (pointPair . _2) testPoint
3.0
GHCi> over pointPair swap testPoint
Point {_positionX = 3.0, _positionY = 2.0}
```

Additionally, `Isos` can be inverted using `from`:

```
GHCi> :info from pointPair
from :: AnIso s t a b -> Iso b a t s
      -- Defined in 'Control.Lens.Iso'
pointPair :: Iso' Point (Double, Double)
          -- Defined at WikibookLenses.hs:77:1
GHCi> view (from pointPair) (2,3) -- Equivalent to makePoint
Point {_positionX = 2.0, _positionY = 3.0}
GHCi> view (from pointPair . positionY) (2,3)
3.0
```

Another interesting combinator is `under`. As the name suggests, it is just like `over`, except that it uses the inverted `Iso` that `from` would give us. We will demonstrate it by using the `enum` isomorphism to play with the `Int` representation of `Chars` without using `chr` and `ord` from `Data.Char` explicitly:

```
GHCi> :info enum
enum :: Enum a => Iso' Int a
      -- Defined in 'Control.Lens.Iso'
GHCi> under enum (+7) 'a'
'h'
```

`newtypes` and other single-constructor types give rise to isomorphisms. `Control.Lens.Wrapped`¹⁴ exploits that fact to provide `Iso`-based tools which, for instance, make it unnecessary to remember record label names for unwrapping `newtypes`...

```
GHCi> let testConst = Const "foo"
GHCi> -- getConst testConst
GHCi> op Const testConst
"foo"
GHCi> let testIdent = Identity "bar"
GHCi> -- runIdentity testIdent
GHCi> op Identity testIdent
"bar"
```

... and that make `newtype` wrapping for instance selection less messy:

```
GHCi> :m +Data.Monoid
GHCi> -- getSum (foldMap Sum [1..10])
GHCi> ala Sum foldMap [1..10]
55
GHCi> -- getProduct (foldMap Product [1..10])
GHCi> ala Product foldMap [1..10]
3628800
```

¹⁴ <http://hackage.haskell.org/packages/archive/lens/latest/doc/html/Control-Lens-Wrapped.html>

47.5.3 Prisms

With `Iso`, we have reached for the first time a rank below `Lens` in the hierarchy of optics: every `Iso` is a `Lens`, but not every `Lens` is an `Iso`. By going back to `Traversal`, we can observe how the optics get progressively less precise in what they point to:

- An `Iso` is an optic that has exactly one target and is invertible.
- A `Lens` also has exactly one target but is not invertible.
- A `Traversable` can have any number of targets and is not invertible.

Along the way, we first dropped invertibility and then the uniqueness of targets. If we follow a different path by dropping uniqueness before invertibility, we find a second kind of optic between isomorphisms and traversals: *prisms*. A `Prism` is an invertible optic that need not have exactly one target. As invertibility is incompatible with multiple targets, we can be more precise: a `Prism` can reach either no targets or exactly one target.

Aiming at a single target with the possibility of failure sounds a lot like pattern matching, and prisms are indeed able to capture that. If tuples and records provide natural examples of lenses, `Maybe`, `Either` and other types with multiple constructors play the same role for prisms.

Every `Prism` is a `Traversal`, and so the usual combinators for traversals, setters and folds all work with prisms:

```
GHCi> set _Just 5 (Just "orange")
Just 5
GHCi> set _Just 5 Nothing
Nothing
GHCi> over _Right (2 *) (Right 5)
Right 10
GHCi> over _Right (2 *) (Left 5)
Left 5
GHCi> toListOf _Left (Left 5)
[5]
```

A `Prism` is not a `Getter`, though: the target might not be there. For that reason, we use `preview` rather than `view` to retrieve the target:

```
GHCi> preview _Right (Right 5)
Just 5
GHCi> preview _Right (Left 5)
Nothing
```

For inverting a `Prism`, we use `re` and `review` from `Control.Lens.Review`¹⁵. `re` is analogous to `from`, though it gives merely a `Getter`. `review` is equivalent to `view` with the inverted prism.

```
GHCi> view (re _Right) 3
Right 3
GHCi> review _Right 3
Right 3
```

¹⁵ <http://hackage.haskell.org/packages/archive/lens/latest/doc/html/Control-Lens-Review.html>

Just like there is more to lenses than reaching record fields, prisms are not limited to matching constructors. For instance, `Control.Lens.Prism`¹⁶ defines `only`, which encodes equality tests as a `Prism`:

```
GHCi> :info only
only :: Eq a => a -> Prism' a ()
      -- Defined in 'Control.Lens.Prism'
GHCi> preview (only 4) (2 + 2)
Just ()
GHCi> preview (only 5) (2 + 2)
Nothing
```

The `prism` and `prism'` functions allow us to build our own prisms. Here is an example using `stripPrefix` from `Data.List`:

```
GHCi> :info prism
prism :: (b -> t) -> (s -> Either t a) -> Prism s t a b
      -- Defined in 'Control.Lens.Prism'
GHCi> :info prism'
prism' :: (b -> s) -> (s -> Maybe a) -> Prism s s a b
      -- Defined in 'Control.Lens.Prism'
GHCi> import Data.List (stripPrefix)
GHCi> :t stripPrefix
stripPrefix :: Eq a => [a] -> [a] -> Maybe [a]

prefixed :: Eq a => [a] -> Prism' [a] [a]
prefixed prefix = prism' (prefix ++) (stripPrefix prefix)
```

```
GHCi> preview (prefixed "tele") "telescope"
Just "scope"
GHCi> preview (prefixed "tele") "orange"
Nothing
GHCi> review (prefixed "tele") "graph"
"telegraph"
```

`prefixed` is available from `lens`, in the `Data.List.Lens`¹⁷ module.

Exercises:

1. `Control.Lens.Prism` defines an `outside` function, which has the following (simplified) type:

```
outside :: Prism s t a b
         -> Lens (t -> r) (s -> r) (b -> r) (a -> r)
```

 - a) Explain what `outside` does without mentioning its implementation. (Hint: The documentation says that with it we can "use a `Prism` as a kind of first-class pattern". Your answer should expand on that, explaining how we can use it in such a way.)
 - b) Use `outside` to implement `maybe` and `either` from the Prelude:

```
maybe :: b -> (a -> b) -> Maybe a -> b
either  :: (a -> c) -> (b -> c) -> Either a b -> c
```

16 <http://hackage.haskell.org/packages/archive/lens/latest/doc/html/Control-Lens-Prism.html>

17 <http://hackage.haskell.org/packages/archive/lens/latest/doc/html/Data-List-Lens.html>

47.6 Laws

There are laws specifying how sensible optics should behave. We will now survey those that apply to the optics that we covered here.

Starting from the top of the taxonomy, `Fold` does not have laws, just like the `Foldable` class. `Getter` does not have laws either, which is not surprising, given that any function can be made into a `Getter` via `to`.

`Setter`, however, does have laws. `over` is a generalisation of `fmap`, and is therefore subject to the functor laws:

```
over s id = id
over s g . over s f = over s (g . f)
```

As `set s x = over s (const x)`, a consequence of the second functor law is that:

```
set s y . set s x = set s y
```

That is, setting twice is the same as setting once.

`Traversal` laws, similarly, are generalisations of the `Traversable` laws:

```
t pure = pure
fmap (t g) . t f = getCompose . t (Compose . fmap g . f)
```

The consequences discussed in the `Traversable`¹⁸ chapter follow as well: a traversal visits all of its targets exactly once, and must either preserve the surrounding structure or destroy it wholly.

Every `Lens` is a `Traversal` and a `Setter`, and so the laws above also hold for lenses. In addition, every `Lens` is also a `Getter`. Given that a lens is both a getter and a setter, it should get the same target that it sets. This common sense requirement is expressed by the following laws:

```
view l (set l x) = x
set l (view l z) z = z
```

Together with the "setting twice" law of setters presented above, those laws are commonly referred to as the *lens laws*.

Analogous laws hold for `Prisms`, with `preview` instead of `view` and `review` instead of `set`:

```
preview p (review p x) = Just x
review p <$> preview p z = Just z -- If preview p z isn't Nothing.
```

`Isos` are both lenses and prisms, so all of the laws above hold for them. The prism laws, however, can be simplified, given that for isomorphisms `preview i = Just . view i` (that is, `preview` never fails):

```
view i (review i x) = x
review i (view i z) = z
```

18 Chapter 42.3 on page 286

47.6.1 Polymorphic updates

When we look at optic types such as `Setter s t a b` and `Lens s t a b` we see four independent type variables. However, if we take the various optic laws into account we find out that not all choices of `s`, `t`, `a` and `b` are reasonable. For instance, consider the "setting twice" law of setters:

```
set s y . set s x = set s y
```

For "setting twice is the same than setting once" to make sense, it must be possible to set twice using the same setter. As a consequence, the law can only hold for a `Setter s t a b` if `t` can somehow be specialised so that it becomes equal to `s` (otherwise the type of the whole would change on every `set`, leading to a type mismatch).

From considerations about the types involved in the laws such as the one above, it follows that the four type parameters in law-abiding `Setters`, `Traversals`, `Prisms` and `Lenses` are not fully independent from each other. We won't examine the interdependency in detail, but merely point out some of its consequences. Firstly, `a` and `b` are cut from the same cloth, in that even if an optic can change types there must be a way of specialising `a` and `b` to make them equal; furthermore, the same holds for `s` and `t`. Secondly, if `a` and `b` are equal then `s` and `t` must be equal as well.

In practice, those restrictions mean that valid optics that can change types usually have `s` and `t` parametrised in terms of `a` and `b`. Type-changing updates in this fashion are often referred to as *polymorphic updates*. For the sake of illustration, here are a few arbitrary examples taken from `lens`:

```
-- To avoid distracting details,
-- we specialised the types of argument and _1.
mapped :: Functor f => Setter (f a) (f b) a b
contramapped :: Contravariant f => Setter (f b) (f a) a b
argument :: Setter (b -> r) (a -> r) a b
traverse :: Traversable t => Traversal (t a) (t b) a b
both :: Bitraversable r => Traversal (r a a) (r b b) a b
_1 :: Lens (a, c) (b, c) a b
_Just :: Prism (Maybe a) (Maybe b) a b
```

At this point, we can return to the question left open when we presented the `Lens` type. Given that `Lens` and `Traversal` allow type changing while `Getter` and `Fold` do not, it would be indeed rash to say that every `Lens` is a `Getter`, or that every `Traversal` is a `Fold`. However, the interdependence of the type variables mean that every *lawful* `Lens` can be used as a `Getter`, and every lawful `Traversal` can be used as a `Fold`, as lawful lenses and traversals can always be used in non type-changing ways.

47.7 No strings attached

As we have seen, we can use `lens` to define optics through functions such as `lens` and auto-generation tools such as `makeLenses`. Strictly speaking, though, these are merely convenience helpers. Given that `Lens`, `Traversal` and so forth are just type synonyms, their definitions are not needed when writing optics – for instance, we can always write `Functor f => (a -> f b) -> (s -> f t)` instead of `Lens s t a b`. That means we can

define optics compatible with `lens` without using `lens` at all! In fact, any `Lens`, `Traversal`, `Setter` or `Getting` can be defined with no dependencies other than the `base` package.

The ability to define optics without depending on the `lens` library provides considerable flexibility in how they can be leveraged. While there are libraries that do depend on `lens`, library authors are often wary of acquiring a dependency on large packages with several dependencies such as `lens`, especially when writing small, general-purpose libraries. Such concerns can be sidestepped by defining the optics without using the type synonyms or the helper tools in `lens`. Furthermore, the types being only synonyms makes it possible to have multiple optic frameworks (i.e. `lens` and similar libraries) that can be used interchangeably.

47.8 Further reading

- Several paragraphs above, we said that `lens` easily provides enough material for a full book. The closest thing to that we currently have is Artyom Kazak's "lens over tea"¹⁹ series of blog posts. It explores the implementation of functional references in `lens` and the concepts behind it in far more depth than what we are able to do here. Highly recommended reading.
- Useful information can be reached through `lens`' GitHub wiki²⁰, and of course `lens`' API documentation²¹ is well worth exploring.
- `lens` is a large and complex library. If you want to study its implementation but would rather begin with something simpler, a good place to start are minimalistic `lens`-compatible libraries such as `microlens`²² and `lens-simple`²³.
- Studying (and using!) optic-powered libraries is a good way to get the hang of how functional references are used. Some arbitrary examples:
 - `diagrams`²⁴, a vector graphics library that uses `lens` extensively to deal with properties of graphic elements.
 - `wreq`²⁵, a web client library with a `lens`-based interface.
 - `xml-lens`²⁶, which provides optics for manipulating XML.
 - `formattable`²⁷, a library for date, time and number formatting. `Formattable.NumFormat`²⁸ is an example of a module that provides `lens`-compatible lenses without depending on the `lens` package.

19 <http://artyom.me/lens-over-tea-1>

20 <https://github.com/ekmett/lens/wiki>

21 <https://hackage.haskell.org/package/lens>

22 <http://hackage.haskell.org/package/microlens>

23 <http://hackage.haskell.org/package/lens-simple>

24 <http://projects.haskell.org/diagrams/>

25 <http://www.serpentine.com/wreq/>

26 <https://hackage.haskell.org/package/xml-lens>

27 <http://hackage.haskell.org/package/formattable>

28 <http://hackage.haskell.org/packages/archive/formattable/latest/doc/html/Formattable-NumFormat.html>

48 Mutable objects

Functional purity is a defining characteristic of Haskell, one which leads to many of its strengths. As such, language and ecosystem encourage eschewing mutable state altogether. Thanks to tools such as the `State` monad¹, which allows us to keep track of state in a convenient and functionally pure way, and efficient immutable data structures² like the ones provided by the `containers` and `unordered-containers` packages, Haskell programmers can get by perfectly fine with complete immutability in the vast majority of situations. However, under select circumstances using mutable state is just the most sensible option. One might, for instance, be interested in:

- From Haskell code, using a library written in another language which assumes mutable state everywhere. This situation often arises with event-callback GUI toolkits.
- Using Haskell to implement a language that provides imperative-style mutable variables.
- Implementing algorithms that inherently require destructive updates to variables.
- Dealing with volumes of bulk data massive enough to justify squeezing every drop of computational power available to make the problem at hand feasible.

Any general-purpose programming language worth its salt should be able to deal with such tasks. With Haskell, it is no different: there are not only ways to create mutable objects, but also to keep mutability under control, existing peacefully in a setting where immutability is the default.

48.1 IORefs

Let's begin with the simplest of those use cases above. A common way of structuring code for user interfaces is through the event-and-callback model. The event might be a button click or a key press, while the callback is just a piece of code meant to be called in response to the event. The client code (that is, your code, if you are using such a library) should set up the wiring that connects interface elements, events involving them, and the corresponding callbacks. A hypothetical function to arrange a callback might have the following type:

```
register :: (Element -> Event) -> Element -> IO () -> IO ()
```

The `IO ()` argument is the callback, while the result of `register` is an `IO` action which sets up the wiring. Running `register click button1 (print "Hello")` would lead to "Hello" being printed on the console following every click on `button1`.

¹ Chapter 35 on page 219

² <https://en.wikibooks.org/wiki/Haskell%2FLibraries%2FData%20structures%20primer>

Both `register` — with pervasive IO and lacking useful return values — and our exposition above have a marked imperative feel. That's because our hypothetical GUI library was written using a more imperative style in a wholly different language. Some good soul has written a facade so that we can use it from Haskell, but the facade is a very thin one, and so the style of the original library leaks into our code ³.

Using `register` to perform IO actions such as printing to the console or showing dialog boxes is easy enough. However, what if we want to add 1 to a counter every time a button is clicked? The type of `register` doesn't reveal any way to pass information to the callback, nor to get information back from it (the return types are `()`). `State` doesn't help: even if there was a way to pass an initial state to the callback, run a `State` computation within it, what would we do with the results? We would need to pass the resulting state of the counter to the callback on the next time the button is clicked, and we would have no idea when that would happen, nor a place to keep the value in the meantime.

The obvious solution to this issue in many languages would be creating a *mutable* variable outside of the callback and then giving the callback a *reference* to it, so that its code can change the value of the variable at will. We need not worry, though, as Haskell allows us to do exactly that. In fact, there are several types of mutable variables available, the simplest of which is the `IORef`. `IORefs` are very simple; they are just boxes containing mutable values. We can create one as follows:

```
GHCi> import Data.IORef
GHCi> :t newIORef
newIORef :: a -> IO (IORef a)
GHCi> box <- newIORef (4 :: Int)
```

`newIORef` takes a value and gives back, as the result of an IO action, an `IORef` initialised to that value. We can then use `readIORef` to retrieve the value in it...

```
GHCi> :t readIORef
readIORef :: IORef a -> IO a
GHCi> readIORef box >>= print
4
```

... and `modifyIORef` and `writeIORef` to change it:

```
GHCi> modifyIORef box (2*)
GHCi> readIORef box >>= print
8
GHCi> writeIORef box 0
GHCi> readIORef box >>= print
0
```

An `IORef` would be enough for implementing the counter, given that it would persist between button clicks. The code might look like this:

```
setupGUI :: IORef Int -> IO ()
setupGUI counter = do
```

³ The technical term for facades over libraries from other languages is *bindings*. Bindings can be thin, exposing transparently the constructs of the original library, or they can add extra layers of abstraction can be built on to achieve a more Haskell-like feel. The elementary tool for creating bindings in Haskell is the *foreign function interface*, which we cover in a chapter of Haskell in Practice ^{Chapter82 on page 579}.

```

-- However much other GUI preparation code we need.
register click button1 (modifyIORef counter (+1))

main :: IO ()
main = do
  -- etc.
  counter <- newIORef (0 :: Int)
  setupGUI counter
  -- Then just use the counter value wherever necessary.

```

Note there is no point in using IORefs indiscriminately, without a good reason for it. Beyond the more fundamental concerns with mutable state, it just would not be very convenient to do so with all those explicit read/write/modify calls, not to mention the need to introduce IO in extra places to handle the IORef (in our hypothetical example that wouldn't be much of an issue, as the GUI code would have to live in IO anyway, and we presumably would keep it apart from the pure functions forming the core of our program, as good Haskell practice dictates). Still, IORefs are there for when you can't avoid them.

48.1.1 The pitfalls of concurrency

There is another very important use case for mutable variables that we didn't mention in the introduction: *concurrency*, that is, circumstances when simultaneous computations are being executed by the computer. Concurrency scenarios range from the trivial (a progress bar displaying the status of a background task) to the extremely complex (server-side software handling thousands of requests at once). Given that in principle nothing guarantees that simultaneous computations will run in step with each other, any communication between them calls for mutable variables. That, however, introduces a complication: the issues with understandability and predictability of code using mutable state become much more serious in the presence of independent computations with unpredictable timings. For instance, computation A might need the result of computation B, but it might ask for that result earlier than predicted and thus acquire a bogus result. Writing correct concurrent code can be difficult, and subtle bugs are easy to introduce unless adequate measures are taken.

The only functions in `Data.IORef`⁴ that provide extra safety in concurrent code are `atomicModifyIORef`, `atomicModifyIORef'` and `atomicWriteIORef`, which are only of any help in very simple situations in which there is just one IORef meant to be used as a shared resource between computations. Concurrent Haskell code should take advantage of more sophisticated tools tailored for concurrency, such as MVars (mutable variables that a computation can make unavailable to the others for as long as necessary — see `Control.Concurrent.MVar`⁵) and `Control.Concurrent.STM`⁶ from the `stm` package (an implementation of *software transactional memory*, a concurrency model which makes it possible to write safe concurrent code while avoiding the ugliness and complications of having to explicitly manage the availability of all shared variables)⁷.

4 <http://hackage.haskell.org/packages/archive/base/latest/doc/html/Data-IORef.html>

5 <http://hackage.haskell.org/packages/archive/base/latest/doc/html/Control-Concurrent-MVar.html>

6 <http://hackage.haskell.org/packages/archive/stm/latest/doc/html/Control-Concurrent-STM.html>

7 [Control-Concurrent-STM.html](http://hackage.haskell.org/packages/archive/stm/latest/doc/html/Control-Concurrent-STM.html)

A future chapter of this book will introduce some of those features.

48.2 The ST monad

In the `IORef` example above, mutability was imposed upon our code by external demands. However, in the two final scenarios suggested by the introduction (algorithms that require mutability and extreme computational demands) the need for mutable state is internal — that is, it is not reflected in any way in the overall results. For instance, sorting a list does not require mutability in any essential way, and so a function that sorts a list and returns a new list should, in principle, be functionally pure even if the sorting algorithm uses destructive updates to swap the position of the elements. In such case, the mutability is just an implementation detail. The standard libraries provide a nifty tool for handling such situations while still ending up with pure functions: the ST monad, which can be found in `Control.Monad.ST`⁸.

```
data ST s a
```

`ST s a` looks a lot like `State s a`, and indeed they are similar in spirit. An ST computation is one that uses an internal state to produce results, except that the state is mutable. For that purpose, `Data.STRef`⁹ provides `STRefs`. A `STRef s a` is exactly like an `IORef a`, but it lives in the `ST s` monad rather than in `IO`.

There is one *major* difference that sets apart `ST` from both `State` and `IO`. `Control.Monad.ST` offers a `runST` function with the following type:

```
runST :: (forall s. ST s a) -> a
```

At first, that is a shocking type signature. If `ST` involves mutability, how come we can simply extract a values from the monad? The answer lies in the `forall s.` part of the type. Having a `forall s.` enclosed within the type of an argument amounts to telling the type checker "s could be anything. Don't make any assumptions about it". Not making any assumptions, however, means that `s` cannot be matched with anything else — even with the `s` from another invocation of `runST`¹⁰:

```
GHCi> import Control.Monad.ST
GHCi> import Data.STRef
GHCi> -- Attempt to keep an STRef around to pass to pure code:
GHCi> let ref = runST $ newSTRef (4 :: Int)

<interactive>:125:19:
  Couldn't match type 'a' with 'STRef s Int'
    because type variable 's' would escape its scope
  This (rigid, skolem) type variable is bound by
    a type expected by the context: ST s a
    at <interactive>:125:11-37
  Expected type: ST s a
  Actual type: ST s (STRef s Int)
  Relevant bindings include ref :: a (bound at <interactive>:125:5)
  In the second argument of '($)', namely 'newSTRef (4 :: Int)'
  In the expression: runST $ newSTRef (4 :: Int)
GHCi> -- The error message is quite clear:
GHCi> -- "because type variable 's' would escape its scope"
```

8 <http://hackage.haskell.org/packages/archive/base/latest/doc/html/Control-Monad-ST.html>

9 <http://hackage.haskell.org/packages/archive/base/latest/doc/html/Data-STRef.html>

10 This is an example of an *existential type*. "Existential" is meant in a precise technical sense, but we can get the gist of it by noting that the only thing we know about it is that it exists.

```
GHCi> -- Attempt to feed an STRef from one ST computation to another:
GHCi> let x = runST $ readSTRef =<< runST (newSTRef (4 :: Int))

<interactive>:129:38:
  Couldn't match type 'STRef s1 Int' with 'ST s (STRef s a)'
  Expected type: ST s1 (ST s (STRef s a))
  Actual type: ST s1 (STRef s1 Int)
  Relevant bindings include x :: a (bound at <interactive>:129:5)
  In the first argument of 'runST', namely '(newSTRef (4 :: Int))'
  In the second argument of '(=<<)', namely
    'runST (newSTRef (4 :: Int))'
GHCi> -- The 's' from each computation are necessarily not the same.
```

The overall effect of this type trickery is to insulate the internal state and mutability within each ST computation, so that from the point of view of anything else in the program `runST` is a pure function.

As a trivial example of ST in action, here is a very imperative-looking version of `sum` for lists ¹¹:

```
import Control.Monad.ST
import Data.STRef
import Data.Foldable

sumST :: Num a => [a] -> a
sumST xs = runST $ do
  n <- newSTRef 0
  for_ xs $ \x ->
    modifySTRef n (+x)
  readSTRef n
```

For all intents and purposes, `sumST` is no less pure than the familiar `sum`. The fact that it destructively updates its accumulator `n` is a mere implementation detail, and there is no way information about `n` could leak other than through the final result. Looking at a simple example like this one makes it clear that the `s` type variable in `ST s a` does not correspond to anything in particular within the computation — it is just an artificial marker. Another detail worth noting is that even though `for_` folds the list from the right the sums are done from the left, as the mutations are performed as applicative effects sequenced from left to right.

48.3 Mutable data structures

Mutable data structures can be found in the libraries for the exceptional use cases for which they prove necessary. For instance, mutable arrays (alongside with immutable ones) can be found in the `vector`¹² package or the `array`¹³ package bundled with GHC ¹⁴. There are also mutable hash tables, such as those from the `hashtables` package¹⁵. In all cases mentioned, both ST and IO versions are provided.

¹¹ Adapted from the HaskellWiki page on ST ^{<https://wiki.haskell.org/Monad/ST>}.

¹² <https://hackage.haskell.org/package/vector>

¹³ <https://hackage.haskell.org/package/array>

¹⁴ For general observations on arrays, see the data structures primer ^{<https://en.wikibooks.org/wiki/Haskell%2FLibraries%2FData%20structures%20primer%23Raw%20performance%20with%20arrays>}.

¹⁵ <https://hackage.haskell.org/package/hashtables>

48.4 Further reading

- The seventh chapter of *Write Yourself a Scheme in 48 Hours*¹⁶ provides an interesting example of `IORefs` being used to implement mutable variables in a language.
- Lennart Augustsson's blog¹⁷ shows how a true quicksort (that is, one using the original algorithm which performs destructive updates to sort the list) can be implemented in Haskell, just like we assured that was possible way back in *Haskell/Higher-order functions*¹⁸. His implementation is quite amusing thanks to the combinators used to handle mutability, which make Haskell look like C. Be sure to check the two posts before the one linked to see how that was done.

¹⁶ https://en.wikibooks.org/wiki/Write_Yourself_a_Scheme_in_48_Hours%2FAdding_Variables_and_Assignment

¹⁷ <http://augustss.blogspot.com.br/2007/08/quicksort-in-haskell-quicksort-is.html>

¹⁸ Chapter 19 on page 127

49 Concurrency

49.1 Concurrency

Concurrency in Haskell is mostly done with Haskell threads. Haskell threads are user-space threads that are implemented in the runtime. Haskell threads are much more efficient in terms of both time and space than Operating System threads. Apart from traditional synchronization primitives like semaphores, Haskell offers Software Transactional Memory which greatly simplifies concurrent access to shared memory.

The modules for concurrency are `Control.Concurrent.*` and `Control.Monad.STM`.

49.2 When do you need it?

Perhaps more important than **when** is **when not**. Concurrency in Haskell is not used to utilize multiple processor cores; you need another thing, "parallelism"¹, for that. Instead, concurrency is used for when a single core must divide its attention between various things, typically IO.

For example, consider a simple "static" webserver (i.e. serves only static content such as images). Ideally, such a webserver should consume few processing resources; instead, it must be able to transfer data as fast as possible. The bottleneck should be I/O, where you can throw more hardware at the problem. So you must be able to efficiently utilize a single processor core among several connections.

In a C version of such a webserver, you'd use a big loop centered around `select()` on each connection and on the listening socket. Each open connection would have an attached data structure specifying the state of that connection (i.e. receiving the HTTP header, parsing it, sending the file). Such a big loop would be difficult and error-prone to code by hand. However, using Concurrent Haskell, you would be able to write a much smaller loop concentrating solely on the listening socket, which would spawn a new "thread" for each accepted connection. You can then write a new "thread" in the IO monad which, in sequence, receives the HTTP header, parses it, and sends the file.

Internally, the Haskell compiler will then convert the spawning of the thread to an allocation of a small structure specifying the state of the "thread", congruent to the data structure you would have defined in C. It will then convert the various threads into a single big loop. Thus, while you write as if each thread is independent, internally the compiler will convert it to a big loop centered around `select()` or whatever alternative is best on your system.

¹ <https://en.wikibooks.org/wiki/Haskell%2FParallelism>

49.3 Example

Example: Downloading files in parallel

```
downloadFile :: URL -> IO ()
downloadFile = undefined

downloadFiles :: [URL] -> IO ()
downloadFiles = mapM_ (forkIO . downloadFile)
```

49.4 Software Transactional Memory

Software Transactional Memory (STM) is a mechanism that allows transactions on memory similar to database transactions. It greatly simplifies access to shared resources when programming in a multithreaded environment. By using STM, you no longer have to rely on locking.

To use STM, you have to include `Control.Monad.STM`. To change into the STM-Monad the `atomically` function is used. STM offers different primitives (`TVar`, `TMVar`, `TChan` and `TArray`) that can be used for communication.

The following example shows how to use a `TChan` to communicate between two threads. The channel is created in the main function and handed over to the `readerThread`/`writerThread` functions. The `readerThread` waits on the `TChan` for new input and prints it. The `writerThread` writes some `Int`-values to the channel and terminates.

Example: Communication with a TChan

```
import Control.Monad.STM
import Control.Concurrent
import Control.Concurrent.STM.TChan

oneSecond = 1000000

writerThread :: TChan Int -> IO ()
writerThread chan = do
  atomically $ writeTChan chan 1
  threadDelay oneSecond
  atomically $ writeTChan chan 2
  threadDelay oneSecond
  atomically $ writeTChan chan 3
  threadDelay oneSecond

readerThread :: TChan Int -> IO ()
readerThread chan = do
  newInt <- atomically $ readTChan chan
  putStrLn $ "read new value: " ++ show newInt
  readerThread chan

main = do
  chan <- atomically $ newTChan
  forkIO $ readerThread chan
  forkIO $ writerThread chan
  threadDelay $ 5 * oneSecond
```

50 Fun with Types

51 Polymorphism basics

51.1 Parametric Polymorphism

Section goal = short, enables reader to read code (ParseP) with \forall and use libraries (ST) without horror. Question [Talk:Haskell/The_Curry-Howard_isomorphism#Polymorphic types](#)¹ would be solved by this section.

Link to the following paper: Luca Cardelli: [On Understanding Types, Data Abstraction, and Polymorphism](#)².

51.1.1 forall a

As you may know, a **polymorphic** function is a function that works for many different types. For instance,

```
length :: [a] -> Int
```

can calculate the length of any list, be it a string `String = [Char]` or a list of integers `[Int]`. The **type variable** `a` indicates that `length` accepts any element type. Other examples of polymorphic functions are

```
fst :: (a, b) -> a
snd :: (a, b) -> b
map :: (a -> b) -> [a] -> [b]
```

Type variables always **begin in lowercase** whereas concrete types like `Int` or `String` always start with an uppercase letter, that's how we can tell them apart.

There is a more **explicit** way to indicate that `a` can be any type

```
length :: forall a. [a] -> Int
```

In other words, "for all types `a`, the function `length` takes a list of elements of type `a` and returns an integer". You should think of the old signature as an abbreviation for the new one with the `forall`³. That is, the compiler will internally insert any missing `forall` for you. Another example: the types signature for `fst` is really a shorthand for

```
fst :: forall a. forall b. (a,b) -> a
```

1 https://en.wikibooks.org/wiki/Talk%3AHaskell%2FThe_Curry-Howard_isomorphism%23Polymorphic%20types

2 <http://lucacardelli.name/Papers/OnUnderstanding.A4.pdf>

3 Note that the keyword `forall` is not part of the Haskell 98 standard, but any of the language extensions `ScopedTypeVariables`, `Rank2Types` or `RankNTypes` will enable it in the compiler. A future Haskell standard will incorporate one of these.

or equivalently

```
fst :: forall a b. (a,b) -> a
```

Similarly, the type of `map` is really

```
map :: forall a b. (a -> b) -> [a] -> [b]
```

The idea that something is applicable to every type or holds for everything is called **universal quantification**⁴. In mathematical logic, the symbol \forall ⁵ (an upside-down A, read as "forall") is commonly used for that, it is called the **universal quantifier**.

51.1.2 Higher rank types

With explicit `forall`, it now becomes possible to write functions that expect **polymorphic arguments**, like for instance

```
foo :: (forall a. a -> a) -> (Char, Bool)
foo f = (f 'c', f True)
```

Here, `f` is a polymorphic function, it can be applied to anything. In particular, `foo` can apply it to both the character `'c'` and the boolean `True`.

It is not possible to write a function like `foo` in Haskell98, the type checker will complain that `f` may only be applied to values of either the type `Char` or the type `Bool` and reject the definition. The closest we could come to the type signature of `foo` would be

```
bar :: (a -> a) -> (Char, Bool)
```

which is the same as

```
bar :: forall a. ((a -> a) -> (Char, Bool))
```

But this is very different from `foo`. The `forall` at the outermost level means that `bar` promises to work with any argument `f` as long as `f` has the shape `a -> a` for some type `a` unknown to `bar`. Contrast this with `foo`, where it's the argument `f` who promises to be of shape `a -> a` for all types `a` at the same time, and it's `foo` who makes use of that promise by choosing both `a = Char` and `a = Bool`.

Concerning nomenclature, simple polymorphic functions like `bar` are said to have a rank-1 type while the type `foo` is classified as **rank-2 type**. In general, a **rank-n type** is a function that has at least one rank-(n-1) argument but no arguments of even higher rank.

The theoretical basis for higher rank types is **System F**⁶, also known as the second-order lambda calculus. We will detail it in the section **System F**⁷ in order to better understand the meaning of `forall` and its placement like in `foo` and `bar`.

4 <https://en.wikipedia.org/wiki/Universal%20quantification>

5 The `UnicodeSyntax` extension allows you to use the symbol \forall instead of the `forall` keyword in your Haskell source code.

6 <https://en.wikipedia.org/wiki/System%20F>

7 Chapter 51.2 on page 384

Haskell98 is based on the Hindley-Milner⁸ type system, which is a restriction of System F and does not support `forall` and rank-2 types or types of even higher rank. You have to enable the `RankNTypes`⁹ language extension to make use of the full power of System F.

But of course, there is a good reason that Haskell98 does not support higher rank types: type inference for the full System F is undecidable, the programmer would have to write down all type signatures. Thus, the early versions of Haskell have adopted the Hindley-Milner type system which only offers simple polymorphic function but enables complete type inference in return. Recent advances in research have reduced the burden of writing type signatures and made rank-n types practical in current Haskell compilers.

51.1.3 runST

For the practical Haskell programmer, the ST monad¹⁰ is probably the first example of a rank-2 type in the wild. Similar to the IO monad, it offers mutable references

```
newSTRef  :: a -> ST s (STRef s a)
readSTRef :: STRef s a -> ST s a
writeSTRef :: STRef s a -> a -> ST s ()
```

and mutable arrays. The type variable `s` represents the state that is being manipulated. But unlike IO, these stateful computations can be used in pure code. In particular, the function

```
runST :: (forall s. ST s a) -> a
```

sets up the initial state, runs the computation, discards the state and returns the result. As you can see, it has a rank-2 type. Why?

The point is that mutable references should be local to one `runST`. For instance,

```
v = runST (newSTRef "abc")
foo = runST (readSTRef v)
```

is wrong because a mutable reference created in the context of one `runST` is used again in a second `runST`. In other words, the result type `a` in `(forall s. ST s a) -> a` may not be a reference like `STRef s String` in the case of `v`. But the rank-2 type guarantees exactly that! Because the argument must be polymorphic in `s`, it has to return one and the same type `a` for all states `s`; the result `a` may not depend on the state. Thus, the unwanted code snippet above contains a type error and the compiler will reject it.

You can find a more detailed explanation of the ST monad in the original paper *Lazy functional state threads*¹¹¹².

⁸ <https://en.wikipedia.org/wiki/Hindley-Milner>

⁹ Or enable just `Rank2Types` if you only want to use rank-2 types

¹⁰ <http://www.haskell.org/haskellwiki/Monad/ST>

¹¹ <http://www.dcs.gla.ac.uk/fp/papers/lazy-functional-state-threads.ps.Z>

¹² John Launchbury; Simon Peyton Jones 1994-??-??. *Lazy functional state threads-* ACM Press". pp. 24-35
<http://>

51.1.4 Impredicativity

- *predicative* = type variables instantiated to *monotypes*. *impredicative* = also *polytypes*.
Example: `length [id :: forall a . a -> a]` or `Just (id :: forall a. a -> a)`.
Subtly different from higher-rank.
- relation of polymorphic types by their generality, i.e. ‘`isInstanceOf`’.
- haskell-cafe: RankNTypes short explanation.¹³

51.2 System F

Section goal = a little bit lambda calculus foundation to prevent brain damage from implicit type parameter passing.

- System F = Basis for all this \forall -stuff.
- Explicit type applications i.e. `map Int (+1) [1,2,3]`. \forall similar to the function arrow `->`.
- Terms depend on types. Big Λ for type arguments, small λ for value arguments.

51.3 Examples

Section goal = enable reader to judge whether to use data structures with \forall in his own code.

- Church numerals, Encoding of arbitrary recursive types (positivity conditions): `&forall x. (F x -> x) -> x`
- Continuations, Pattern-matching: `maybe`, `either` and `foldr`

I.e. \forall can be put to good use for implementing data types in Haskell.

51.4 Other forms of Polymorphism

Though we've talked about primarily parametric polymorphism so far, there are actually two predominant forms of polymorphism employed in various language systems:

- **Ad-hoc Polymorphism** - where a function is capable of being applied to a finite number of types.
- **Parametric polymorphism** - where a function is capable of being applied to an infinite number of types.

In C++, ad-hoc polymorphism can be seen as equivalent to function overloading:

```
int square(int x);  
float square(float x);
```

We can do something similar in Haskell using type classes:

```
class Square a where  
  square :: a -> a
```

¹³ <http://thread.gmane.org/gmane.comp.lang.haskell.cafe/40508/focus=40610>

```
instance Square Int where
  square x = x * x
```

```
instance Square Float where
  square x = x * x
```

The main thing to take away with ad-hoc polymorphism is there will always be types that the function cannot accept, though the number of types the function can accept may be infinite.

Contrast this with parametric polymorphism, equivalent in C++ to template functions:

```
template <class T>
T id(T a) {
  return a;
}

template <class A, class B>
A const_(A first, B second) {
  return first;
}

template <class T>
int return10 (T a) {
  return 10;
}
```

Which is equivalent to the following in Haskell:

```
id :: a -> a
id a = a

const :: a -> b -> a
const a _ = a

return10 :: a -> Int
return10 _ = 10
```

The main take-away with parametric polymorphism is that any type must be accepted as an input to the function, regardless of its return type.

Note, with both forms of polymorphism, it is not possible to have two identically named functions that differ only in their return type.

For example, the following C++ is not valid:

```
void square(int x);
int square(int x);
```

Nor the Haskell version:

```
class Square a where
  square :: a -> a

instance Square Int where
  square x = x*x

instance Square Int where
  square x = ()
```

Since the compiler would have no way to determine which version to use given an arbitrary function call.

TODO = contrast polymorphism in OOP and stuff.

- *subtyping*

51.5 Free Theorems

Section goal = enable reader to come up with free theorems. no need to prove them, intuition is enough.

- free theorems for parametric polymorphism.

51.6 See also

- Luca Cardelli. On Understanding Types, Data Abstraction, and Polymorphism¹⁴.

¹⁴ <http://lucacardelli.name/Papers/OnUnderstanding.A4.pdf>

52 Existentially quantified types

Existential types, or 'existentials' for short, are a way of 'squashing' a group of types into one, single type.

Existentials are part of GHC's *type system extensions*. They aren't part of Haskell98, and as such you'll have to either compile any code that contains them with an extra command-line parameter of `-XExistentialQuantification`, or put `{-# LANGUAGE ExistentialQuantification #-}` at the top of your sources that use existentials.

52.1 The forall keyword

The `forall` keyword is used to explicitly bring fresh type variables into scope. For example, consider something you've innocuously seen written a hundred times so far:

Example: A polymorphic function

```
map :: (a -> b) -> [a] -> [b]
```

But what are these `a` and `b`? Well, they're type variables, you answer. The compiler sees that they begin with a lowercase letter and as such allows any type to fill that role. Another way of putting this is that those variables are 'universally quantified'. If you've studied formal logic, you will have undoubtedly come across the quantifiers: 'for all' (or \forall) and 'exists' (or \exists). They 'quantify' whatever comes after them: for example, $\exists x$ means that whatever follows is true for at least one value of x . $\forall x$ means that what follows is true for every possible value of x you can imagine. For example, $\forall x, x^2 \geq 0$ and $\exists x, x^3 = 27$.

The `forall` keyword quantifies *types* in a similar way. We would rewrite `map`'s type as follows:

Example: Explicitly quantifying the type variables

```
map :: forall a b. (a -> b) -> [a] -> [b]
```

So we see that for any combination of types `a` and `b` we can imagine, `map` takes the type `(a -> b) -> [a] -> [b]`. For example, we might choose `a = Int` and `b = String`. Then it's valid to say that `map` has the type `(Int -> String) -> [Int] -> [String]`. Here we are *instantiating* the general type of `map` to a more specific type.

However, in Haskell, any introduction of a lowercase type parameter implicitly begins with a `forall` keyword, so those two previous type declarations for `map` are equivalent, as are the declarations below:

Example: Two equivalent type statements

```
id :: a -> a
id :: forall a . a -> a
```

What makes life really interesting and the `forall` so useful is that you can apply additional constraints on the type variables it introduces. Such constraints, $P(x)$, serve to guarantee certain properties of the type variable, x , as a kind of ad-hoc interface restriction, (similar to $\exists x, P(x)$ or $\forall x, P(x)$ stipulations).

Let's dive right into the deep end of this by seeing an example of the power of existential types in action.

52.2 Example: heterogeneous lists

The premise behind Haskell's type class system is grouping types that all share a common property. So if you know a type that is a member of some class `C`, you know certain things about that type. For example, `Int` is a member of class `Eq`, so we know that elements of `Int` can be compared for equality.

Suppose we have a group of values. We don't know if they are all the same type, but we do know they are all members of some class (and, by extension, that all the values have a certain property). It might be useful to throw all these values into a list. We can't do this normally because lists elements must be of the same type (homogeneous with respect to types). However, existential types allow us to loosen this requirement by defining a 'type hider' or 'type box':

Example: Constructing a heterogeneous list

```
data ShowBox = forall s. Show s => SB s

heteroList :: [ShowBox]
heteroList = [SB (), SB 5, SB True]
```

We won't explain precisely what we mean by that data type definition, but its meaning should be clear to your intuition. The important thing is that we're calling the constructor on three values of different types, `[SB (), SB 5, SB True]`, yet we are able to place them all into a single list, so we must somehow have the same type for each one. Essentially, yes. This is because our use of the `forall` keyword gives our constructor the type `SB :: forall s. Show s => s -> ShowBox`. If we were now writing a function to which we intend to pass `heteroList`, we couldn't apply a function such as `not` to the values inside the `SB` because their type might not be `Bool`. But we do know something about each of the elements: they

can be converted to a string via `show`. In fact, that's pretty much the only thing we know about them.

Example: Using our heterogeneous list

```
instance Show ShowBox where
  show (SB s) = show s      -- (*) see the comment in the text below

f :: [ShowBox] -> IO ()
f xs = mapM_ print xs

main = f heteroList
```

Let's expand on this a bit more. In the definition of `show` for `ShowBox` – the line marked with `(*)` *see the comment in the text below* – we don't know the type of `s`. But as we mentioned, we *do* know that the type is an instance of `Show` due to the constraint on the `SB` constructor. Therefore, it's legal to use the function `show` on `s`, as seen in the right-hand side of the function definition.

As for `f`, recall the type of `print`:

Example: Types of the functions involved

```
print :: Show s => s -> IO () -- print x = putStrLn (show x)
mapM_ :: (a -> m b) -> [a] -> m ()
mapM_ print :: Show s => [s] -> IO ()
```

As we just declared `ShowBox` an instance of `Show`, we can print the values in the list.

52.3 A Further Explanation

One way to think about `forall` is to think about types as a set of possible values. For example, `Bool` is the set $\{\text{True}, \text{False}, \perp\}$ (remember that bottom, \perp , is a member of every type!), `Integer` is the set of integers (and bottom), `String` is the set of all possible strings (and bottom), and so on. `forall` serves as a way to assert a commonality or *intersection* of the specified types (i.e. sets of values). For example, `forall a. a` is the intersection of all types. This subset turns out to be the set whose sole element is bottom, $\{\perp\}$, since it is an implicit value in every type. That is, the type whose only available value is bottom. However, since every Haskell type includes bottom, $\{\perp\}$, this quantification in fact stipulates all Haskell types. However, the only permissible operations on it are those available to a type whose only element is bottom.

A few more examples:

1. The list, `[forall a. a]`, is the type of a list whose elements all have the type `forall a. a`, i.e. a list of bottoms.
2. The list, `[forall a. Show a => a]`, is the type of a list whose elements all have the type `forall a. Show a => a`. The `Show` class constraint requires the possible types

to also be a member of the class, `Show`. However, \perp is still the only value common to all these types, so this too is a list of bottoms.

3. The list, `[forall a. Num a => a]`, requires each element to be a member of the class, `Num`. Consequently, the possible values include numeric literals, which have the specific type, `forall a. Num a => a`, as well as `bottom`.
4. `forall a. [a]` is the type of the list whose elements all have the same type `a`. Since we cannot presume any particular type at all, this too is a list of bottoms.

We see that most intersections over types just lead to bottoms because types generally don't have any values in common and so presumptions cannot be made about a union of their values.

However, recall that in the last section, we developed a heterogeneous list using a 'type hider'. This 'type hider' functions as a wrapper type which guarantees certain facilities by implying a predicate or constraint on the permissible types. In that case it was that they must be a member of the type class `Show`. In general, that seems to be the purpose of `forall`, to impose type constraint on the permissible types within a type declaration and thereby guaranteeing certain facilities with such types.

Let's declare one.

Example: An existential datatype

```
data T = forall a. MkT a
```

This means that:

Example: This defines a polymorphic constructor, or a family of constructors for T

```
MkT :: forall a. (a -> T)
```

So we can pass any type, `a`, we want to `MkT` and it will create a `T`. So what happens when we deconstruct a `T` value with pattern matching...?

Example: Pattern matching on our existential constructor

```
foo (MkT x) = ... -- what is the type of x?
```

As we've just stated, `x` could be of any type. That means it's a member of some arbitrary type, so has the type `forall a. a`. In other words the set whose only available value is `bottom`, \perp .

However, we can make a heterogeneous list:

Example: Constructing the heterogeneous list

```
heteroList = [MkT 5, MkT (), MkT True, MkT map]
```

Of course, when we pattern match on `heteroList` we cannot presume any features about its elements¹. So technically, we can't do anything *useful* with its elements, except reduce them to WHNF.² However, if we introduce class constraints:

Example: A new existential data type, with a class constraint

```
data T' = forall a. Show a => MkT' a
```

The class constraint serves to limit the types we are intersecting over, such that we now have values inside a `T'` which are elements of some arbitrary type *that are members of Show*. The implication of this is that we can apply `show` to a value of type `a` upon deconstruction. It doesn't matter exactly which type it turns out to be.

Example: Using our new heterogeneous setup

```
heteroList' = [MkT' 5, MkT' (), MkT' True, MkT' "Sartre"]
main = mapM_ (\(MkT' x) -> print x) heteroList'

{- prints:
5
()
True
"Sartre"
-}
```

To summarize, the interaction of the universal quantifier with data types produces a qualified subset of types guaranteeing certain facilities as described by one or more class constraints.

52.4 Example: runST

One monad that you may not have come across so far is the `ST` monad. This is essentially a more powerful version of the `State` monad: it has a much more complicated structure and involves some more advanced topics. It was originally written to provide Haskell with IO. As we mentioned in the [../Understanding monads/](#)³ chapter, IO is basically just a `State` monad with an environment of all the information about the real world. In fact, inside GHC at least, `ST` is used, and the environment is a type called `RealWorld`.

-
- 1 However, we can apply them to functions whose type is `forall a. a -> R`, for some arbitrary `R`, as these accept values of any type as a parameter. Examples of such functions: `id`, `const k` for any `k`, `seq`
 - 2 because all we know is that they have some arbitrary type.
 - 3 Chapter 30 on page 189

To get out of the State monad, you can use `runState`. The analogous function for `ST` is called `runST`, and it has a rather particular type:

Example: The `runST` function

```
runST :: forall a. (forall s. ST s a) -> a
```

This is actually an example of a more complicated language feature called rank-2 polymorphism, which we don't go into detail here. It's important to notice that there is no parameter for the initial state. Indeed, `ST` uses a different notion of state to `State`; while `State` allows you to `get` and `put` the current state, `ST` provides an interface to *references*. You create references, which have type `STRef`, with `newSTRef :: a -> ST s (STRef s a)`, providing an initial value, then you can use `readSTRef :: STRef s a -> ST s a` and `writeSTRef :: STRef s a -> a -> ST s ()` to manipulate them. As such, the internal environment of a `ST` computation is not one specific value, but a mapping from references to values. Therefore, you don't need to provide an initial state to `runST`, as the initial state is just the empty mapping containing no references.

However, things aren't quite as simple as this. What stops you creating a reference in one `ST` computation, then using it in another? We don't want to allow this because (for reasons of thread-safety) no `ST` computation should be allowed to assume that the initial internal environment contains any specific references. More concretely, we want the following code to be invalid:

Example: Bad `ST` code

```
let v = runST (newSTRef True)
in runST (readSTRef v)
```

What would prevent this? The effect of the rank-2 polymorphism in `runST`'s type is to *constrain the scope of the type variable `s`* to be within the first parameter. In other words, if the type variable `s` appears in the first parameter it cannot also appear in the second. Let's take a look at how exactly this is done. Say we have some code like the following:

Example: Briefer bad `ST` code

```
... runST (newSTRef True) ...
```

The compiler tries to fit the types together:

Example: The compiler's typechecking stage

```
newSTRef True :: forall s. ST s (STRef s Bool)
runST :: forall a. (forall s. ST s a) -> a
together, (forall s. ST s (STRef s Bool)) -> STRef s Bool
```

The importance of the `forall` in the first bracket is that we can change the name of the `s`. That is, we could write:

Example: A type mismatch!

```
together, (forall s'. ST s' (STRef s' Bool)) -> STRef s Bool
```

This makes sense: in mathematics, saying $\forall x.x > 5$ is precisely the same as saying $\forall y.y > 5$; you're just giving the variable a different label. However, we have a problem with our above code. Notice that as the `forall` does *not* scope over the return type of `runST`, we don't rename the `s` there as well. But suddenly, we've got a type mismatch! The result type of the `ST` computation in the first parameter must match the result type of `runST`, but now it doesn't!

The key feature of the existential is that it allows the compiler to generalise the type of the state in the first parameter, and so the result type cannot depend on it. This neatly sidesteps our dependence problems, and 'compartmentalises' each call to `runST` into its own little heap, with references not being able to be shared between different calls.

52.5 Quantified Types as Products and Sums

A universally quantified type may be interpreted as an infinite product of types. For instance, a polymorphic function like:

Example: Identity function

```
id :: forall a. a -> a
id a = a
```

can be understood as a product, or a tuple, of individual functions, one per every possible type `a`. To construct a value of such type, we have to provide all the components of the tuple at once. In case of function types, this is possible because of polymorphism -- one formula generating an infinity of functions.

In case of numeric types, one numeric constant may be used to initialize multiple types at once. For instance, in:

Example: Polymorphic value

```
x :: forall a. Num a => a
x = 0
```

`x` may be conceptualized as a tuple consisting of an `Int` value, a `Double` value, etc.

Similarly, an existentially quantified type may be interpreted as an infinite sum. For instance,

Example: Existential type

```
data ShowBox = forall s. Show s => SB s
```

may be conceptualized as a sum:

Example: Sum type

```
data ShowBox = SBUnit | SBInt Int | SBBool Bool | SBIntList [Int] | ...
```

To construct a value of this type, we only have to pick one of the constructors. A polymorphic constructor `SB` combines all those constructors into one.

52.6 Quantification as a primitive

Universal quantification is useful for defining data types that aren't already defined. Suppose there was no such thing as pairs built into Haskell. Quantification could be used to define them.

```
{-# LANGUAGE ExistentialQuantification, RankNTypes #-}

newtype Pair a b = Pair (forall c. (a -> b -> c) -> c)

makePair :: a -> b -> Pair a b
makePair a b = Pair $ \f -> f a b
```

In GHCi:

```
λ> :set -XExistentialQuantification
λ> :set -XRankNTypes
λ> newtype Pair a b = Pair {runPair :: forall c. (a -> b -> c) -> c}
λ> makePair a b = Pair $ \f -> f a b
λ> pair = makePair "a" 'b'

λ> :t pair
pair :: Pair [Char] Char
```

```
λ> runPair pair (\x y -> x)
"a"

λ> runPair pair (\x y -> y)
'b'
```

52.7 Further reading

- 24 Days of GHC Extensions: Existential Quantification⁴
- GHC's user guide contains useful information⁵ on existentials, including the various limitations placed on them (which you should know about).
- *Lazy Functional State Threads*⁶, by Simon Peyton-Jones and John Launchbury, is a paper which explains more fully the ideas behind ST.

4 <https://ocharles.org.uk/blog/guest-posts/2014-12-19-existential-quantification.html>

5 https://downloads.haskell.org/~ghc/latest/docs/html/users_guide/glasgow_exts.html#existentially-quantified-data-constructors

6 <http://citeseerx.ist.psu.edu/viewdoc/summary?doi=10.1.1.50.3299>

53 Advanced type classes

Type classes may seem innocuous, but research on the subject has resulted in several advancements and generalisations which make them a very powerful tool.

53.1 Multi-parameter type classes

Multi-parameter type classes are a generalisation of the single parameter type classes¹, and are supported by some Haskell implementations.

Suppose we wanted to create a 'Collection' type class that could be used with a variety of concrete data types, and supports two operations -- 'insert' for adding elements, and 'member' for testing membership. A first attempt might look like this:

Example: The Collection type class (wrong)

```
class Collection c where
  insert :: c -> e -> c
  member :: c -> e -> Bool

-- Make lists an instance of Collection:
instance Collection [a] where
  insert xs x = x:xs
  member = flip elem
```

This won't compile, however. The problem is that the 'e' type variable in the Collection operations comes from nowhere -- there is nothing in the type of an instance of Collection that will tell us what the 'e' actually is, so we can never define implementations of these methods. Multi-parameter type classes solve this by allowing us to put 'e' into the type of the class. Here is an example that compiles and can be used:

Example: The Collection type class (right)

```
{-# LANGUAGE FlexibleInstances #-}
{-# LANGUAGE MultiParamTypeClasses #-}
class Eq e => Collection c e where
  insert :: c -> e -> c
  member :: c -> e -> Bool

instance Eq a => Collection [a] a where
  insert = flip (:)
  member = flip elem
```

¹ <https://en.wikibooks.org/wiki/Classes%20and%20types>

53.2 Functional dependencies

A problem with the above example is that, in this case, we have extra information that the compiler doesn't know, which can lead to false ambiguities and over-generalised function signatures. In this case, we can see intuitively that the type of the collection will always determine the type of the element it contains - so if `c` is `[a]`, then `e` will be `a`. If `c` is `HashMap a`, then `e` will be `a`. (The reverse is not true: many different collection types can hold the same element type, so knowing the element type was e.g. `Int`, would not tell you the collection type).

In order to tell the compiler this information, we add a **functional dependency**, changing the class declaration to

Example: A functional dependency

```
class Eq e => Collection c e | c -> e where ...
```

A functional dependency is a constraint that we can place on type class parameters. Here, the extra `| c -> e` should be read 'c uniquely identifies e', meaning for a given `c`, there will only be one `e`. You can have more than one functional dependency in a class -- for example you could have `c -> e`, `e -> c` in the above case. And you can have more than two parameters in multi-parameter classes.

53.2.1 Examples

Matrices and vectors

Suppose you want to implement some code to perform simple linear algebra:

Example: The Vector and Matrix datatypes

```
data Vector = Vector Int Int deriving (Eq, Show)
data Matrix = Matrix Vector Vector deriving (Eq, Show)
```

You want these to behave as much like numbers as possible. So you might start by overloading Haskell's `Num` class:

Example: Instance declarations for Vector and Matrix

```
instance Num Vector where
  Vector a1 b1 + Vector a2 b2 = Vector (a1+a2) (b1+b2)
  Vector a1 b1 - Vector a2 b2 = Vector (a1-a2) (b1-b2)
  {- ... and so on ... -}

instance Num Matrix where
  Matrix a1 b1 + Matrix a2 b2 = Matrix (a1+a2) (b1+b2)
  Matrix a1 b1 - Matrix a2 b2 = Matrix (a1-a2) (b1-b2)
  {- ... and so on ... -}
```

The problem comes when you want to start multiplying quantities. You really need a multiplication function which overloads to different types:

Example: What we need

```
(*) :: Matrix -> Matrix -> Matrix
(*) :: Matrix -> Vector -> Vector
(*) :: Matrix -> Int -> Matrix
(*) :: Int -> Matrix -> Matrix
{- ... and so on ... -}
```

How do we specify a type class which allows all these possibilities?

We could try this:

Example: An ineffective attempt (too general)

```
class Mult a b c where
  (*) :: a -> b -> c

instance Mult Matrix Matrix Matrix where
  {- ... -}

instance Mult Matrix Vector Vector where
  {- ... -}
```

That, however, isn't really what we want. As it stands, even a simple expression like this has an ambiguous type unless you supply an additional type declaration on the intermediate expression:

Example: Ambiguities lead to more verbose code

```
m1, m2, m3 :: Matrix
(m1 * m2) * m3      -- type error; type of (m1*m2) is ambiguous
(m1 * m2) :: Matrix * m3  -- this is ok
```

After all, nothing is stopping someone from coming along later and adding another instance:

Example: A nonsensical instance of Mult

```
instance Mult Matrix Matrix (Maybe Char) where
  {- whatever -}
```

The problem is that `c` shouldn't really be a free type variable. When you know the types of the things that you're multiplying, the result type should be determined from that information alone.

You can express this by specifying a functional dependency:

Example: The correct definition of Mult

```
class Mult a b c | a b -> c where  
  (*) :: a -> b -> c
```

This tells Haskell that c is uniquely determined from a and b .

54 Phantom types

Phantom types are a way to embed a language with a stronger type system than Haskell's.

54.1 Phantom types

An ordinary type

```
data T = TI Int | TS String
```

```
plus :: T -> T -> T
concat :: T -> T -> T
```

its phantom type version

```
data T a = TI Int | TS String
```

Nothing's changed - just a new argument `a` that we don't touch. But magic!

```
plus :: T Int -> T Int -> T Int
concat :: T String -> T String -> T String
```

Now we can enforce a little bit more!

This is useful if you want to increase the type-safety of your code, but not impose additional runtime overhead:

```
-- Peano numbers at the type level.
data Zero = Zero
data Succ a = Succ a
-- Example: 3 can be modeled as the type
-- Succ (Succ (Succ Zero))

type D2 = Succ (Succ Zero)
type D3 = Succ (Succ (Succ Zero))

data Vector n a = Vector [a] deriving (Eq, Show)

vector2d :: Vector D2 Int
vector2d = Vector [1,2]

vector3d :: Vector D3 Int
vector3d = Vector [1,2,3]

-- vector2d == vector3d raises a type error
-- at compile-time:

-- Couldn't match expected type `Zero'
--   with actual type `Succ Zero'
-- Expected type: Vector D2 Int
-- Actual type: Vector D3 Int
```

```
-- In the second argument of `(==)', namely `vector3d`  
-- In the expression: vector2d == vector3d  
  
-- while vector2d == Vector [1,2,3] works
```

55 Generalised algebraic data-types (GADT)

w:Generalized algebraic data type¹

Generalized algebraic datatypes, or simply GADTs, are a generalization of the algebraic data types that you are familiar with. Basically, they allow you to explicitly write down the types of the constructors. In this chapter, you'll learn why this is useful and how to declare your own.

We begin with an example of building a simple embedded domain specific language (EDSL) for simple arithmetical expressions, which is put on a sounder footing with GADTs. This is followed by a review of the syntax for GADTs, with simpler illustrations, and a different application to construct a safe list type for which the equivalent of `head []` fails to typecheck and thus does not give the usual runtime error: `*** Exception: Prelude.head: empty list`.

55.1 Understanding GADTs

So, what are GADTs and what are they useful for? GADTs are mainly used to implement domain specific languages, and so this section will introduce them with a corresponding example.

55.1.1 Arithmetic expressions

Let's consider a small language for arithmetic expressions, given by the data type

```
data Expr = I Int           -- integer constants
          | Add Expr Expr   -- add two expressions
          | Mul Expr Expr   -- multiply two expressions
```

In other words, this data type corresponds to the abstract syntax tree, an arithmetic term like $(5+1)*7$ would be represented as `(I 5 `Add` I 1) `Mul` I 7 :: Expr`.

Given the abstract syntax tree, we would like to do something with it; we want to compile it, optimize it and so on. For starters, let's write an evaluation function that takes an expression and calculates the integer value it represents. The definition is straightforward:

```
eval :: Expr -> Int
eval (I n)      = n
eval (Add e1 e2) = eval e1 + eval e2
eval (Mul e1 e2) = eval e1 * eval e2
```

¹ <https://en.wikipedia.org/wiki/Generalized%20algebraic%20data%20type>

55.1.2 Extending the language

Now, imagine that we would like to extend our language with other types than just integers. For instance, let's say we want to represent equality tests, so we need booleans as well. We augment the 'Expr' type to become

```
data Expr = I Int
          | B Bool           -- boolean constants
          | Add Expr Expr
          | Mul Expr Expr
          | Eq  Expr Expr    -- equality test
```

The term `5+1 == 7` would be represented as `(I 5 `Add` I 1) `Eq` I 7`.

As before, we want to write a function `eval` to evaluate expressions. But this time, expressions can now represent either integers or booleans and we have to capture that in the return type

```
eval :: Expr -> Either Int Bool
```

The first two cases are straightforward

```
eval (I n) = Left n
eval (B b) = Right b
```

but now we get in trouble. We would like to write

```
eval (Add e1 e2) = eval e1 + eval e2 -- ???
```

but this doesn't type check: the addition function `+` expects two integer arguments, but `eval e1` is of type `Either Int Bool` and we'd have to extract the `Int` from that.

Even worse, what happens if `e1` actually represents a *boolean*? The following is a valid expression

```
B True `Add` I 5 :: Expr
```

but clearly, it doesn't make any sense; we can't add booleans to integers! In other words, evaluation may return integers or booleans, but it may also *fail* because the expression makes no sense. We have to incorporate that in the return type:

```
eval :: Expr -> Maybe (Either Int Bool)
```

Now, we could write this function just fine, but that would still be unsatisfactory, because what we *really* want to do is to have Haskell's type system rule out any invalid expressions; we don't want to check types ourselves while deconstructing the abstract syntax tree.

Exercise: Despite our goal, it may still be instructional to implement the `eval` function; do this.

Starting point:

```
data Expr = I Int
          | B Bool           -- boolean constants
          | Add Expr Expr
          | Mul Expr Expr
```



```

    | Eq Expr Expr -- equality test

eval :: Expr -> Maybe (Either Int Bool)
-- Your implementation here.

```

55.1.3 Phantom types

The so-called *phantom types* are the first step towards our goal. The technique is to augment the `Expr` with a type variable, so that it becomes

```

data Expr a = I Int
            | B Bool
            | Add (Expr a) (Expr a)
            | Mul (Expr a) (Expr a)
            | Eq (Expr a) (Expr a)

```

Note that an expression `Expr a` does not contain a value `a` at all; that's why `a` is called a *phantom type*, it's just a dummy variable. Compare that with, say, a list `[a]` which does contain a bunch of `as`.

The key idea is that we're going to use `a` to track the type of the expression for us. Instead of making the constructor

```
Add :: Expr a -> Expr a -> Expr a
```

available to users of our small language, we are only going to provide a *smart constructor* with a more restricted type

```
add :: Expr Int -> Expr Int -> Expr Int
add = Add

```

The implementation is the same, but the types are different. Doing this with the other constructors as well,

```

i :: Int -> Expr Int
i = I

b :: Bool -> Expr Bool
b = B

```

the previously problematic expression

```
b True `add` i 5
```

no longer type checks! After all, the first argument has the type `Expr Bool` while `add` expects an `Expr Int`. In other words, the phantom type `a` marks the intended type of the expression. By only exporting the smart constructors, the user cannot create expressions with incorrect types.

As before, we want to implement an evaluation function. With our new marker `a`, we might hope to give it the type

```
eval :: Expr a -> a
```

and implement the first case like this

```
eval (I n) = n
```

But alas, this does not work: how would the compiler know that encountering the constructor `I` means that `a = Int`? Granted, this will be the case for all expressions that were created by users of our language because they are only allowed to use the smart constructors. But internally, an expression like

```
I 5 :: Expr String
```

is still valid. In fact, as you can see, `a` doesn't even have to be `Int` or `Bool`, it could be anything.

What we need is a way to restrict the return types of the constructors themselves, and that's exactly what generalized data types do.

55.1.4 GADTs

The obvious notation for restricting the type of a constructor is to write down its type, and that's exactly how GADTs are defined:

```
data Expr a where
  I  :: Int  -> Expr Int
  B  :: Bool -> Expr Bool
  Add :: Expr Int -> Expr Int -> Expr Int
  Mul :: Expr Int -> Expr Int -> Expr Int
  Eq  :: Eq a => Expr a -> Expr a -> Expr Bool
```

In other words, we simply list the type signatures of all the constructors. In particular, the marker type `a` is specialised to `Int` or `Bool` according to our needs, just like we would have done with smart constructors.

And the great thing about GADTs is that we now *can* implement an evaluation function that takes advantage of the type marker:

```
eval :: Expr a -> a
eval (I n) = n
eval (B b) = b
eval (Add e1 e2) = eval e1 + eval e2
eval (Mul e1 e2) = eval e1 * eval e2
eval (Eq e1 e2) = eval e1 == eval e2
```

In particular, in the first case

```
eval (I n) = n
```

the compiler is now able infer that `a=Int` when we encounter a constructor `I` and that it is legal to return the `n :: Int`; similarly for the other cases.

To summarise, GADTs allows us to restrict the return types of constructors and thus enable us to take advantage of Haskell's type system for our domain specific languages. Thus, we can implement more languages and their implementation becomes simpler.

55.2 Summary

55.2.1 Syntax

Here a quick summary of how the syntax for declaring GADTs works.

First, consider the following ordinary algebraic datatypes: the familiar `List` and `Maybe` types, and a simple tree type, `RoseTree`:

Maybe	List	Rose Tree
<pre>data Maybe a = Nothing Just a</pre>	<pre>data List a = Nil Cons a (List a)</pre>	<pre>data RoseTree a = RoseTree a [RoseTree a]</pre>

Remember that the constructors introduced by these declarations can be used both for pattern matches to deconstruct values and as functions to construct values. (`Nothing` and `Nil` are functions with "zero arguments".) We can ask what the types of the latter are:

Maybe	List	Rose Tree
<pre>> :t Nothing Nothing :: Maybe a > :t Just Just :: a -> Maybe a</pre>	<pre>> :t Nil Nil :: List a > :t Cons Cons :: a -> List a -> List a</pre>	<pre>> :t RoseTree RoseTree :: a -> [RoseTree a] -> RoseTree a</pre>

It is clear that this type information about the constructors for `Maybe`, `List` and `RoseTree` respectively is equivalent to the information we gave to the compiler when declaring the datatype in the first place. In other words, it's also conceivable to declare a datatype by simply listing the types of all of its constructors, and that's exactly what the GADT syntax does:

Maybe	List	Rose Tree
<pre>data Maybe a where Nothing :: Maybe a Just :: a -> Maybe a</pre>	<pre>data List a where Nil :: List a Cons :: a -> List a -> List a</pre>	<pre>data RoseTree a where RoseTree :: a -> [RoseTree a] -> RoseTree a</pre>

This syntax is made available by the language option `{-#LANGUAGE GADTs #-}`. It should be familiar to you in that it closely resembles the syntax of type class declarations. It's also easy to remember if you already like to think of constructors as just being functions. Each constructor is just defined by a type signature.

55.2.2 New possibilities

Note that when we asked the `GHCi` for the types of `Nothing` and `Just` it returned `Maybe a` and `a -> Maybe a` as the types. In these and the other cases, the type of the final output of the function associated with a constructor is the type we were initially defining - `Maybe a`, `List a` or `RoseTree a`. In general, in standard Haskell, the constructor functions for `Foo`

a have `Foo a` as their final return type. If the new syntax were to be strictly equivalent to the old, we would have to place this restriction on its use for valid type declarations.

So what do GADTs add for us? The ability to control exactly what kind of `Foo` you return. With GADTs, a constructor for `Foo a` is not obliged to return `Foo a`; it can return any `Foo blah` that you can think of. In the code sample below, for instance, the `MkTrueGadtFoo` constructor returns a `TrueGadtFoo Int` even though it is for the type `TrueGadtFoo a`.

Example: GADT gives you more control:

```
data FooInGadtClothing a where
  MkFooInGadtClothing :: a -> FooInGadtClothing a

--which is no different from: data Haskell98Foo a = MkHaskell98Foo a ,

--by contrast, consider:

data TrueGadtFoo a where
  MkTrueGadtFoo :: a -> TrueGadtFoo Int

--This has no Haskell 98 equivalent.
```

But note that you can only push the generalization so far... if the datatype you are declaring is a `Foo`, the constructor functions *must* return some kind of `Foo` or another. Returning anything else simply wouldn't work.

Example: Try this out. It doesn't work:

```
data Bar where
  BarNone :: Bar -- This is ok

data Foo where
  MkFoo :: Bar Int -- This will not typecheck
```

55.3 Examples

55.3.1 Safe Lists

Prerequisite: *We assume in this section that you know how a `List` tends to be represented in functional languages*

Note: *The examples in this section additionally require the extensions `EmptyDataDecls` and `KindSignatures` to be enabled*

We've now gotten a glimpse of the extra control given to us by the GADT syntax. The only thing new is that you can control exactly what kind of data structure you return. Now, what can we use it for? Consider the humble Haskell list. What happens when you invoke

`head []`? Haskell blows up. Have you ever wished you could have a magical version of `head` that only accepts lists with at least one element, lists on which it will never blow up?

To begin with, let's define a new type, `SafeList x y`. The idea is to have something similar to normal Haskell lists `[x]`, but with a little extra information in the type. This extra information (the type variable `y`) tells us whether or not the list is empty. Empty lists are represented as `SafeList x Empty`, whereas non-empty lists are represented as `SafeList x NonEmpty`.

```
-- we have to define these types
data Empty
data NonEmpty

-- the idea is that you can have either
--   SafeList a Empty
-- or SafeList a NonEmpty
data SafeList a b where
-- to be implemented
```

Since we have this extra information, we can now define a function `safeHead` on only the non-empty lists! Calling `safeHead` on an empty list would simply refuse to type-check.

```
safeHead :: SafeList a NonEmpty -> a
```

So now that we know what we want, `safeHead`, how do we actually go about getting it? The answer is GADT. The key is that we take advantage of the GADT feature to return two *different* list-of-a types, `SafeList a Empty` for the `Nil` constructor, and `SafeList a NonEmpty` for the `Cons` constructor:

```
data SafeList a b where
  Nil  :: SafeList a Empty
  Cons :: a -> SafeList a b -> SafeList a NonEmpty
```

This wouldn't have been possible without GADT, because all of our constructors would have been required to return the same type of list; whereas with GADT we can now return different types of lists with different constructors. Anyway, let's put this all together, along with the actual definition of `SafeHead`:

Example: safe lists via GADT

```

{-LANGUAGE GADTs, EmptyDataDecls -}
-- (the EmptyDataDecls pragma must also appear at the very top of the module,
-- in order to allow the Empty and NonEmpty datatype declarations.)

data Empty
data NonEmpty

data SafeList a b where
  Nil :: SafeList a Empty
  Cons :: a -> SafeList a b -> SafeList a NonEmpty

safeHead :: SafeList a NonEmpty -> a
safeHead (Cons x _) = x

```

Copy this listing into a file and load in `ghci -fglasgow-exts`. You should notice the following difference, calling `safeHead` on a non-empty and an empty-list respectively:

Example: safeHead is... safe

```

Prelude Main> safeHead (Cons "hi" Nil)
"hi"
Prelude Main> safeHead Nil

<interactive>:1:9:
  Couldn't match `NonEmpty' against `Empty'
    Expected type: SafeList a NonEmpty
    Inferred type: SafeList a Empty
  In the first argument of `safeHead', namely `Nil'
  In the definition of `it': it = safeHead Nil

```

The complaint is a good thing: it means that we can now ensure during compile-time if we're calling `safeHead` on an appropriate list. However, that also sets up a pitfall in potential. Consider the following function. What do you think its type is?

Example: Trouble with GADTs

```

silly False = Nil
silly True  = Cons () Nil

```

Now try loading the example up in GHCi. You'll notice the following complaint:

Example: Trouble with GADTs - the complaint

```

Couldn't match `Empty' against `NonEmpty'
  Expected type: SafeList () Empty
  Inferred type: SafeList () NonEmpty
In the application `Cons () Nil'
In the definition of `silly': silly True = Cons () Nil

```

The cases in the definition of `silly` evaluate to marked lists of different types, leading to a type error. The extra constraints imposed through the GADT make it impossible for a function to produce both empty and non-empty lists.

If we are really keen on defining `silly`, we can do so by liberalizing the type of `Cons`, so that it can construct both safe and unsafe lists.

Example: A different approach

```

{-LANGUAGE GADTs, EmptyDataDecls, KindSignatures -}
-- here we add the KindSignatures pragma,
-- which makes the GADT declaration a bit more elegant.

-- Note the subtle yet revealing change in the phantom type names.
data NotSafe
data Safe

data MarkedList          :: * -> * -> * where
  Nil                    :: MarkedList t NotSafe
  Cons                   :: a -> MarkedList a b -> MarkedList a c

safeHead                 :: MarkedList a Safe -> a
safeHead (Cons x _)     = x

-- This function will never produce anything that can be consumed by safeHead,
-- no matter that the resulting list is not necessarily empty.
silly                    :: Bool -> MarkedList () NotSafe
silly False              = Nil
silly True               = Cons () Nil

```

There is a cost to the fix above: by relaxing the constraint on `Cons` we throw away the knowledge that it cannot produce an empty list. Based on our first version of the safe list we could, for instance, define a function which took a `SafeList a Empty` argument and be sure anything produced by `Cons` would not be accepted by it. That does not hold for the analogous `MarkedList a NotSafe`; arguably, the type is less useful exactly because it is less restrictive. While in this example the issue may seem minor, given that not much can be done with an empty list, in general it is worth considering.

Exercises:

1. Could you implement a `safeTail` function? Both versions introduced here would count as valid starting material, as well as any other variants in similar spirit.

55.3.2 A simple expression evaluator

Insert the example used in Wobbly Types paper... I thought that was quite pedagogical

This is already covered in the first part of the tutorial.

55.4 Discussion

More examples, thoughts

From FOSDEM 2006, I vaguely recall that there is some relationship between GADT and the below... what?

55.4.1 Phantom types

See `../Phantom types/`².

55.4.2 Existential types

If you like `../Existentially quantified types/`³, you'd probably want to notice that they are now subsumed by GADTs. As the GHC manual says, the following two type declarations give you the same thing.

```
data TE a = forall b. MkTE b (b->a)
data TG a where { MkTG :: b -> (b->a) -> TG a }
```

55.4.3 Witness types

² Chapter 54 on page 401

³ Chapter 52 on page 387

56 Type constructors & Kinds

56.1 Kinds for C++ users

- `*` is any concrete type, including functions. These all have kind `*`:

```
type MyType = Int
type MyFuncType = Int -> Int
myFunc :: Int -> Int
```

```
typedef int MyType;
typedef int (*MyFuncType)(int);
int MyFunc(int a);
```

- `* -> *` is a template that takes one type argument. It is like a function from types to types: you plug a type in and the result is a type. Confusion can arise from the two uses of `MyData` (although you can give them different names if you wish) - the first is a type constructor, the second is a data constructor. These are equivalent to a class template and a constructor respectively in C++. Context resolves the ambiguity - where Haskell expects a type (e.g. in a type signature) `MyData` is a type constructor, where a value, it is a data constructor.

```
data MyData t -- type constructor with kind * -> *
              = MyData t -- data constructor with type a -> MyData a
*Main> :k MyData
MyData :: * -> *
*Main> :t MyData
MyData :: a -> MyData a
```

```
template <typename t> class MyData
{
    t member;
};
```

- `* -> * -> *` is a template that takes two type arguments

```
data MyData t1 t2 = MyData t1 t2
```

```
template <typename t1, typename t2> class MyData
{
    t1 member1;
    t2 member2;
    MyData(t1 m1, t2 m2) : member1(m1), member2(m2) { }
};
```

- `(* -> *) -> *` is a template that takes one template argument of kind `(* -> *)`

```
data MyData tmpl = MyData (tmpl Int)
```

```
template <template <typename t> class tmp> class MyData
{
    tmp<int> member1;
    MyData(tmp<int> m) : member1(m) { }
};
```

57 Wider Theory

58 Denotational semantics

New readers: Please report stumbling blocks! While the material on this page is intended to explain clearly, there are always mental traps that innocent readers new to the subject fall in but that the authors are not aware of. Please report any tricky passages to the Talk¹ page or the #haskell IRC channel so that the style of exposition can be improved.

58.1 Introduction

This chapter explains how to formalize the meaning of Haskell programs, the **denotational semantics**. It may seem to be nit-picking to formally specify that the program `square x = x*x` means the same as the mathematical square function that maps each number to its square, but what about the meaning of a program like `f x = f (x+1)` that loops forever? In the following, we will exemplify the approach first taken by Scott and Strachey to this question and obtain a foundation to reason about the correctness of functional programs in general and recursive definitions in particular. Of course, we will concentrate on those topics needed to understand Haskell programs.²

Another aim of this chapter is to illustrate the notions **strict** and **lazy** that capture the idea that a function needs or needs not to evaluate its argument. This is a basic ingredient to predict the course of evaluation of Haskell programs and hence of primary interest to the programmer. Interestingly, these notions can be formulated concisely with denotational semantics alone, no reference to an execution model is necessary. They will be put to good use in Graph Reduction³, but it is this chapter that will familiarize the reader with the denotational definition and involved notions such as \perp ("Bottom"). The reader only interested in strictness may wish to poke around in section Bottom and Partial Functions⁴ and quickly head over to Strict and Non-Strict Semantics⁵.

58.1.1 What is Denotational Semantics and what is it for?

What does a Haskell program mean? This question is answered by the **denotational semantics** of Haskell. In general, the denotational semantics of a programming language maps each of its programs to a mathematical object (denotation), that represents the *meaning* of the program in question. As an example, the mathematical object for the

² In fact, there are no written down and complete denotational semantics of Haskell. This would be a tedious task void of additional insight and we happily embrace the folklore and common sense semantics.

³ Chapter 65 on page 487

⁴ Chapter 58.2 on page 420

⁵ Chapter 58.4 on page 429

Haskell programs `10`, `9+1`, `2*5` and `sum [1..4]` can be represented by the integer `10`. We say that all those programs **denote** the integer `10`. The collection of such mathematical objects is called the **semantic domain**.

The mapping from program code to a semantic domain is commonly written down with double square brackets ("Oxford brackets") around program code. For example,

$$[[2*5]] = 10.$$

Denotations are *compositional*, i.e. the meaning of a program like `1+9` only depends on the meaning of its constituents:

$$[[a+b]] = [[a]] + [[b]].$$

The same notation is used for types, i.e.

$$[[\text{Integer}]] = \mathbb{Z}.$$

For simplicity however, we will silently identify expressions with their semantic objects in subsequent chapters and use this notation only when clarification is needed.

It is one of the key properties of *purely functional* languages like Haskell that a direct mathematical interpretation like "`1+9` denotes `10`" carries over to functions, too: in essence, the denotation of a program of type `Integer -> Integer` is a mathematical function $\mathbb{Z} \rightarrow \mathbb{Z}$ between integers. While we will see that this expression needs refinement generally, to include non-termination, the situation for *imperative languages* is clearly worse: a procedure with that type denotes something that changes the state of a machine in possibly unintended ways. Imperative languages are tightly tied to **operational semantics** which describes their way of execution on a machine. It is possible to define a denotational semantics for imperative programs and to use it to reason about such programs, but the semantics often has operational nature and sometimes must be extended in comparison to the denotational semantics for functional languages.⁶ In contrast, the meaning of purely functional languages is *by default* completely independent from their way of execution. The Haskell98 standard even goes as far as to specify only Haskell's non-strict denotational semantics, leaving open how to implement them.

In the end, denotational semantics enables us to develop formal proofs that programs indeed do what we want them to do mathematically. Ironically, for proving program properties in day-to-day Haskell, one can use Equational reasoning⁷, which transforms programs into

⁶ Monads are one of the most successful ways to give denotational semantics to imperative programs. See also Haskell/Advanced monads [^]<https://en.wikibooks.org/wiki/Haskell%2FAdvanced%20monads> .

⁷ <https://en.wikibooks.org/wiki/Haskell%2FEquational%20reasoning>

equivalent ones without seeing much of the underlying mathematical objects we are concentrating on in this chapter. But the denotational semantics actually show up whenever we have to reason about non-terminating programs, for instance in Infinite Lists⁸.

Of course, because they only state what a program is, denotational semantics cannot answer questions about how long a program takes or how much memory it eats; this is governed by the *evaluation strategy* which dictates how the computer calculates the normal form of an expression. On the other hand, the implementation has to respect the semantics, and to a certain extent, it is the semantics that determines how Haskell programs must be evaluated on a machine. We will elaborate on this in Strict and Non-Strict Semantics⁹.

58.1.2 What to choose as Semantic Domain?

We are now looking for suitable mathematical objects that we can attribute to every Haskell program. In case of the example `10, 2*5` and `sum [1..4]`, it is clear that all expressions should denote the integer `10`. Generalizing, every value `x` of type `Integer` is likely to denote an element of the set \mathbb{Z} . The same can be done with values of type `Bool`. For functions like `f :: Integer -> Integer`, we can appeal to the mathematical definition of "function" as a set of (argument,value)-pairs, its *graph*.

But interpreting functions as their graph was too quick, because it does not work well with recursive definitions. Consider the definition

```
shaves :: Integer -> Integer -> Bool
1 `shaves` 1 = True
2 `shaves` 2 = False
0 `shaves` x = not (x `shaves` x)
_ `shaves` _ = False
```

We can think of `0,1` and `2` as being male persons with long beards and the question is who shaves whom. Person `1` shaves himself, but `2` gets shaved by the barber `0` because evaluating the third equation yields `0 `shaves` 2 == True`. In general, the third line says that the barber `0` shaves all persons that do not shave themselves.

What about the barber himself, is `0 `shaves` 0` true or not? If it is, then the third equation says that it is not. If it is not, then the third equation says that it is. Puzzled, we see that we just cannot attribute `True` or `False` to `0 `shaves` 0`; the graph we use as interpretation for the function `shaves` must have an empty spot. We realize that our semantic objects must be able to incorporate **partial functions**, functions that are undefined for some values of their arguments (..that is otherwise permitted by the arguments' types).

It is well known that this famous example gave rise to serious foundational problems in set theory. It's an example of an **impredicative** definition, a definition which uses itself, a logical circle. Unfortunately for recursive definitions, the circle is not the problem but the feature.

⁸ Chapter 58.5.3 on page 436

⁹ Chapter 58.4 on page 429

58.2 Bottom and Partial Functions

58.2.1 \perp Bottom

To define partial functions, we introduce a special value \perp , named **bottom**¹⁰ and commonly written `_|_` in typewriter font. We say that \perp is the completely **”undefined” value or function**. Every basic data type like `Integer` or `()` contains one \perp besides their usual elements. So the possible values of type `Integer` are

$$\perp, 0, +1, -1, +2, -2, +3, -3, \dots$$

Adding \perp to the set of values is also called **lifting**. This is often depicted by a subscript like in \mathbb{Z}_\perp . While this is the correct notation for the mathematical set ”lifted integers”, we prefer to talk about ”values of type `Integer`”. We do this because \mathbb{Z}_\perp suggests that there are ”real” integers \mathbb{Z} , but inside Haskell, the ”integers” are `Integer`.

As another example, the type `()` with only one element actually has two inhabitants:

$$\perp, ()$$

For now, we will stick to programming with `Integers`. Arbitrary algebraic data types will be treated in section Algebraic Data Types¹¹ since strict and non-strict languages diverge on how these include \perp .

In Haskell, the expression `undefined` denotes \perp . With its help, one can indeed verify some semantic properties of actual Haskell programs. `undefined` has the polymorphic type `forall a . a` which of course can be specialized to `undefined :: Integer`, `undefined :: ()`, `undefined :: Integer -> Integer` and so on. In the Haskell Prelude, it is defined as

```
undefined = error "Prelude.undefined"
```

As a side note, it follows from the Curry-Howard isomorphism¹² that any value of the polymorphic type `forall a . a` must denote \perp .

58.2.2 Partial Functions and the Semantic Approximation Order

Now, \perp gives us the possibility to have partial functions:

$$f(n) = \begin{cases} 1 & \text{if } n \text{ is } 0 \\ -2 & \text{if } n \text{ is } 1 \\ \perp & \text{else} \end{cases}$$

¹⁰ <https://en.wikibooks.org/wiki/%3Aw%3ABottom%20type>

¹¹ Chapter 58.5 on page 431

¹² <https://en.wikibooks.org/wiki/Haskell%2FThe%20Curry-Howard%20isomorphism>

Here, $f(n)$ yields well defined values for $n = 0$ and $n = 1$ but gives \perp for all other n .

The type `Integer -> Integer` has its \perp too, and it is defined with the help of the \perp from `Integer` this way:

$$\begin{aligned} \perp(n) &= \perp \\ &\text{for all} \\ &n \end{aligned}$$

where the \perp on the left hand side is of type `Integer -> Integer`, and the one right hand side is of type `Integer`.

To formalize, **partial functions** say, of type `Integer -> Integer` are at least mathematical mappings from the lifted integers $\mathbb{Z}_\perp = \{\perp, 0, \pm 1, \pm 2, \pm 3, \dots\}$ to the lifted integers. But this is not enough, since it does not acknowledge the special role of \perp . For example, the definition

$$g(n) = \begin{cases} 1 & \text{if } n \text{ is } \perp \\ \perp & \text{else} \end{cases}$$

is a function that turns infinite loops into terminating programs and vice versa, which is solving the halting problem. How can $g(\perp)$ yield a defined value when $g(1)$ is undefined? The intuition is that every partial function g should yield more defined answers for more defined arguments. To formalize, we can say that every concrete number is **more defined** than \perp :

$$\perp \sqsubset 1, \perp \sqsubset 2, \dots$$

Here, $a \sqsubset b$ denotes that b is more defined than a . Likewise, $a \sqsubseteq b$ will denote that either b is more defined than a or both are equal (and so have the same definedness). \sqsubseteq is also called the **semantic approximation order** because we can approximate defined values by less defined ones thus interpreting "more defined" as "approximating better". Of course, \perp is designed to be the least element of a data type, we always have that $\perp \sqsubseteq x$ for all x , except the case when x happens to denote \perp itself:

$$\forall x \neq \perp \quad \perp \sqsubseteq x$$

As no number is *more defined* than another, the mathematical relation \sqsubseteq is false for any pair of numbers:

$$1 \sqsubset 1$$

does not hold.

neither

$$1 \sqsubset 2$$

nor

$$2 \sqsubset 1$$

hold.

This is contrasted to ordinary order predicate \leq , which can compare any two numbers. A quick way to remember this is the sentence: "1 and 2 are different in terms of *information content* but are equal in terms of *information quantity*". That's another reason why we use a different symbol: \sqsubset .

neither

$$1 \sqsubseteq 2$$

nor

$$2 \sqsubseteq 1$$

hold,

but

$$1 \sqsubseteq 1$$

holds.

One says that \sqsubseteq specifies a **partial order** and that the values of type `Integer` form a **partially ordered set** (**poset** for short). A partial order is characterized by the following three laws

- *Reflexivity*, everything is just as defined as itself: $x \sqsubseteq x$ for all x
- *Transitivity*: if $x \sqsubseteq y$ and $y \sqsubseteq z$, then $x \sqsubseteq z$
- *Antisymmetry*: if both $x \sqsubseteq y$ and $y \sqsubseteq x$ hold, then x and y must be equal: $x = y$.

Exercises:

Do the integers form a poset with respect to the order \leq ?

We can depict the order \sqsubseteq on the values of type `Integer` by the following graph

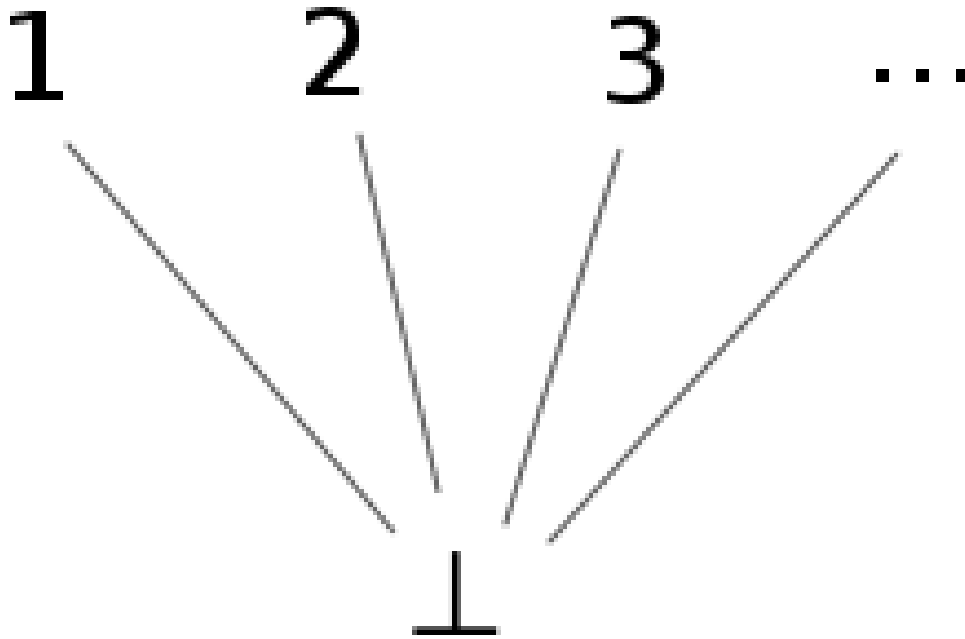

Figure 24

where every link between two nodes specifies that the one above is more defined than the one below. Because there is only one level (excluding \perp), one says that `Integer` is a *flat domain*. The picture also explains the name of \perp : it's called *bottom* because it always sits at the bottom.

58.2.3 Monotonicity

Our intuition about partial functions now can be formulated as following: every partial function f is a **monotone** mapping between partially ordered sets. More defined arguments will yield more defined values:

$$x \sqsubseteq y \Rightarrow f(x) \sqsubseteq f(y)$$

In particular, a monotone function h with $h(\perp) = 1$ is constant: $h(n) = 1$ for all n . Note that here it is crucial that $1 \sqsubseteq 2$ etc. don't hold.

Translated to Haskell, monotonicity means that we cannot use \perp as a condition, i.e. we cannot pattern match on \perp , or its equivalent `undefined`. Otherwise, the example g from above could be expressed as a Haskell program. As we shall see later, \perp also denotes non-terminating programs, so that the inability to observe \perp inside Haskell is related to the halting problem.

Of course, the notion of *more defined than* can be extended to partial functions by saying that a function is more defined than another if it is so at every possible argument:

$$f \sqsubseteq g \text{ if } \forall x. f(x) \sqsubseteq g(x)$$

Thus, the partial functions also form a poset, with the undefined function $\perp(x) = \perp$ being the least element.

58.3 Recursive Definitions as Fixed Point Iterations

58.3.1 Approximations of the Factorial Function

Now that we have the means to describe partial functions, we can give an interpretation to recursive definitions. Let's take the prominent example of the factorial function $f(n) = n!$ whose recursive definition is

$$f(n) = \text{if } n == 0 \text{ then } 1 \text{ else } n \cdot f(n-1)$$

Although we saw that interpreting this recursive function directly as a set description may lead to problems, we intuitively know that in order to calculate $f(n)$ for every given n we have to iterate the right hand side. This iteration can be formalized as follows: we calculate a sequence of functions f_k with the property that each one consists of the right hand side applied to the previous one, that is

$$f_{k+1}(n) = \text{if } n == 0 \text{ then } 1 \text{ else } n \cdot f_k(n-1)$$

We start with the undefined function $f_0(n) = \perp$, and the resulting sequence of partial functions reads:

$$f_1(n) = \begin{cases} 1 & \text{if } n \text{ is } 0 \\ \perp & \text{else} \end{cases}, f_2(n) = \begin{cases} 1 & \text{if } n \text{ is } 0 \\ 1 & \text{if } n \text{ is } 1 \\ \perp & \text{else} \end{cases}, f_3(n) = \begin{cases} 1 & \text{if } n \text{ is } 0 \\ 1 & \text{if } n \text{ is } 1 \\ 2 & \text{if } n \text{ is } 2 \\ \perp & \text{else} \end{cases}$$

and so on. Clearly,

$$\perp = f_0 \sqsubseteq f_1 \sqsubseteq f_2 \sqsubseteq \dots$$

and we expect that the sequence converges to the factorial function.

The iteration follows the well known scheme of a fixed point iteration

$$x_0, g(x_0), g(g(x_0)), g(g(g(x_0))), \dots$$

In our case, x_0 is a function and g is a *functional*, a mapping between functions. We have

$$x_0 = \perp$$

and

$$g(x) = n \mapsto \text{if } n == 0 \text{ then } 1 \text{ else } n * x(n-1)$$

If we start with $x_0 = \perp$, the iteration will yield increasingly defined approximations to the factorial function

$$\perp \sqsubseteq g(\perp) \sqsubseteq g(g(\perp)) \sqsubseteq g(g(g(\perp))) \sqsubseteq \dots$$

(Proof that the sequence increases: The first inequality $\perp \sqsubseteq g(\perp)$ follows from the fact that \perp is less defined than anything else. The second inequality follows from the first one by applying g to both sides and noting that g is monotone. The third follows from the second in the same fashion and so on.)

It is very illustrative to formulate this iteration scheme in Haskell. As functionals are just ordinary higher order functions, we have

```
g :: (Integer -> Integer) -> (Integer -> Integer)
g x = \n -> if n == 0 then 1 else n * x (n-1)

x0 :: Integer -> Integer
x0 = undefined

(f0:f1:f2:f3:f4:fs) = iterate g x0
```

We can now evaluate the functions f_0, f_1, \dots at sample arguments and see whether they yield `undefined` or not:

```
> f3 0
1
> f3 1
1
> f3 2
2
> f3 5
*** Exception: Prelude.undefined
> map f3 [0..]
[1,1,2,*** Exception: Prelude.undefined
> map f4 [0..]
[1,1,2,6,*** Exception: Prelude.undefined
> map f1 [0..]
[1,*** Exception: Prelude.undefined
```

Of course, we cannot use this to check whether `f4` is really undefined for all arguments.

58.3.2 Convergence

To the mathematician, the question whether this sequence of approximations converges is still to be answered. For that, we say that a poset is a **directed complete partial order (dcpo)** iff every monotone sequence $x_0 \sqsubseteq x_1 \sqsubseteq \dots$ (also called *chain*) has a least upper bound (supremum)

$$\sup_{\sqsubseteq} \{x_0 \sqsubseteq x_1 \sqsubseteq \dots\} = x$$

If that's the case for the semantic approximation order, we clearly can be sure that monotone sequence of functions approximating the factorial function indeed has a limit. For our denotational semantics, we will only meet dcpos which have a least element \perp which are called **complete partial orders (cpo)**.

The **Integers** clearly form a (d)cpo, because the monotone sequences consisting of more than one element must be of the form

$$\perp \sqsubseteq \dots \sqsubseteq \perp \sqsubseteq n \sqsubseteq n \sqsubseteq \dots \sqsubseteq n$$

where n is an ordinary number. Thus, n is already the least upper bound.

For functions **Integer** \rightarrow **Integer**, this argument fails because monotone sequences may be of infinite length. But because **Integer** is a (d)cpo, we know that for every point n , there is a least upper bound

$$\sup_{\sqsubseteq} \{\perp = f_0(n) \sqsubseteq f_1(n) \sqsubseteq f_2(n) \sqsubseteq \dots\} =: f(n)$$

As the semantic approximation order is defined point-wise, the function f is the supremum we looked for.

These have been the last touches for our aim to transform the impredicative definition of the factorial function into a well defined construction. Of course, it remains to be shown that $f(n)$ actually yields a defined value for every n , but this is not hard and far more reasonable than a completely ill-formed definition.

58.3.3 Bottom includes Non-Termination

It is instructive to try our newly gained insight into recursive definitions on an example that does not terminate:

$$f(n) = f(n+1)$$

The approximating sequence reads

$$f_0 = \perp, f_1 = \perp, \dots$$

and consists only of \perp . Clearly, the resulting limit is \perp again. From an operational point of view, a machine executing this program will loop indefinitely. We thus see that \perp may also denote a **non-terminating** function or value. Hence, given the halting problem, pattern matching on \perp in Haskell is impossible.

58.3.4 Interpretation as Least Fixed Point

Earlier, we called the approximating sequence an example of the well known "fixed point iteration" scheme. And of course, the definition of the factorial function f can also be thought as the specification of a fixed point of the functional g :

$$f = g(f) = n \mapsto \text{if } n == 0 \text{ then } 1 \text{ else } n \cdot f(n-1)$$

However, there might be multiple fixed points. For instance, there are several f which fulfill the specification

$$f = n \mapsto \text{if } n == 0 \text{ then } 1 \text{ else } f(n+1)$$

Of course, when executing such a program, the machine will loop forever on $f(1)$ or $f(2)$ and thus not produce any valuable information about the value of $f(1)$. This corresponds to choosing the *least defined* fixed point as semantic object f and this is indeed a canonical choice. Thus, we say that

$$f = g(f)$$

defines the **least fixed point** f of g . Clearly, *least* is with respect to our semantic approximation order \sqsubseteq .

The existence of a least fixed point is guaranteed by our iterative construction if we add the condition that g must be **continuous** (sometimes also called "chain continuous"). That simply means that g respects suprema of monotone sequences:

$$\sup_{\sqsubseteq} \{g(x_0) \sqsubseteq g(x_1) \sqsubseteq \dots\} = g\left(\sup_{\sqsubseteq} \{x_0 \sqsubseteq x_1 \sqsubseteq \dots\}\right)$$

We can then argue that with

$$f = \sup_{\sqsubseteq} \{x_0 \sqsubseteq g(x_0) \sqsubseteq g(g(x_0)) \sqsubseteq \dots\}$$

we have

$$\begin{aligned} g(f) &= g\left(\sup_{\sqsubseteq} \{x_0 \sqsubseteq g(x_0) \sqsubseteq g(g(x_0)) \sqsubseteq \dots\}\right) \\ &= \sup_{\sqsubseteq} \{g(x_0) \sqsubseteq g(g(x_0)) \sqsubseteq \dots\} \\ &= \sup_{\sqsubseteq} \{x_0 \sqsubseteq g(x_0) \sqsubseteq g(g(x_0)) \sqsubseteq \dots\} \\ &= f \end{aligned}$$

and the iteration limit is indeed a fixed point of g . You may also want to convince yourself that the fixed point iteration yields the *least* fixed point possible.

Exercises:

Prove that the fixed point obtained by fixed point iteration starting with $x_0 = \perp$ is also the least one, that it is smaller than any other fixed point. (Hint: \perp is the least element of our cpo and g is monotone)

By the way, how do we know that each Haskell function we write down indeed is continuous? Just as with monotonicity, this has to be enforced by the programming language. Admittedly, these properties can somewhat be enforced or broken at will, so the question feels a bit void. But intuitively, monotonicity is guaranteed by not allowing pattern matches on \perp . For continuity, we note that for an arbitrary type \mathbf{a} , every simple function $\mathbf{a} \rightarrow \mathbf{Integer}$ is automatically continuous because the monotone sequences of $\mathbf{Integer}$ s are of finite length. Any infinite chain of values of type \mathbf{a} gets mapped to a finite chain of $\mathbf{Integer}$ s and respect for suprema becomes a consequence of monotonicity. Thus, all functions of the special case $\mathbf{Integer} \rightarrow \mathbf{Integer}$ must be continuous. For functionals like $g :: (\mathbf{Integer} \rightarrow \mathbf{Integer}) \rightarrow (\mathbf{Integer} \rightarrow \mathbf{Integer})$, the continuity then materializes due to currying, as the type is isomorphic to $::((\mathbf{Integer} \rightarrow \mathbf{Integer}), \mathbf{Integer}) \rightarrow \mathbf{Integer}$ and we can take $\mathbf{a} = ((\mathbf{Integer} \rightarrow \mathbf{Integer}), \mathbf{Integer})$.

In Haskell, the fixed interpretation of the factorial function can be coded as

```
factorial = fix g
```

with the help of the fixed point combinator

```
fix :: (a -> a) -> a.
```

We can define it by

```
fix f = let x = f x in x
```

which leaves us somewhat puzzled because when expanding *factorial*, the result is not anything different from how we would have defined the factorial function in Haskell in the first place. But of course, the construction this whole section was about is not at all present when running a real Haskell program. It's just a means to put the mathematical

interpretation of Haskell programs on a firm ground. Yet it is very nice that we can explore these semantics in Haskell itself with the help of `undefined`.

58.4 Strict and Non-Strict Semantics

After having elaborated on the denotational semantics of Haskell programs, we will drop the mathematical function notation $f(n)$ for semantic objects in favor of their now equivalent Haskell notation `f n`.

58.4.1 Strict Functions

A function `f` with one argument is called **strict**, if and only if

$$f \perp = \perp.$$

Here are some examples of strict functions

```
id    x = x
succ  x = x + 1
power2 0 = 1
power2 n = 2 * power2 (n-1)
```

and there is nothing unexpected about them. But why are they strict? It is instructive to prove that these functions are indeed strict. For `id`, this follows from the definition. For `succ`, we have to ponder whether $\perp + 1$ is \perp or not. If it was not, then we should for example have $\perp + 1 = 2$ or more general $\perp + 1 = k$ for some concrete number k . We remember that every function is *monotone*, so we should have for example

$$2 = \perp + 1 \sqsubseteq 4 + 1 = 5$$

as $\perp \sqsubseteq 4$. But neither of $2 \sqsubseteq 5$, $2 = 5$ nor $2 \supseteq 5$ is valid so that k cannot be 2. In general, we obtain the contradiction

$$k = \perp + 1 \sqsubseteq k + 1 = k + 1.$$

and thus the only possible choice is

$$\text{succ } \perp = \perp + 1 = \perp$$

and `succ` is strict.

Exercises:

Prove that `power2` is strict. While one can base the proof on the "obvious" fact that `power2 n` is 2^n , the latter is preferably proven using fixed point iteration.

58.4.2 Non-Strict and Strict Languages

Searching for **non-strict** functions, it happens that there is only one prototype of a non-strict function of type `Integer -> Integer`:

```
one x = 1
```

Its variants are `constk x = k` for every concrete number k . Why are these the only ones possible? Remember that `one n` can be no less defined than `one ⊥`. As `Integer` is a flat domain, both must be equal.

Why is `one` non-strict? To see that it is, we use a Haskell interpreter and try

```
> one (undefined :: Integer)
1
```

which is not \perp . This is reasonable as `one` completely ignores its argument. When interpreting \perp in an operational sense as "non-termination", one may say that the non-strictness of `one` means that it does not force its argument to be evaluated and therefore avoids the infinite loop when evaluating the argument \perp . But one might as well say that every function must evaluate its arguments before computing the result which means that `one ⊥` should be \perp , too. That is, if the program computing the argument does not halt, `one` should not halt as well.¹³ It shows up that one can *choose freely* this or the other design for a functional programming language. One says that the language is *strict* or *non-strict* depending on whether functions are strict or non-strict by default. The choice for Haskell is non-strict. In contrast, the functional languages ML and Lisp choose strict semantics.

58.4.3 Functions with several Arguments

The notion of strictness extends to functions with several variables. For example, a function `f` of two arguments is *strict in the second argument* if and only if

$$f\ x\ \perp = \perp$$

for every `x`. But for multiple arguments, mixed forms where the strictness depends on the given value of the other arguments, are much more common. An example is the conditional

```
cond b x y = if b then x else y
```

We see that it is strict in `y` depending on whether the test `b` is `True` or `False`:

```
cond True  x ⊥ = x
cond False x ⊥ = ⊥
```

and likewise for `x`. Apparently, `cond` is certainly \perp if both `x` and `y` are, but not necessarily when at least one of them is defined. This behavior is called **joint strictness**.

Clearly, `cond` behaves like the if-then-else statement where it is crucial not to evaluate both the `then` and the `else` branches:

¹³ Strictness as premature evaluation of function arguments is elaborated in the chapter Graph Reduction [^]{Chapter65 on page 487}.

```

if null xs then 'a' else head xs
if n == 0 then 1 else 5 / n

```

Here, the else part is \perp when the condition is met. Thus, in a non-strict language, we have the possibility to wrap primitive control statements such as if-then-else into functions like `cond`. This way, we can define our own control operators. In a strict language, this is not possible as both branches will be evaluated when calling `cond` which makes it rather useless. This is a glimpse of the general observation that non-strictness offers more flexibility for code reuse than strictness. See the chapter Laziness¹⁴¹⁵ for more on this subject.

58.5 Algebraic Data Types

After treating the motivation case of partial functions between `Integers`, we now want to extend the scope of denotational semantics to arbitrary algebraic data types in Haskell.

A word about nomenclature: the collection of semantic objects for a particular type is usually called a **domain**. This term is more a generic name than a particular definition and we decide that our domains are cpos (complete partial orders), that is sets of values together with a relation *more defined* that obeys some conditions to allow fixed point iteration. Usually, one adds additional conditions to the cpos that ensure that the values of our domains can be represented in some finite way on a computer and thereby avoiding to ponder the twisted ways of uncountable infinite sets. But as we are not going to prove general domain theoretic theorems, the conditions will just happen to hold by construction.

58.5.1 Constructors

Let's take the example types

```

data Bool    = True | False
data Maybe a = Just a | Nothing

```

Here, `True`, `False` and `Nothing` are nullary constructors whereas `Just` is a unary constructor. The inhabitants of `Bool` form the following domain:

¹⁴ Chapter 66 on page 499

¹⁵ The term *Laziness* comes from the fact that the prevalent implementation technique for non-strict languages is called *lazy evaluation*

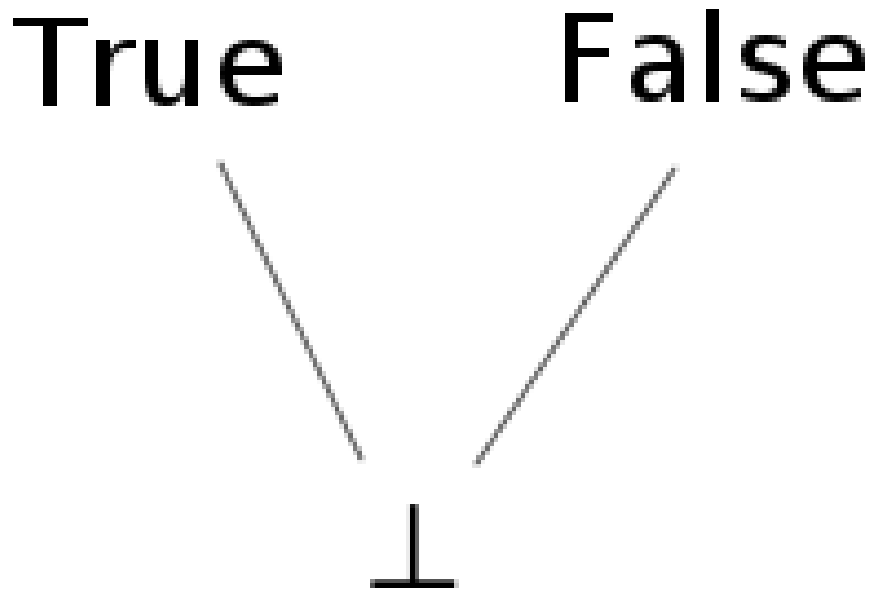

Figure 25

Remember that \perp is added as least element to the set of values `True` and `False`, we say that the type is **lifted**¹⁶. A domain whose poset diagram consists of only one level is called a **flat domain**. We already know that *Integer* is a flat domain as well, it's just that the level above \perp has an infinite number of elements.

What are the possible inhabitants of `Maybe Bool`? They are

\perp , <code>Nothing</code> , <code>Just ⊥</code> , <code>Just True</code> , <code>Just False</code>

So the general rule is to insert all possible values into the unary (binary, ternary, ...) constructors as usual but without forgetting \perp . Concerning the partial order, we remember the condition that the constructors should be monotone just as any other functions. Hence, the partial order looks as follows

¹⁶ The term *lifted* is somewhat overloaded, see also `Unboxed Types` ^{Chapter58.1.2 on page 419}.

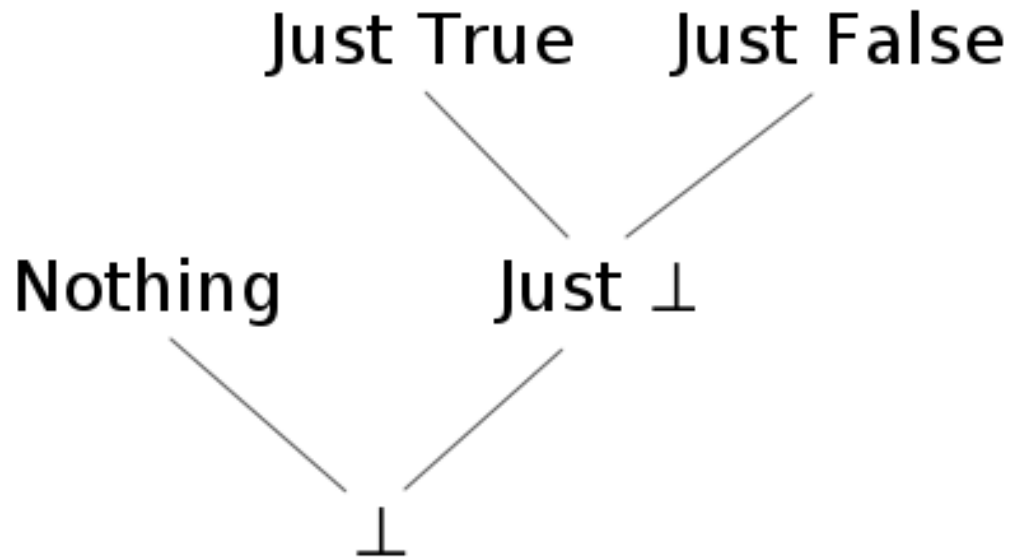

Figure 26

But there is something to ponder: why isn't `Just ⊥ = ⊥`? I mean "Just undefined" is as undefined as "undefined"! The answer is that this depends on whether the language is strict or non-strict. In a strict language, all constructors are strict by default, i.e. `Just ⊥ = ⊥` and the diagram would reduce to

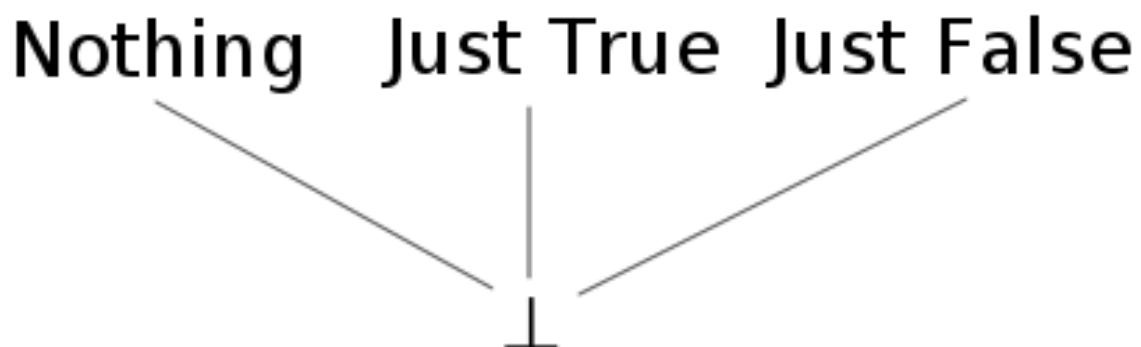

Figure 27

As a consequence, all domains of a strict language are flat.

But in a non-strict language like Haskell, constructors are non-strict by default and `Just ⊥` is a new element different from `⊥`, because we can write a function that reacts differently to them:

```

f (Just _) = 4
f Nothing  = 7
  
```

As `f` ignores the contents of the `Just` constructor, `f (Just ⊥)` is `4` but `f ⊥` is `⊥` (intuitively, if `f` is passed `⊥`, it will not be possible to tell whether to take the `Just` branch or the `Nothing` branch, and so `⊥` will be returned).

This gives rise to **non-flat domains** as depicted in the former graph. What should these be of use for? In the context of Graph Reduction¹⁷, we may also think of `⊥` as an unevaluated expression. Thus, a value `x = Just ⊥` may tell us that a computation (say a lookup) succeeded and is not `Nothing`, but that the true value has not been evaluated yet. If we are only interested in whether `x` succeeded or not, this actually saves us from the unnecessary work to calculate whether `x` is `Just True` or `Just False` as would be the case in a flat domain. The full impact of non-flat domains will be explored in the chapter Laziness¹⁸, but one prominent example are infinite lists treated in section Recursive Data Types and Infinite Lists¹⁹.

58.5.2 Pattern Matching

In the section Strict Functions²⁰, we proved that some functions are strict by inspecting their results on different inputs and insisting on monotonicity. However, in the light of algebraic data types, there can only be one source of strictness in real life Haskell: pattern matching, i.e. `case` expressions. The general rule is that pattern matching on a constructor of a `data`-type will force the function to be strict, i.e. matching `⊥` against a constructor always gives `⊥`. For illustration, consider

```
const1 _ = 1
```

```
const1' True  = 1
const1' False = 1
```

The first function `const1` is non-strict whereas the `const1'` is strict because it decides whether the argument is `True` or `False` although its result doesn't depend on that. Pattern matching in function arguments is equivalent to `case`-expressions

```
const1' x = case x of
  True  -> 1
  False -> 1
```

which similarly impose strictness on `x`: if the argument to the `case` expression denotes `⊥` the whole `case` will denote `⊥`, too. However, the argument for `case` expressions may be more involved as in

```
foo k table = case lookup ("Foo." ++ k) table of
  Nothing -> ...
  Just x   -> ...
```

17 Chapter 65 on page 487

18 Chapter 66 on page 499

19 Chapter 58.5.3 on page 436

20 Chapter 58.4.1 on page 429

and it can be difficult to track what this means for the strictness of `foo`.

An example for multiple pattern matches in the equational style is the logical or:

```
or True _ = True
or _ True = True
or _ _    = False
```

Note that equations are matched from top to bottom. The first equation for `or` matches the first argument against `True`, so `or` is strict in its first argument. The same equation also tells us that `or True x` is non-strict in `x`. If the first argument is `False`, then the second will be matched against `True` and `or False x` is strict in `x`. Note that while wildcards are a general sign of non-strictness, this depends on their position with respect to the pattern matches against constructors.

Exercises:

1. Give an equivalent discussion for the logical `and`
2. Can the logical "excluded or" (`xor`) be non-strict in one of its arguments if we know the other?

There is another form of pattern matching, namely **irrefutable patterns** marked with a tilde `~`. Their use is demonstrated by

```
f ~(Just x) = 1
f Nothing   = 2
```

An irrefutable pattern always succeeds (hence the name) resulting in `f ⊥ = 1`. But when changing the definition of `f` to

```
f ~(Just x) = x + 1
f Nothing   = 2    -- this line may as well be left away
```

we have

```
f ⊥          = ⊥ + 1 = ⊥
f (Just 1)   = 1 + 1 = 2
```

If the argument matches the pattern, `x` will be bound to the corresponding value. Otherwise, any variable like `x` will be bound to `⊥`.

By default, `let` and `where` bindings are non-strict, too:

```
foo key map = let Just x = lookup key map in ...
```

is equivalent to

```
foo key map = case (lookup key map) of ~(Just x) -> ...
```

Exercises:

1. The Haskell language definition^a gives the detailed semantics of pattern matching^b and you should now be able to understand it. So go on and have a look!
2. Consider a function `or` of two Boolean arguments with the following properties:

```
or ⊥   ⊥   = ⊥
or True ⊥   = True
or ⊥   True = True

or False y   = y
or x False   = x
```

This function is another example of joint strictness, but a much sharper one: the result is only `⊥` if both arguments are (at least when we restrict the arguments to `True` and `⊥`). Can such a function be implemented in Haskell?

^a <http://www.haskell.org/onlinereport/>

^b <http://www.haskell.org/onlinereport/exps.html#case-semantic>

58.5.3 Recursive Data Types and Infinite Lists

The case of recursive data structures is not very different from the base case. Consider a list of unit values

```
data List = [] | () : List
```

Though this seems like a simple type, there is a surprisingly complicated number of ways you can fit `⊥` in here and there, and therefore the corresponding graph is complicated. The bottom of this graph is shown below. An ellipsis indicates that the graph continues along this direction. A red ellipse behind an element indicates that this is the end of a chain; the element is in normal form.

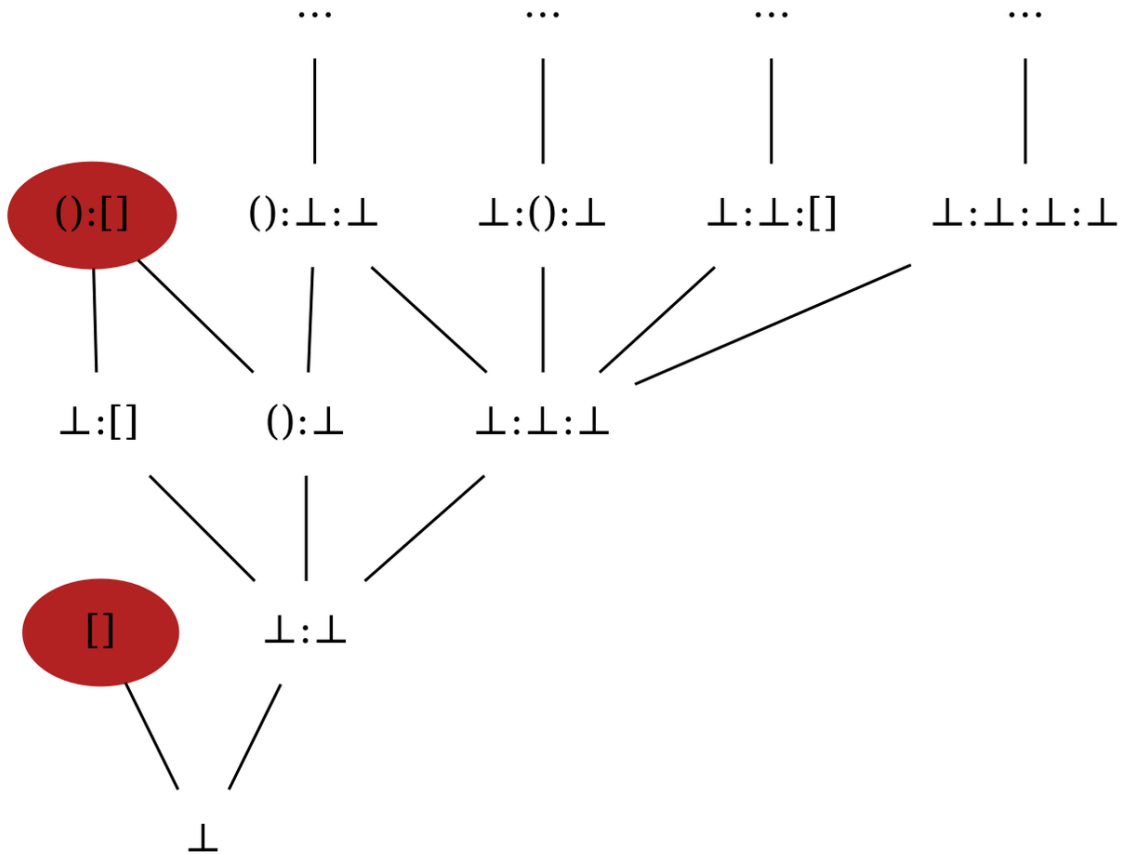

Figure 28

and so on. But now, there are also chains of infinite length like

$$\perp \sqsubseteq ():\perp \sqsubseteq ():():\perp \sqsubseteq \dots$$

This causes us some trouble as we noted in section Convergence²¹ that every monotone sequence must have a least upper bound. This is only possible if we allow for **infinite lists**. Infinite lists (sometimes also called *streams*) turn out to be very useful and their manifold use cases are treated in full detail in chapter Laziness²². Here, we will show what their denotational semantics should be and how to reason about them. Note that while the following discussion is restricted to lists only, it easily generalizes to arbitrary recursive data structures like trees.

In the following, we will switch back to the standard list type

```
data [a] = [] | a : [a]
```

²¹ Chapter 58.3.2 on page 426

²² Chapter 66 on page 499

to close the syntactic gap to practical programming with infinite lists in Haskell.

Exercises:

1. Draw the non-flat domain corresponding `[Bool]`.
2. How is the graphic to be changed for `[Integer]`?

Calculating with infinite lists is best shown by example. For that, we need an infinite list

```
ones :: [Integer]
ones = 1 : ones
```

When applying the fixed point iteration to this recursive definition, we see that `ones` ought to be the supremum of

$$\perp \sqsubseteq 1:\perp \sqsubseteq 1:1:\perp \sqsubseteq 1:1:1:\perp \sqsubseteq \dots,$$

that is an infinite list of 1. Let's try to understand what `take 2 ones` should be. With the definition of `take`

```
take 0 _      = []
take n (x:xs) = x : take (n-1) xs
take n []     = []
```

we can apply `take` to elements of the approximating sequence of `ones`:

```
take 2 \perp      ==> \perp
take 2 (1:\perp)  ==> 1 : take 1 \perp      ==> 1 : \perp
take 2 (1:1:\perp) ==> 1 : take 1 (1:\perp) ==> 1 : 1 : take 0 \perp
                    ==> 1 : 1 : []
```

We see that `take 2 (1:1:1:\perp)` and so on must be the same as `take 2 (1:1:\perp) = 1:1:[]` because `1:1:[]` is fully defined. Taking the supremum on both the sequence of input lists and the resulting sequence of output lists, we can conclude

```
take 2 ones = 1:1:[]
```

Thus, taking the first two elements of `ones` behaves exactly as expected.

Generalizing from the example, we see that reasoning about infinite lists involves considering the approximating sequence and passing to the supremum, the truly infinite list. Still, we did not give it a firm ground. The solution is to identify the infinite list with the whole chain itself and to formally add it as a new element to our domain: the infinite list *is* the sequence of its approximations. Of course, any infinite list like `ones` can be compactly depicted as

```
ones = 1 : 1 : 1 : 1 : ...
```

what simply means that

```
ones = (⊥ ⊆ 1:⊥ ⊆ 1:1:⊥ ⊆ ...)
```

Exercises:

- Of course, there are more interesting infinite lists than `ones`. Can you write recursive definition in Haskell for
 - the natural numbers `nats = 1:2:3:4:...`
 - a cycle like `cycle123 = 1:2:3: 1:2:3 : ...`
- Look at the Prelude functions `repeat` and `iterate` and try to solve the previous exercise with their help.
- Use the example from the text to find the value the expression `drop 3 nats` denotes.
- Assume that the work in a strict setting, i.e. that the domain of `[Integer]` is flat. What does the domain look like? What about infinite lists? What value does `ones` denote?

What about the puzzle of how a computer can calculate with infinite lists? It takes an infinite amount of time, after all? Well, this is true. But the trick is that the computer may well finish in a finite amount of time if it only considers a finite part of the infinite list. So, infinite lists should be thought of as *potentially* infinite lists. In general, intermediate results take the form of infinite lists whereas the final value is finite. It is one of the benefits of denotational semantics that one can treat the intermediate infinite data structures as truly infinite when reasoning about program correctness.

Exercises:

- To demonstrate the use of infinite lists as intermediate results, show that `take 3 (map (+1) nats) = take 3 (tail nats)` by first calculating the infinite sequence corresponding to `map (+1) nats`.
- Of course, we should give an example where the final result indeed takes an infinite time. So, what does

```
filter (< 5) nats
```

denote?

- Sometimes, one can replace `filter` with `takeWhile` in the previous exercise. Why only sometimes and what happens if one does?

As a last note, the construction of a recursive domain can be done by a fixed point iteration similar to recursive definition for functions. Yet, the problem of infinite chains has to be tackled explicitly. See the literature in External Links²³ for a formal construction.

²³ Chapter 58.7 on page 443

58.5.4 Haskell specialities: Strictness Annotations and Newtypes

Haskell offers a way to change the default non-strict behavior of data type constructors by *strictness annotations*. In a data declaration like

```
data Maybe' a = Just' !a | Nothing'
```

an exclamation point `!` before an argument of the constructor specifies that it should be strict in this argument. Hence we have `Just' ⊥ = ⊥` in our example. Further information may be found in chapter *Strictness*²⁴.

In some cases, one wants to rename a data type, like in

```
data Couldbe a = Couldbe (Maybe a)
```

However, `Couldbe a` contains both the elements `⊥` and `Couldbe ⊥`. With the help of a *newtype* definition

```
newtype Couldbe a = Couldbe (Maybe a)
```

we can arrange that `Couldbe a` is semantically equal to `Maybe a`, but different during type checking. In particular, the constructor `Couldbe` is strict. Yet, this definition is subtly different from

```
data Couldbe' a = Couldbe' !(Maybe a)
```

To explain how, consider the functions

```
f (Couldbe m) = 42
f' (Couldbe' m) = 42
```

Here, `f' ⊥` will cause the pattern match on the constructor `Couldbe'` to fail with the effect that `f' ⊥ = ⊥`. But for the newtype, the match on `Couldbe` will never fail, we get `f ⊥ = 42`. In a sense, the difference can be stated as:

- for the strict case, `Couldbe' ⊥` is a synonym for `⊥`
- for the newtype, `⊥` is a synonym for `Couldbe ⊥`

with the agreement that a pattern match on `⊥` fails and that a match on *Constructor* `⊥` does not.

Newtypes may also be used to define recursive types. An example is the alternate definition of the list type `[a]`

²⁴ Chapter 67 on page 511

```
newtype List a = In (Maybe (a, List a))
```

Again, the point is that the constructor `In` does not introduce an additional lifting with \perp .

Here are a few more examples to differentiate between `newtype` and non-strict and strict `data` declarations (in the interactive prompt):

```
Prelude> data D = D Int
Prelude> data SD = SD !Int
Prelude> newtype NT = NT Int
Prelude> (\(D _) -> 42) (D undefined)
42
Prelude> (\(SD _) -> 42) (SD undefined)
*** Exception: Prelude.undefined
[...]
Prelude> (\(NT _) -> 42) (NT undefined)
42
Prelude> (\(D _) -> 42) undefined
*** Exception: Prelude.undefined
[...]
Prelude> (\(SD _) -> 42) undefined
*** Exception: Prelude.undefined
[...]
Prelude> (\(NT _) -> 42) undefined
42
```

58.6 Other Selected Topics

58.6.1 Abstract Interpretation and Strictness Analysis

As lazy evaluation means a constant computational overhead, a Haskell compiler may want to discover where inherent non-strictness is not needed at all which allows it to drop the overhead at these particular places. To that extent, the compiler performs **strictness analysis** just like we proved in some functions to be strict section `Strict Functions`²⁵. Of course, details of strictness depending on the exact values of arguments like in our example `cond` are out of scope (this is in general undecidable). But the compiler may try to find approximate strictness information and this works in many common cases like `power2`.

Now, **abstract interpretation** is a formidable idea to reason about strictness: ...

For more about strictness analysis, see the research papers about strictness analysis on the Haskell wiki²⁶.

58.6.2 Interpretation as Powersets

So far, we have introduced \perp and the semantic approximation order \sqsubseteq abstractly by specifying their properties. However, both as well as any inhabitants of a data type like `Just` \perp can be interpreted as ordinary sets. This is called the **powerset construction**. NOTE: *i'm not sure whether this is really true. Someone how knows, please correct this.*

²⁵ Chapter 58.4.1 on page 429

²⁶ http://haskell.org/haskellwiki/Research_papers/Compilation#Strictness

The idea is to think of \perp as the *set of all possible values* and that a computation retrieves more information this by choosing a subset. In a sense, the denotation of a value starts its life as the set of all values which will be reduced by computations until there remains a set with a single element only.

As an example, consider `Bool` where the domain looks like



The values `True` and `False` are encoded as the singleton sets `{True}` and `{False}` and \perp is the set of all possible values.

Another example is `Maybe Bool`:



We see that the semantic approximation order is equivalent to set inclusion, but with arguments switched:

$$x \sqsubseteq y \iff x \supseteq y$$

This approach can be used to give a semantics to exceptions in Haskell²⁷.

58.6.3 Naïve Sets are unsuited for Recursive Data Types

In the section *What to choose as Semantic Domain?*²⁸, we argued that taking simple sets as denotation for types doesn't work well with partial functions. In the light of recursive data types, things become even worse as John C. Reynolds showed in his paper *Polymorphism is not set-theoretic*²⁹.

Reynolds actually considers the recursive type

```
newtype U = In ((U -> Bool) -> Bool)
```

²⁷ S. Peyton Jones, A. Reid, T. Hoare, S. Marlow, and F. Henderson. A semantics for imprecise exceptions. <http://research.microsoft.com/~simonpj/Papers/imprecise-exn.htm> In Programming Languages Design and Implementation. ACM press, May 1999.

²⁸ Chapter 58.1.2 on page 419

²⁹ John C. Reynolds. *Polymorphism is not set-theoretic*. INRIA Rappports de Recherche No. 296. May 1984.

Interpreting `Bool` as the set `{True, False}` and the function type `A -> B` as the set of functions from `A` to `B`, the type `U` cannot denote a set. This is because `(A -> Bool)` is the set of subsets (powerset) of `A` which, due to a diagonal argument analogous to Cantor's argument that there are "more" real numbers than natural ones, always has a bigger cardinality than `A`. Thus, `(U -> Bool) -> Bool` has an even bigger cardinality than `U` and there is no way for it to be isomorphic to `U`. Hence, the set `U` must not exist, a contradiction.

In our world of partial functions, this argument fails. Here, an element of `U` is given by a sequence of approximations taken from the sequence of domains

`⊥`, `(⊥ -> Bool) -> Bool`, `((⊥ -> Bool) -> Bool) -> Bool` and so on

where `⊥` denotes the domain with the single inhabitant `⊥`. While the author of this text admittedly has no clue on what such a thing should mean, the constructor gives a perfectly well defined object for `U`. We see that the type `(U -> Bool) -> Bool` merely consists of shifted approximating sequences which means that it is isomorphic to `U`.

As a last note, Reynolds actually constructs an equivalent of `U` in the second order polymorphic lambda calculus. There, it happens that all terms have a normal form, i.e. there are only total functions when we do not include a primitive recursion operator `fix :: (a -> a) -> a`. Thus, there is no true need for partial functions and `⊥`, yet a naïve set theoretic semantics fails. We can only speculate that this has to do with the fact that not every mathematical function is computable. In particular, the set of computable functions `Nat -> Bool` should not have a bigger cardinality than `Nat`.

58.7 External Links

w:Denotational semantics³⁰

Online books about Denotational Semantics

- Denotational Semantics. A Methodology for Language Development . Allyn and Bacon , , 1986

³⁰ <https://en.wikipedia.org/wiki/Denotational%20semantics>

59 Category theory

This article attempts to give an overview of category theory, in so far as it applies to Haskell. To this end, Haskell code will be given alongside the mathematical definitions. Absolute rigour is not followed; in its place, we seek to give the reader an intuitive feel for what the concepts of category theory are and how they relate to Haskell.

59.1 Introduction to categories

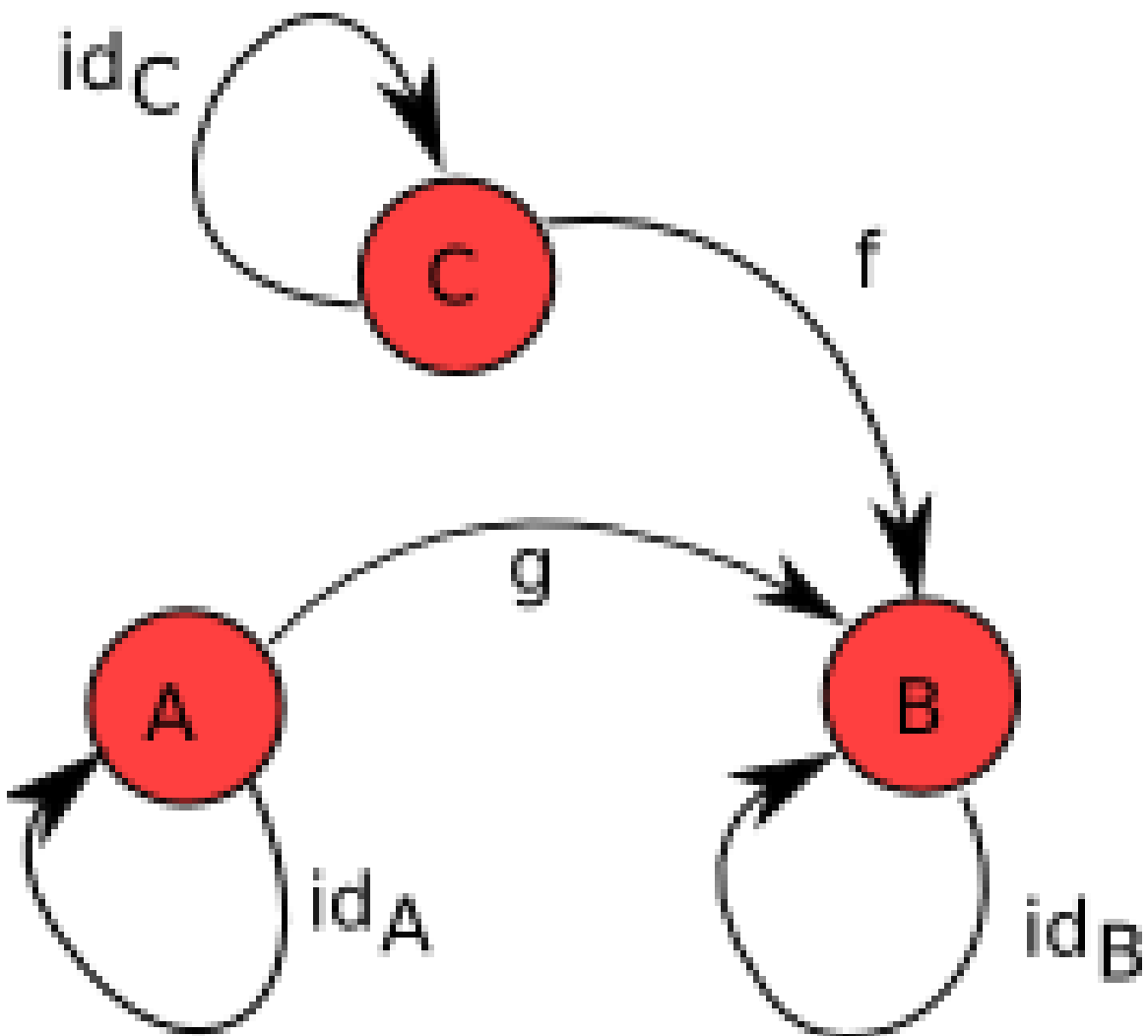

Figure 29 A simple category, with three objects A , B and C , three identity morphisms id_A , id_B and id_C , and two other morphisms $f : C \rightarrow B$ and $g : A \rightarrow B$. The third element (the specification of how to compose the morphisms) is not shown.

A category is, in essence, a simple collection. It has three components:

- A collection of **objects**.
- A collection of **morphisms**, each of which ties two objects (a *source object* and a *target object*) together. (These are sometimes called **arrows**, but we avoid that term here as it has other connotations in Haskell.) If f is a morphism with source object A and target object B , we write $f : A \rightarrow B$.
- A notion of **composition** of these morphisms. If $g : A \rightarrow B$ and $f : B \rightarrow C$ are two morphisms, they can be composed, resulting in a morphism $f \circ g : A \rightarrow C$.

Lots of things form categories. For example, **Set** is the category of all sets with morphisms as standard functions and composition being standard function composition. (Category names are often typeset in bold face.) **Grp** is the category of all groups with morphisms as functions that preserve group operations (the group homomorphisms), i.e. for any two groups, G with operation $*$ and H with operation \cdot , a function $f : G \rightarrow H$ is a morphism in **Grp** if:

$$f(u * v) = f(u) \cdot f(v)$$

It may seem that morphisms are always functions, but this needn't be the case. For example, any partial order (P, \leq) defines a category where the objects are the elements of P , and there is a morphism between any two objects A and B iff $A \leq B$. Moreover, there are allowed to be multiple morphisms with the same source and target objects; using the **Set** example, \sin and \cos are both functions with source object \mathbb{R} (the set of real numbers) and target object $[-1, 1]$, but they're most certainly not the same morphism!

59.1.1 Category laws

There are three laws that categories need to follow. Firstly, and most simply, the composition of morphisms needs to be *associative*. Symbolically,

$$f \circ (g \circ h) = (f \circ g) \circ h$$

Morphisms are applied right to left in Haskell and most commonly in mathematics, so with $f \circ g$ first g is applied, then f .

Secondly, the category needs to be *closed* under the composition operation. So if $f : B \rightarrow C$ and $g : A \rightarrow B$, then there must be some morphism $h : A \rightarrow C$ in the category such that $h = f \circ g$. We can see how this works using the following category:

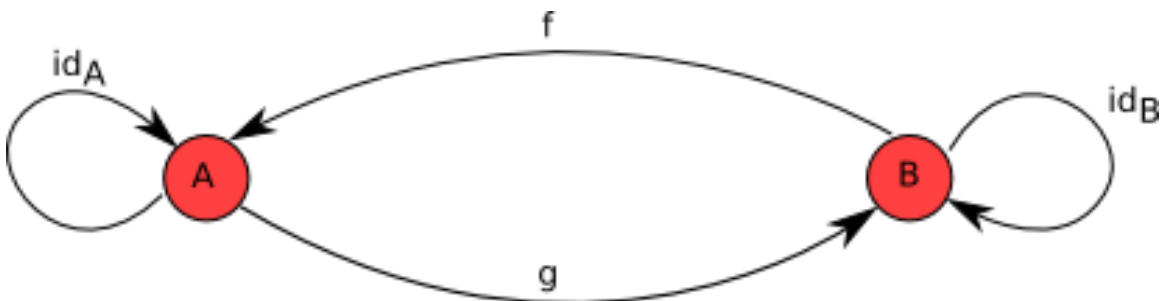

Figure 30

f and g are both morphisms so we must be able to compose them and get another morphism in the category. So which is the morphism $f \circ g$? The only option is id_A . Similarly, we see that $g \circ f = \text{id}_B$.

Lastly, given a category C there needs to be for every object A an *identity morphism*, $\text{id}_A : A \rightarrow A$ that is an identity of composition with other morphisms. Put precisely, for every morphism $g : A \rightarrow B$:

$$g \circ \text{id}_A = \text{id}_B \circ g = g$$

Note that expressions involving the composition operation (\circ) can be equal to each other, but individual morphisms can never equal each other. For example, if there is two morphisms from object A to object B , namely $f : A \rightarrow B$ and $g : A \rightarrow B$, then it is never true that $f = g$.

59.1.2 **Hask**, the Haskell category

The main category we'll be concerning ourselves with in this article is **Hask**, which treats Haskell types as objects and Haskell functions as morphisms and uses $(.)$ for composition: a function $f :: A \rightarrow B$ for types A and B is a morphism in **Hask**. We can check the first and second law easily: we know $(.)$ is an associative function, and clearly, for any f and g , $f \circ g$ is another function. In **Hask**, the identity morphism is id , and we have trivially:

$$\text{id} \circ f = f \circ \text{id} = f$$

¹ This isn't an exact translation of the law above, though; we're missing subscripts. The function id in Haskell is *polymorphic*—it can take many different types for its domain and range, or, in category-speak, can have many different source and target objects. But morphisms in category theory are by definition *monomorphic*—each morphism has one specific source object and one specific target object (note for experts: *monomorphic* here is not being used in the category theoretic sense). A polymorphic Haskell function can be made monomorphic by specifying its type (*instantiating* with a monomorphic type), so it would be more precise if we said that the identity morphism from **Hask** on a type A is $(\text{id} :: A \rightarrow A)$. With this in mind, the above law would be rewritten as:

$$(\text{id} :: B \rightarrow B) \circ f = f \circ (\text{id} :: A \rightarrow A) = f$$

However, for simplicity, we will ignore this distinction when the meaning is clear.

¹ Actually, there is a subtlety here: because $(.)$ is a lazy function, if f is `undefined`, we have that $\text{id} \circ f = \backslash_ \rightarrow \perp$. Now, while this may seem equivalent to \perp for all intents and purposes, you can actually tell them apart using the strictifying function `seq`, meaning that the last category law is broken. We can define a new strict composition function, $f \circ! g = ((.) \$! f) \$! g$, that makes **Hask** a category. We proceed by using the normal $(.)$, though, and attribute any discrepancies to the fact that `seq` breaks an awful lot of the nice language properties anyway.

Exercises:

- As was mentioned, any partial order (P, \leq) is a category with objects as the elements of P and a morphism between elements a and b iff $a \leq b$. Which of the above laws guarantees the transitivity of \leq ?
- (Harder.) If we add another morphism to the above example, as illustrated below, it fails to be a category. Why? Hint: think about associativity of the composition operation.

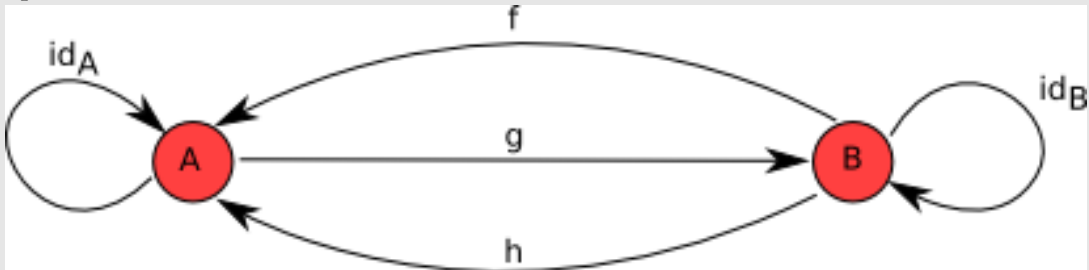

Figure 31

59.2 Functors

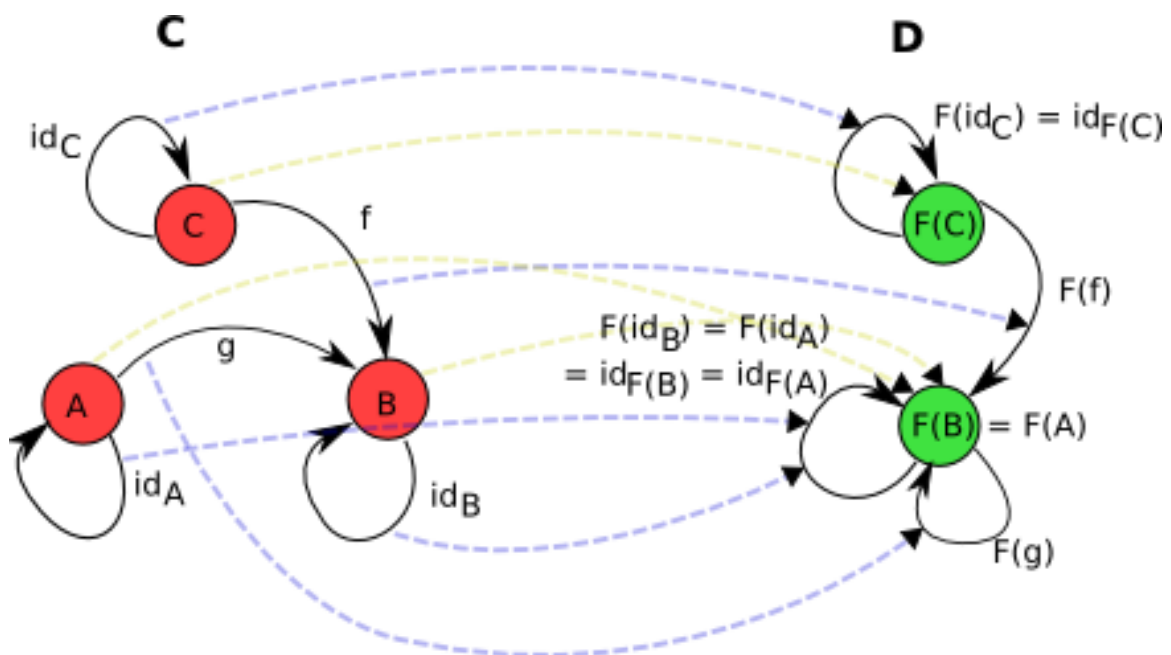

Figure 32 A functor between two categories, **C** and **D**. Of note is that the objects A and B both get mapped to the same object in **D**, and that therefore g becomes a morphism with the same source and target object (but isn't necessarily an identity), and id_A and id_B become the same morphism. The arrows showing the mapping of objects are shown in a dotted, pale olive. The arrows showing the mapping of morphisms are shown in a dotted, pale blue.

So we have some categories which have objects and morphisms that relate our objects together. The next Big Topic in category theory is the **functor**, which relates categories together. A functor is essentially a transformation between categories, so given categories C and D , a functor $F : C \rightarrow D$:

- Maps any object A in C to $F(A)$, in D .
- Maps morphisms $f : A \rightarrow B$ in C to $F(f) : F(A) \rightarrow F(B)$ in D .

One of the canonical examples of a functor is the forgetful functor $\mathbf{Grp} \rightarrow \mathbf{Set}$ which maps groups to their underlying sets and group morphisms to the functions which behave the same but are defined on sets instead of groups. Another example is the power set functor $\mathbf{Set} \rightarrow \mathbf{Set}$ which maps sets to their power sets and maps functions $f : X \rightarrow Y$ to functions $\mathcal{P}(X) \rightarrow \mathcal{P}(Y)$ which take inputs $U \subseteq X$ and return $f(U)$, the image of U under f , defined by $f(U) = \{f(u) : u \in U\}$. For any category C , we can define a functor known as the identity functor on C , or $1_C : C \rightarrow C$, that just maps objects to themselves and morphisms to themselves. This will turn out to be useful in the monad laws² section later on.

Once again there are a few axioms that functors have to obey. Firstly, given an identity morphism id_A on an object A , $F(\text{id}_A)$ must be the identity morphism on $F(A)$, i.e.:

$$F(\text{id}_A) = \text{id}_{F(A)}$$

Secondly functors must distribute over morphism composition, i.e.

$$F(f \circ g) = F(f) \circ F(g)$$

Exercises:

For the diagram given on the right, check these functor laws.

59.2.1 Functors on Hask

The Functor typeclass you have probably seen in Haskell does in fact tie in with the categorical notion of a functor. Remember that a functor has two parts: it maps objects in one category to objects in another and morphisms in the first category to morphisms in the second. Functors in Haskell are from \mathbf{Hask} to $func$, where $func$ is the subcategory of \mathbf{Hask} defined on just that functor's types. E.g. the list functor goes from \mathbf{Hask} to \mathbf{Lst} , where \mathbf{Lst} is the category containing only *list types*, that is, $[T]$ for any type T . The morphisms in \mathbf{Lst} are functions defined on list types, that is, functions $[T] \rightarrow [U]$ for types T, U . How does this tie into the Haskell typeclass Functor? Recall its definition:

```
class Functor (f :: * -> *) where
  fmap :: (a -> b) -> f a -> f b
```

Let's have a sample instance, too:

² Chapter 59.4 on page 453

```
instance Functor Maybe where
  fmap f (Just x) = Just (f x)
  fmap _ Nothing  = Nothing
```

Here's the key part: the *type constructor* `Maybe` takes any type `T` to a new type, `Maybe T`. Also, `fmap` restricted to `Maybe` types takes a function `a -> b` to a function `Maybe a -> Maybe b`. But that's it! We've defined two parts, something that takes objects in **Hask** to objects in another category (that of `Maybe` types and functions defined on `Maybe` types), and something that takes morphisms in **Hask** to morphisms in this category. So `Maybe` is a functor.

A useful intuition regarding Haskell functors is that they represent types that can be mapped over. This could be a list or a `Maybe`, but also more complicated structures like trees. A function that does some mapping could be written using `fmap`, then any functor structure could be passed into this function. E.g. you could write a generic function that covers all of `Data.List.map`, `Data.Map.map`, `Data.Array.IArray.amap`, and so on.

What about the functor axioms? The polymorphic function `id` takes the place of id_A for any `A`, so the first law states:

```
fmap id = id
```

With our above intuition in mind, this states that mapping over a structure doing nothing to each element is equivalent to doing nothing overall. Secondly, morphism composition is just `(.)`, so

```
fmap (f . g) = fmap f . fmap g
```

This second law is very useful in practice. Picturing the functor as a list or similar container, the right-hand side is a two-pass algorithm: we map over the structure, performing `g`, then map over it again, performing `f`. The functor axioms guarantee we can transform this into a single-pass algorithm that performs `f . g`. This is a process known as *fusion*.

Exercises:

Check the laws for the `Maybe` and list functors.

59.2.2 Translating categorical concepts into Haskell

Functors provide a good example of how category theory gets translated into Haskell. The key points to remember are that:

- We work in the category **Hask** and its subcategories.
- Objects are types.
- Morphisms are functions.
- Things that take a type and return another type are type constructors.
- Things that take a function and return another function are higher-order functions.

- Typeclasses, along with the polymorphism they provide, make a nice way of capturing the fact that in category theory things are often defined over a number of objects at once.

59.3 Monads

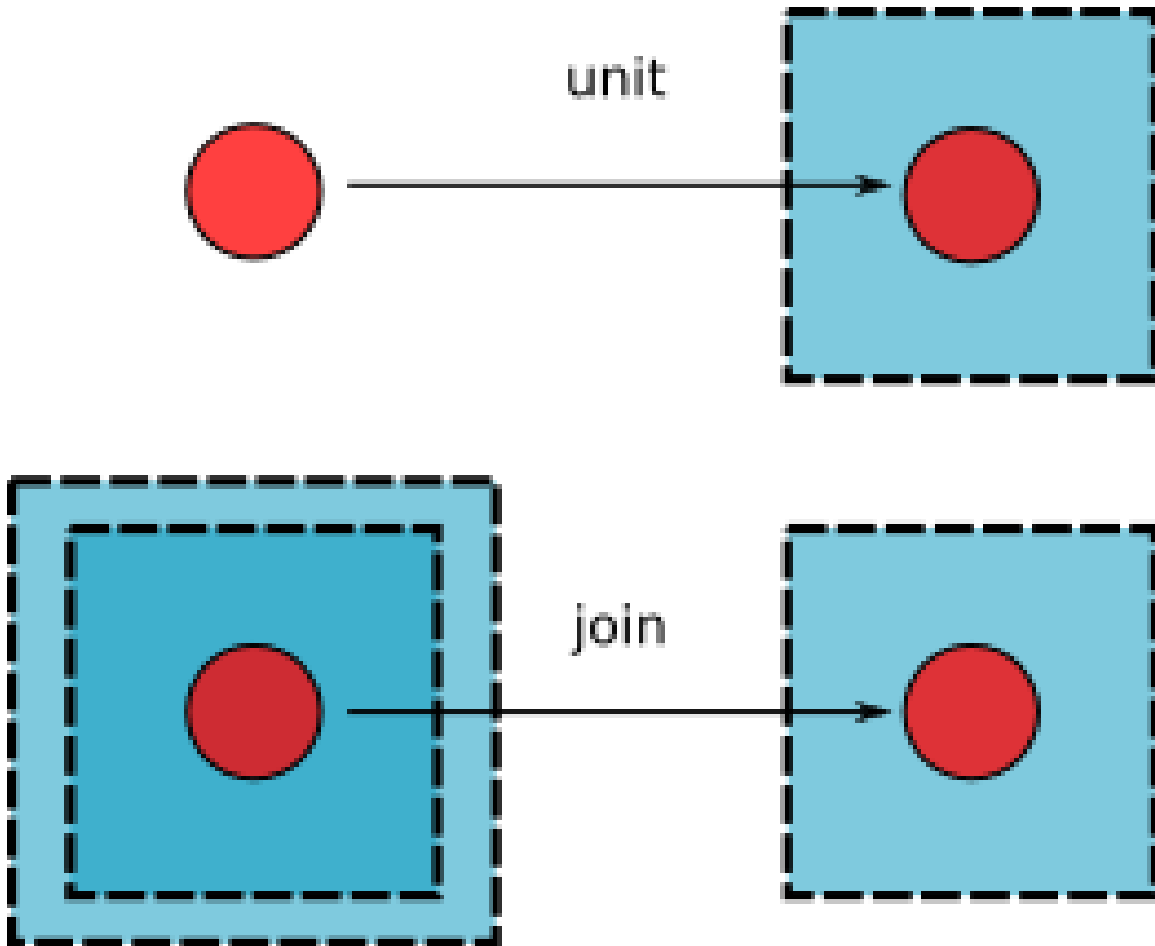

Figure 33 *unit* and *join*, the two morphisms that must exist for every object for a given monad.

Monads are obviously an extremely important concept in Haskell, and in fact they originally came from category theory. A *monad* is a special type of functor, from a category to that same category, that supports some additional structure. So, down to definitions. A monad is a functor $M : C \rightarrow C$, along with two morphisms³ for every object X in C :

- $\text{unit}_X^M : X \rightarrow M(X)$

³ Experienced category theorists will notice that we're simplifying things a bit here; instead of presenting *unit* and *join* as natural transformations, we treat them explicitly as morphisms, and require naturality as extra axioms alongside the standard monad laws (laws 3 and 4) ^{Chapter59.4.3 on page 456}. The reasoning is simplicity; we are not trying to teach category theory as a whole, simply give a categorical background to some of the structures in Haskell. You may also notice that we are giving these morphisms names suggestive of their Haskell analogues, because the names η and μ don't provide much intuition.

- $\text{join}_X^M : M(M(X)) \rightarrow M(X)$

When the monad under discussion is obvious, we'll leave out the M superscript for these functions and just talk about unit_X and join_X for some X .

Let's see how this translates to the Haskell typeclass `Monad`, then.

```
class Functor m => Monad m where
  return :: a -> m a
  (>>=)  :: m a -> (a -> m b) -> m b
```

The class constraint of `Functor m` ensures that we already have the functor structure: a mapping of objects and of morphisms. `return` is the (polymorphic) analogue to unit_X for any X . But we have a problem. Although `return`'s type looks quite similar to that of *unit*; the other function, `(>>=)`, often called *bind*, bears no resemblance to *join*. There is however another monad function, `join :: Monad m => m (m a) -> m a`, that looks quite similar. Indeed, we can recover `join` and `(>>=)` from each other:

```
join :: Monad m => m (m a) -> m a
join x = x >>= id

(>>=) :: Monad m => m a -> (a -> m b) -> m b
x >>= f = join (fmap f x)
```

So specifying a monad's `return`, `fmap`, and `join` is equivalent to specifying its `return` and `(>>=)`. It just turns out that the normal way of defining a monad in category theory is to give *unit* and *join*, whereas Haskell programmers like to give `return` and `(>>=)`.⁴ Often, the categorical way makes more sense. Any time you have some kind of structure M and a natural way of taking any object X into $M(X)$, as well as a way of taking $M(M(X))$ into $M(X)$, you probably have a monad. We can see this in the following example section.

59.3.1 Example: the powerset functor is also a monad

The power set functor $P : \mathbf{Set} \rightarrow \mathbf{Set}$ described above forms a monad. For any set S you have a $\text{unit}_S(x) = \{x\}$, mapping elements to their singleton set. Note that each of these singleton sets are trivially a subset of S , so unit_S returns elements of the powerset of S , as is required. Also, you can define a function join_S as follows: we receive an input $L \in \mathcal{P}(\mathcal{P}(S))$. This is:

- A member of the powerset of the powerset of S .
- So a member of the set of all subsets of the set of all subsets of S .
- So a set of subsets of S

We then return the union of these subsets, giving another subset of S . Symbolically,

⁴ This is perhaps due to the fact that Haskell programmers like to think of monads as a way of sequencing computations with a common feature, whereas in category theory the container aspect of the various structures is emphasised. `join` pertains naturally to containers (squashing two layers of a container down into one), but `(>>=)` is the natural sequencing operation (do something, feeding its results into something else).

$$\text{join}_S(L) = \bigcup L$$

Hence P is a monad ⁵.

In fact, P is almost equivalent to the list monad; with the exception that we're talking lists instead of sets, they're almost the same. Compare:

Power set functor on Set	
Function type	Definition
Given a set S and a morphism $f : A \rightarrow B$:	
$P(f) : \mathcal{P}(A) \rightarrow \mathcal{P}(B)$	$(P(f))(S) = \{f(a) : a \in S\}$
$\text{unit}_S : S \rightarrow \mathcal{P}(S)$	$\text{unit}_S(x) = \{x\}$
$\text{join}_S : \mathcal{P}(\mathcal{P}(S)) \rightarrow \mathcal{P}(S)$	$\text{join}_S(L) = \bigcup L$
List monad from Haskell	
Function type	Definition
Given a type T and a function $f :: A \rightarrow B$	
<code>fmap f :: [A] -> [B]</code>	<code>fmap f xs = [f a a <- xs]</code>
<code>return :: T -> [T]</code>	<code>return x = [x]</code>
<code>join :: [[T]] -> [T]</code>	<code>join xs = concat xs</code>

59.4 The monad laws and their importance

Just as functors had to obey certain axioms in order to be called functors, monads have a few of their own. We'll first list them, then translate to Haskell, then see why they're important.

Given a monad $M : C \rightarrow C$ and a morphism $f : A \rightarrow B$ for $A, B \in C$,

1. $\text{join} \circ M(\text{join}) = \text{join} \circ \text{join}$
2. $\text{join} \circ M(\text{unit}) = \text{join} \circ \text{unit} = \text{id}$
3. $\text{unit} \circ f = M(f) \circ \text{unit}$
4. $\text{join} \circ M(M(f)) = M(f) \circ \text{join}$

By now, the Haskell translations should be hopefully self-explanatory:

1. `join . fmap join = join . join`
2. `join . fmap return = join . return = id`
3. `return . f = fmap f . return`
4. `join . fmap (fmap f) = fmap f . join`

(Remember that `fmap` is the part of a functor that acts on morphisms.) These laws seem a bit impenetrable at first, though. What on earth do these laws mean, and why should they be true for monads? Let's explore the laws.

⁵ If you can prove that certain laws hold, which we'll explore in the next section.

59.4.1 The first law

`join . fmap join = join . join`

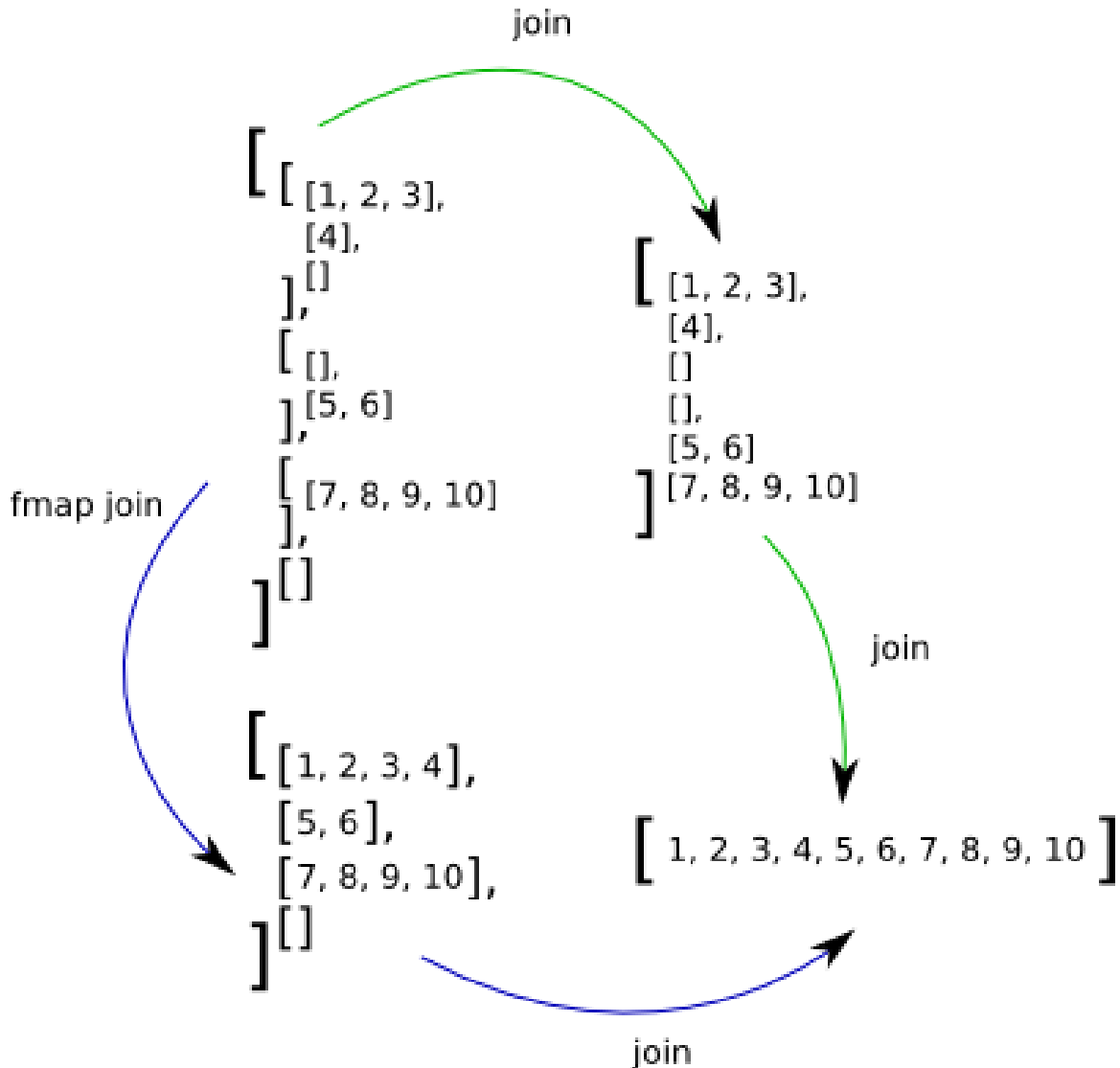

Figure 34 A demonstration of the first law for lists. Remember that `join` is `concat` and `fmap` is `map` in the list monad.

In order to understand this law, we'll first use the example of lists. The first law mentions two functions, `join . fmap join` (the left-hand side) and `join . join` (the right-hand side). What will the types of these functions be? Remembering that `join`'s type is `[[a]] -> [a]` (we're talking just about lists for now), the types are both `[a6] -> [a]` (the fact that they're the same is handy; after all, we're trying to show they're completely the same function!). So we have a list of lists of lists. The left-hand side, then, performs `fmap join` on this 3-layered list, then uses `join` on the result. `fmap` is just the familiar `map` for lists, so we first map across each of the list of lists inside the top-level list, concatenating

6 <https://en.wikibooks.org/wiki/a>

them down into a list each. So afterward, we have a list of lists, which we then run through `join`. In summary, we 'enter' the top level, collapse the second and third levels down, then collapse this new level with the top level.

What about the right-hand side? We first run `join` on our list of list of lists. Although this is three layers, and you normally apply a two-layered list to `join`, this will still work, because a `[a7]` is just `[[b]]`, where `b = [a]`, so in a sense, a three-layered list is just a two-layered list, but rather than the last layer being 'flat', it is composed of another list. So if we apply our list of lists (of lists) to `join`, it will flatten those outer two layers into one. As the second layer wasn't flat but instead contained a third layer, we will still end up with a list of lists, which the other `join` flattens. Summing up, the left-hand side will flatten the inner two layers into a new layer, then flatten this with the outermost layer. The right-hand side will flatten the outer two layers, then flatten this with the innermost layer. These two operations should be equivalent. It's sort of like a law of associativity for `join`.

Maybe is also a monad, with

```
return :: a -> Maybe a
return x = Just x

join :: Maybe (Maybe a) -> Maybe a
join Nothing          = Nothing
join (Just Nothing)  = Nothing
join (Just (Just x)) = Just x
```

So if we had a *three*-layered `Maybe` (i.e., it could be `Nothing`, `Just Nothing`, `Just (Just Nothing)` or `Just (Just (Just x))`), the first law says that collapsing the inner two layers first, then that with the outer layer is exactly the same as collapsing the outer layers first, then that with the innermost layer.

Exercises:

Verify that the list and `Maybe` monads do in fact obey this law with some examples to see precisely how the layer flattening works.

59.4.2 The second law

```
join . fmap return = join . return = id
```

What about the second law, then? Again, we'll start with the example of lists. Both functions mentioned in the second law are functions `[a] -> [a]`. The left-hand side expresses a function that maps over the list, turning each element `x` into its singleton list `[x]`, so that at the end we're left with a list of singleton lists. This two-layered list is flattened down into a single-layer list again using the `join`. The right hand side, however, takes the entire list `[x, y, z, ...]`, turns it into the singleton list of lists `[[x, y, z, ...]]`, then flattens the two layers down into one again. This law is less obvious to state quickly, but it essentially says that applying `return` to a monadic value, then `joining` the result should have the same effect whether you perform the `return` from inside the top layer or from outside it.

7 <https://en.wikibooks.org/wiki/a>

Exercises:

Prove this second law for the Maybe monad.

59.4.3 The third and fourth laws

```
return . f = fmap f . return
```

```
join . fmap (fmap f) = fmap f . join
```

The last two laws express more self evident fact about how we expect monads to behave. The easiest way to see how they are true is to expand them to use the expanded form:

1. $\backslash x \rightarrow \text{return } (f \ x) = \backslash x \rightarrow \text{fmap } f \ (\text{return } \ x)$
2. $\backslash x \rightarrow \text{join } (\text{fmap } (\text{fmap } f) \ x) = \backslash x \rightarrow \text{fmap } f \ (\text{join } \ x)$

Exercises:

Convince yourself that these laws should hold true for any monad by exploring what they mean, in a similar style to how we explained the first and second laws.

59.4.4 Application to do-blocks

Well, we have intuitive statements about the laws that a monad must support, but why is that important? The answer becomes obvious when we consider do-blocks. Recall that a do-block is just syntactic sugar for a combination of statements involving ($\gg=$) as witnessed by the usual translation:

```
do { x }                --> x
do { let { y = v }; x } --> let y = v in do { x }
do { v <- y; x }        --> y >>= \v -> do { x }
do { y; x }             --> y >>= \_ -> do { x }
```

Also notice that we can prove what are normally quoted as the monad laws using `return` and ($\gg=$) from our above laws (the proofs are a little heavy in some cases, feel free to skip them if you want to):

1. `return x >>= f = f x`. Proof:

```
return x >>= f
= join (fmap f (return x)) -- By the definition of (>>=)
= join (return (f x))      -- By law 3
= (join . return) (f x)
= id (f x)                -- By law 2
= f x
```

2. `m >>= return = m`. Proof:

```
m >>= return
= join (fmap return m)    -- By the definition of (>>=)
= (join . fmap return) m
= id m                    -- By law 2
= m
```

3. $(m \gg= f) \gg= g = m \gg= (\lambda x \rightarrow f\ x \gg= g)$. Proof (recall that $fmap\ f \ .\ fmap\ g = fmap\ (f \ .\ g)$):

```

(m >>= f) >>= g
= (join (fmap f m)) >>= g           -- By the definition of
(>>=)
= join (fmap g (join (fmap f m)))   -- By the definition of
(>>=)
= (join . fmap g) (join (fmap f m))
= (join . fmap g . join) (fmap f m)
= (join . join . fmap (fmap g)) (fmap f m) -- By law 4
= (join . join . fmap (fmap g) . fmap f) m
= (join . join . fmap (fmap g . f)) m     -- By the distributive law
of functors
= (join . join . fmap (\x -> fmap g (f x))) m
= (join . fmap join . fmap (\x -> fmap g (f x))) m -- By law 1
= (join . fmap (join . (\x -> fmap g (f x)))) m -- By the distributive law
of functors
= (join . fmap (\x -> join (fmap g (f x)))) m
= (join . fmap (\x -> f x >>= g)) m       -- By the definition of
(>>=)
= join (fmap (\x -> f x >>= g) m)
= m >>= (\x -> f x >>= g)               -- By the definition of
(>>=)

```

These new monad laws, using `return` and `(>>=)`, can be translated into do-block notation.

Points-free style	Do-block style
<code>return x >>= f = f x</code>	<code>do { v <- return x; f v } = do { f x }</code>
<code>m >>= return = m</code>	<code>do { v <- m; return v } = do { m }</code>
<code>(m >>= f) >>= g = m >>= (\x -> f x >>= g)</code>	<pre> do { y <- do { x <- m; f x }; g y } = do { x <- m; y <- f x; g y } </pre>

The monad laws are now common-sense statements about how do-blocks should function. If one of these laws were invalidated, users would become confused, as you couldn't be able to manipulate things within the do-blocks as would be expected. The monad laws are, in essence, usability guidelines.

Exercises:

In fact, the two versions of the laws we gave:

```
-- Categorical:
join . fmap join = join . join
join . fmap return = join . return = id
return . f = fmap f . return
join . fmap (fmap f) = fmap f . join

-- Functional:
m >>= return = m
return m >>= f = f m
(m >>= f) >>= g = m >>= (\x -> f x >>= g)
```

are entirely equivalent. We showed that we can recover the functional laws from the categorical ones. Go the other way; show that starting from the functional laws, the categorical laws hold. It may be useful to remember the following definitions:

```
join m = m >>= id
fmap f m = m >>= return . f
```

Thanks to Yitzchak Gale for suggesting this exercise.

59.5 Summary

We've come a long way in this chapter. We've looked at what categories are and how they apply to Haskell. We've introduced the basic concepts of category theory including functors, as well as some more advanced topics like monads, and seen how they're crucial to idiomatic Haskell. We haven't covered some of the basic category theory that wasn't needed for our aims, like natural transformations, but have instead provided an intuitive feel for the categorical grounding behind Haskell's structures.

60 The Curry-Howard isomorphism

The **Curry–Howard isomorphism** is a striking relationship connecting two seemingly unrelated areas of mathematics — type theory and structural logic.

60.1 Introduction

The Curry–Howard isomorphism, hereafter referred to as simply CH, tells us that in order to prove any mathematical theorem, all we have to do is construct a certain type which reflects the nature of that theorem, then find a value that has that type. This seems extremely weird at first: what do types have to do with theorems? However, as we shall see, the two are very closely related. A quick note before we begin: for these introductory paragraphs, we ignore the existence of expressions like `error` and `undefined` whose denotational semantics¹ are \perp . These have an extremely important role, but we will consider them separately in due time. We also ignore functions that bypass the type system like `unsafeCoerce#`.

We can build incredibly complicated types using Haskell's higher-order functions² feature. We might want to ask the question: given an arbitrary type, under what conditions does there exist a value with that type (we say the type is *inhabited*)? A first guess might be 'all the time', but this quickly breaks down under examples. For example, there is no function with type `a -> b`, because we have no way of turning something of type `a` into something of a completely different type `b` (unless we know in advance which types `a` and `b` are, in which case we're talking about a monomorphic function, such as `ord :: Char -> Int`).

Incredibly, it turns out that a type is only inhabited when it corresponds to a true theorem in mathematical logic. But what is the nature of this correspondence? What does a type like `a -> b` mean in the context of logic?

60.1.1 A crash course in formal logic

We need some background on formal logic before we can begin to explore its relationship to type theory. This is a *very* brief introduction; for a wider grounding we recommend you consult an introductory textbook on the subject matter.

In everyday language we use a lot of 'If... then...' sentences. For example, 'If the weather is nice today, then we'll walk into town'. These kinds of statements also crop up in mathematics; we can say things like 'If x is positive, then it has a (real) square-root'. Formal logic is a way of representing statements which approximate English meanings with a Boolean logic on which we can do computations. We use the $A \rightarrow B$ sign (read as 'A implies B') to indicate

¹ Chapter 58 on page 417

² Chapter 19 on page 127

that B is true whenever A is true. For example, our earlier statement could be recast as ' x is positive $\rightarrow x$ has a real square-root ', meaning the number's positivity implies the existence of the desired kind of root. We'll often use letters to stand for entire statements, so for example if W is the statement 'the weather is nice', and T is the statement 'we'll walk into town', then we could say $W \rightarrow T$.

Our definition of $P \rightarrow Q$ has some flaws. If Q is some statement that is always true, no matter what the circumstances — like 'the sun is hot' — then it doesn't matter what P is. P could even be a false statement, Q would still be true if P were true, so the implication $P \rightarrow Q$ is not considered to be proved wrong. $P \rightarrow Q$ is defined to be true whenever P is false and whenever Q is true. So \rightarrow doesn't really represent any kind of cause-effect relationship; things like 'the sky is pink \rightarrow the sun is hot' are defined to be true. There are other logical algebras besides Boolean logic which try to fix these "problems"³ and we can also construct them in Haskell.

Other things that crop up lots in both everyday language and mathematics are things called conjunctions and disjunctions. The former represent statements involving an 'and', the latter statements involving an 'or'. We could represent the statement 'I will buy this magazine if it's in stock and I have enough money' by the symbolism $(M \wedge S) \rightarrow B$, where M = 'I have enough money', S = 'The magazine is in stock', B = 'I will buy the magazine'. Essentially, one can just read the symbol \wedge as 'and'. Similarly, one can read the symbol \vee as 'or', so that the statement 'I will either walk or get the train to work or both' could be represented as $W \vee T$, where W = 'I will walk to work', and T = 'I will get the train to work'.

Using these symbols, and a few more which will be introduced as we go, we can produce arbitrarily complicated symbol strings. There are two classes of these symbol strings: those that represent true statements, often called the **theorems**; and those which represent false statements, called the **nontheorems**. Note that whether a symbol string is a theorem or nontheorem depends on what the letters stand for, so $P \vee Q$ is a theorem if, for example, P represents the statement 'It is daytime' and Q represents the statement 'It is night time' (ignoring exceptions like twilight), but it would be a nontheorem if P were 'Trees are blue' and Q were 'All birds can fly'. We'll often call a symbol string a **proposition** if we don't know whether it's a theorem or not.

There are *many* more subtleties to the subject of logic (including the fact that when we say 'If you eat your dinner you'll get dessert' we actually mean 'Only if you eat your dinner will you get dessert!'). If this is a subject that interests you, there are many textbooks around that comprehensively cover the subject.

3 Another way of looking at this is that we're trying to *define* our logical operator \rightarrow such that it captures our intuition of the "if... then" construct in natural language. So we want statements like for all naturals x , " x is even" \rightarrow " $x + 1$ is odd" to be true. I.e. that implication must hold when we substitute x for any natural including, say, 5. But "5 is even" and "6 is odd" are both false, so we must have that False \rightarrow False is true. Similarly by considering the statement for all naturals $x > 3$, " x is prime" \rightarrow " $x + 1$ is not prime", we must have that False \rightarrow True is true. And obviously True \rightarrow True must be true, and True \rightarrow False is false. So we have that $x \rightarrow y$ unless x is true and y false.

60.1.2 Propositions are types

So, given a type $a \rightarrow b$, what does that mean in terms of symbolistic logic? Handily, it simply means that $a \rightarrow b$. Of course, this only makes sense if a and b are types which can further be interpreted in our symbolistic logic. This is the essence of CH. Furthermore, as we mentioned before, $a \rightarrow b$ is a theorem if and only if $a \rightarrow b$ is an inhabited type.

Let's see this using one of the simplest of Haskell functions. `const` has the type $a \rightarrow b \rightarrow a$. Translated into logic, we have that $a \rightarrow b \rightarrow a$. This must be a theorem, as the type $a \rightarrow b \rightarrow a$ is inhabited by the value `const`. Now, another way of expressing $a \rightarrow b$ is that 'If we assume a is true, then b must be true.' So $a \rightarrow b \rightarrow a$ means that if we assume a is true, then if we further assume that b is true, then we can conclude a . This is of course a theorem; we assumed a , so a is true under our assumptions.

60.1.3 The problem with \perp

We've mentioned that a type corresponds to a theorem if that type is inhabited. However, in Haskell, every type is inhabited by the value `undefined`. Indeed, more generally, anything with type `forall a. a`, a value with denotational semantics of \perp , is a problem. \perp in type theory corresponds to inconsistency in logic; we can prove any theorem using Haskell types because every type is inhabited. Therefore, Haskell's type system actually corresponds to an inconsistent logic system. However, if we work with a limited subset of Haskell's type system, and in particular disallow polymorphic types, we have a consistent logic system we can do some cool stuff in. Hereafter it is assumed we are working in such a type system.

Now that we have the basics of CH, we can begin to unpack a little more the relationship between types and propositions.

60.2 Logical operations and their equivalents

The essence of symbolic logic is a set of propositions, such as P and Q , and different ways of combining these propositions such as $Q \rightarrow P$ or $P \vee Q$. These ways of combining propositions can be thought of as operations on propositions. By CH, propositions correspond to types, so we should have that the CH equivalents of these proposition combinators are type operations, more normally known as type constructors. We've already seen an example of this: the implication operator \rightarrow in logic corresponds to the type constructor (\rightarrow) . The rest of this section proceeds to explore the rest of the proposition combinators and explain their correspondence.

60.2.1 Conjunction and Disjunction

In order for $A \wedge B$ to be a theorem, both A and B must be theorems. So a proof for $A \wedge B$ amounts to proving both A and B . Remember that to prove a proposition A we find a value of type A , where A and A are CH correspondents. So in this instance we wish to find a value that contains two sub-values: the first whose type corresponds to A , and the second whose type corresponds to B . This sounds remarkably like a pair. Indeed, we represent the symbol string $A \wedge B$ by (a, b) , where a corresponds to A and b corresponds to B .

Disjunction is opposite to conjunction. In order for $A \vee B$ to be a theorem, either A or B must be a theorem. Again, we search for a value which contains either a value of type A or a value of type B . This is `Either`. `Either A B` is the type which corresponds to the proposition $A \vee B$.

60.2.2 Falsity

It is occasionally useful to represent a false statement in our logic system. By definition, a false statement is one that can't be proven. So we're looking for a type which isn't inhabited. Although none of these types exist in the default libraries (don't get confused with the `()` type, which has precisely one value), we can define one (or for older versions of GHC that does not support Haskell2010, we turn on the `-XEmptyDataDecls` flag):

```
data Void
```

The effect of omitting the constructors means that `Void` is an uninhabited type. So the `Void` type corresponds to a nontheorem in our logic. There are a few handy corollaries here:

1. `(Void, A)` and `(A, Void)` are both uninhabited types for any type A , corresponding to the fact that $F \wedge A$ and $A \wedge F$ are both nontheorems if F is a nontheorem.
2. `Either Void A` and `Either A Void` are essentially the same as A for any type A ,⁴ corresponding to the fact that $F \vee A$ and $A \vee F$, where F is a nontheorem, are theorems only if A is a theorem.
3. Any type that corresponds to a nontheorem can be replaced with `Void`. This is because any nontheorem-type must be uninhabited, so replacing it with `Void` everywhere doesn't change anything. `Void` is really equivalent to any nontheorem type⁵.
4. As we remarked in the first section, the implication $P \rightarrow Q$ is true if Q is true, regardless of the truth value of P . So we should be able to find a term with type `Void -> a`. In fact one does exist, but it's somewhat complicated to explain: the answer is the *empty function*. We can define a function `f :: A -> B` as a (probably infinite) set of pairs whose first element is an element of A (the *domain*) and second element is `f`'s output on this term, an element of B (the *codomain*). For example, the successor function on the naturals is represented as $\{(0,1), (1,2), (2,3), \dots\}$. Note that in order to be a (total and well-defined) function, we must have precisely one pair $(a, f\ a)$ for each term a with type A .

The empty function, let's call it `empty` is represented in this way by the empty set. But as we must have a pair for each element of the domain, and there no pairs in our representation, the domain type must be empty, i.e. `Void`. What about the range type? `empty` never produces any output, so there are no restrictions placed on the range type. Thus, it is valid to assume that the range type has any type, so we can say `empty :: forall a. Void -> a`. Unfortunately, it's not possible to write this

4 Technically, the types `Either Void A` and A are isomorphic. Seeing as you can't have a value of type `Void`, every value in `Either Void A` must be a `Right`-tagged value, so the transformation just strips the `Right` constructors.

5 Again, the technical statement is that `Void` is isomorphic to any type which is a nontheorem.

function in Haskell; we'd ideally like to write something like:

```
empty :: Void -> a
```

And stop there, but this is illegal Haskell. The closest we can come is the following:

```
empty :: Void -> a
empty _ = undefined
```

Alternatively:

```
empty :: Void -> a
empty = empty
```

Another reasonable way would be to write (valid in GHC with EmptyCase extension):

```
empty x = case x of { }
```

The case statement is perfectly well formed since it handles every possible value of `x`. Note that this is perfectly safe, since the right-hand side of this function can never be reached (since we have nothing to pass it). So, the conclusion of all this is that `Void -> a` is an inhabited type, just as $P \rightarrow Q$ is true if P is false.

60.2.3 Negation

The \neg operation in logic turns theorems into nontheorems and vice versa: if A is a theorem then $\neg A$ is a nontheorem; if A is a nontheorem then $\neg A$ is a theorem. How can we represent this in Haskell? The answer's a sneaky one. We define a type synonym:

```
type Not a = a -> Void
```

So for a type `A`, `Not A` is just `A -> Void`. How does this work? Well, if `A` was a theorem-type, then `A -> Void` must be uninhabited: there's no way any function could return any value, because the return type, `Void` has no values (The function has to provide values for all inhabitants of `A`)! On the other hand, if `A` was a nontheorem, then `A` can be replaced with `Void` as we explored in the last section. Then the function `id :: Void -> Void` is an inhabitant of `Not A`, so `Not A` is a theorem as required (The function doesn't have to provide any values, since there are no inhabitants in its domain. Nevertheless it's a function — with an empty graph).

60.3 Axiomatic logic and the combinatory calculus

So far we've only used some very basic features from Haskell's type system. Indeed, most of the features of logic we've mentioned can be explored using a very basic 'programming language', the combinator calculus. To fully appreciate how closely CH ties together these

two areas of mathematics, we need to *axiomatise* both our discussion of formal logic and our discussion of programming languages.

60.3.1 Axiomatic logic

We start with two axioms about how the \rightarrow operation should behave (from now on, we assume that \rightarrow is a right-associative function, i.e. $A \rightarrow B \rightarrow C$ means $A \rightarrow (B \rightarrow C)$):

1. $A \rightarrow B \rightarrow A$
2. $(A \rightarrow B \rightarrow C) \rightarrow (A \rightarrow B) \rightarrow A \rightarrow C$

The first axiom says that given any two propositions A and B , if we assume both A and B , we know that A is true. The second says that if A implies that B implies C (or equivalently, if C is true whenever A and B are true), and A itself implies B , then knowing A is true would be enough to conclude that C is true. This may seem complicated, but a bit of thought reveals it to be common sense. Imagine we have a collection of boxes of various colours, some with wheels, some with lids, such that all the red boxes with wheels also have lids, and all the red boxes have wheels. Pick one box. Let $A =$ 'The box under consideration is red', $B =$ 'The box under consideration has wheels', $C =$ 'The box under consideration has a lid'. Then the second law tells us that, as $A \rightarrow B \rightarrow C$ (all red boxes with wheels also have lids), and $A \rightarrow B$ (all red boxes have wheels), then if A (if the box is red), then C must be true (the box has a lid).

We also allow one *inference law*, called *modus ponens*:

1. If $A \rightarrow B$, and A , then B .

This law allows us to create new theorems given old one. It should be fairly obvious; it is essentially the definition of what \rightarrow means. This small basis provides a simple enough logic system which is expressive enough to cover most of our discussions. Here's a sample proof of the law $A \rightarrow A$ in our system:

Firstly, we know the two axioms to be theorems:

- $A \rightarrow B \rightarrow A$
- $(A \rightarrow B \rightarrow C) \rightarrow (A \rightarrow B) \rightarrow A \rightarrow C$

You'll notice that the left-hand side of the second axiom looks a bit like the first axiom. The second axiom guarantees that if we know that $A \rightarrow B \rightarrow C$, then we can conclude $(A \rightarrow B) \rightarrow A \rightarrow C$. In this case, if we let C be the same proposition as A , then we have that if $A \rightarrow B \rightarrow A$, then $(A \rightarrow B) \rightarrow A \rightarrow A$. But we already know $A \rightarrow B \rightarrow A$, that was the first axiom. Therefore, we have that $(A \rightarrow B) \rightarrow A \rightarrow A$ is a theorem. If we further let B be the proposition $C \rightarrow A$, for some other proposition C , then we have that if $A \rightarrow C \rightarrow A$, then $A \rightarrow A$. But, again, we know that $A \rightarrow C \rightarrow A$ (it's the first axiom again), so $A \rightarrow A$, as we wanted.

This example demonstrates that given some simple axioms and a simple way to make new theorems from old, we can derive more complicated theorems. It may take a while to get there — here we had several lines of reasoning to prove just that the obvious statement $A \rightarrow A$ is a theorem! — but we get there in the end. This kind of formalisation is attractive because we have essentially defined a very simple system, and it is very easy to study how that system works.

60.3.2 Combinator calculus

The lambda calculus⁶ is a way of defining a simple programming language from a very simple basis. If you haven't already read the chapter that was just linked to, we recommend you read at least the introductory sections on the untyped version of the calculus. Here's a refresher in case you're feeling dusty. A lambda term is one of three things:

- A *value*, v .
- A *lambda abstraction* $\lambda x.t$, where t is another lambda term.
- An *application* $(t_1 t_2)$, where t_1 and t_2 are lambda terms.

There is one reduction law, too, called *beta-reduction*:

- $((\lambda x.t_1)t_2) \rightarrow t_1[x := t_2]$, where $t_1[x := t_2]$ means t_1 with all the free occurrences of x replaced with t_2 .

As mentioned in the lambda calculus⁷ article, the difficulty comes when trying to pin down the notion of a free occurrence of an identifier. The combinator calculus was invented by the American mathematician Haskell Curry (after whom a certain programming language is named) because of these difficulties. There are many variants on the basic combinator calculus, but we consider one of the simplest here. We start with two so-called **combinators**:

- **K** takes two values and returns the first. In the lambda calculus, $\mathbf{K} = \lambda xy. x$.
- **S** takes a binary function, a unary function and a value, and applies that value and the value passed into the unary function to the binary function. again, in the lambda calculus: $\mathbf{S} = \lambda xyz. xz(yz)$.

The first function you should recognise as `const`. The second is more complicated, it is the monadic function `ap` in the $((\rightarrow) \text{e})$ monad (which is essentially `Reader`). These two combinators form a complete basis for the entire lambda calculus. Every lambda calculus program can be written using just these two functions.

60.4 Sample proofs

60.5 Intuitionistic vs classical logic

So far, all of the results we have proved are theorems of intuitionistic logic. Let's see what happens when we try to prove the basic theorem of classical logic, `Not Not A -> A`. Recall that this translates as $((A \rightarrow \text{Void}) \rightarrow \text{Void}) \rightarrow A$. So, given a function of type $(A \rightarrow \text{Void}) \rightarrow \text{Void}$ we need a function of type A . Now a function of type $(A \rightarrow \text{Void}) \rightarrow \text{Void}$ exists precisely if type $A \rightarrow \text{Void}$ is uninhabited, or in other words if type A is inhabited. So we need a function which takes any inhabited type, and returns an element of that type. Although it is simple enough to do this on a computer - we need only find the "simplest" or "first" inhabitant of each type - there is no way to do this using standard lambda-calculus or combinator techniques. So we see that this result cannot be proved

⁶ <https://en.wikibooks.org/wiki/Lambda%20Calculus>

⁷ <https://en.wikibooks.org/wiki/Lambda%20Calculus>

using these two techniques, and hence that the underlying logic is intuitionistic rather than classical.

Instead, consider a traditional error handling function which calls `throw` when an error occurs, transferring computation to `catch`. The `throw` function cancels any return value from the original function, so it has type `A -> Void`, where `A` is the type of its arguments. The `catch` function then takes the `throw` function as its argument, and, if the `throw` triggers (i.e. returns a `Void`) will return the argument of the `throw` function. So the type of `catch` is `((A -> Void) -> Void) -> A`.⁸

⁸ This argument is taken from Dan Piponi . *Adventures in Classical Land* *Adventures in Classical Land* .
The Monad Reader ,

(+) is an eager function, so it needs full value of x *before* it can compute ... *the value of x* . It's clear that this calculation will never stop. Let's expand the next example:

```
fix (const "hello")
= let {x = const "hello" x} in x
= "hello"
```

This is quite different: we can see after one expansion of the definition of `fix` that because `const` ignores its second argument, the evaluation concludes. The evaluation for the last example is a little different, but we can proceed similarly:

```
fix (1:)
= let {x = 1 : x} in x
= let {x = 1 : x} in 1 : x
```

Here `1 : x` is already in weak head normal form (`(:)` is a lazy data constructor), so the expansion stops. This actually creates a cyclic structure. Each time new element of this list is requested by a consumer function, `x`'s definition is consulted, and it is already known to be `1 : x`.

Thus, requesting elements from this list one by one will return 1s one after another while requested, without limit. So `take 10 (fix (1:))` will produce a list of ten 1s, but trying to print them all by typing `fix (1:)` into GHCi causes the infinite stream of 1s to be printed.

Well actually it causes the evaluation of `show (fix (1:)) = "[" ++ intercalate ",," (map show (fix (1:))) ++ "]"`, and although the `map show (fix (1:))` will never terminate, it does produce its output incrementally, piece by piece, one "1" at a time:

```
"[" ++ intercalate ",," (map show (fix (1:))) ++ "]"
= "[" ++ intercalate ",," (map show (let {x = 1 : x} in x)) ++ "]"
= "[" ++ intercalate ",," (map show (let {x = 1 : x} in 1 : x)) ++ "]"
= "[" ++ "1" ++ ",," ++ intercalate ",," (map show (let {x = 1 : x} in x)) ++ "]"

= "[1," ++ intercalate ",," (map show (let {x = 1 : x} in 1 : x)) ++ "]"
= "[1," ++ "1" ++ ",," ++ intercalate ",," (map show (let {x = 1 : x} in x)) ++ "]"
= "[1,1," ++ intercalate ",," (map show (let {x = 1 : x} in 1 : x)) ++ "]"
= "[1,1," ++ "1" ++ ",," ++ intercalate ",," (map show (let {x = 1 : x} in x)) ++ "]"
= "[1,1,1," ++ intercalate ",," (map show (let {x = 1 : x} in 1 : x)) ++ "]"
= ...
```

This is lazy evaluation at work: the printing function doesn't need to consume its entire input string before beginning to print, it does so as soon as it can start.

Lastly, iteratively calculating an approximation of a square root of a number,

```
-- fix f = let {x = f x} in x
fix (next guess tol val -> if abs(guess^2-val) < tol then guess else
    next ((guess + val / guess) / 2.0) tol val) 2.0 0.0001
25.0
```



```

= (let {next = (\next guess tol val -> if abs(guess^2-val) < tol then guess
else
      next ((guess + val / guess) / 2.0) tol val) next}
  in next) 2.0 0.0001 25.0
= let {next guess tol val = if abs(guess^2-val) < tol then guess else
      next ((guess + val / guess) / 2.0) tol val}
  in next 2.0 0.0001 25.0
= 5.000000000016778

```

Exercises:

What, if anything, will the following expressions converge to?

- `fix ("hello"++)`
- `fix (\x -> cycle (1:x))`
- `fix reverse`
- `fix id`
- `fix (\x -> take 2 $ cycle (1:x))`

61.2 fix and fixed points

A *fixed point* of a function `f` is a value `a` such that `f a == a`. For example, 0 is a fixed point of the function `(* 3)` since `0 * 3 == 0`. This is where the name of `fix` comes from: it finds the *least-defined fixed point* of a function. (We'll come to what "least defined" means in a minute.) Notice that for both of our examples above that converge, this is readily seen:

```

const "hello" "hello"
= "hello"

(1:) [1,1,..]
= [1,1,...]

```

And since there's no number `x` such that `2+x == x`, it also makes sense that `fix (2+)` diverges.

Exercises:

For each of the functions `f` in the above exercises for which you decided that `fix f` converges, verify that `fix f` finds a fixed point.

In fact, it's obvious from the definition of `fix` that it finds a fixed point. All we need to do is write the equation for `fix` the other way around:

```
f (fix f) = fix f
```

Which is precisely the definition of a fixed point! So it seems that `fix` should always find a fixed point. But sometimes `fix` seems to fail at this, as sometimes it diverges. We can

repair this property, however, if we bring in some denotational semantics¹. Every Haskell type actually includes a special value called bottom, written \perp . So the values with type, for example, `Int` include, in fact, \perp as well as `1`, `2`, `3` etc.. Divergent computations are denoted by a value of \perp , i.e., we have that `fix (2+)` = \perp .

The special value `undefined` is also denoted by this \perp . Now we can understand how `fix` finds fixed points of functions like `(2+)`:

Example: Fixed points of (2+)

```
Prelude> (2+) undefined
*** Exception: Prelude.undefined
```

So feeding `undefined` (i.e., \perp) to `(2+)` gives us `undefined` back. So \perp is a fixed point of `(2+)`!

In the case of `(2+)`, it is the only fixed point. However, there are other functions `f` with several fixed points for which `fix f` still diverges: `fix (*3)` diverges, but we remarked above that `0` is a fixed point of that function. This is where the "least-defined" clause comes in. Types in Haskell have a partial order² on them called *definedness*. In any type, \perp is the least-defined value (hence the name "bottom"). For simple types like `Int`, the only pairs in the partial order are $\perp \leq 1$, $\perp \leq 2$ and so on. We do not have $m \leq n$ for any non-bottom `Ints` `m`, `n`. Similar comments apply to other simple types like `Bool` and `()`. For "layered" values such as lists or `Maybe`, the picture is more complicated, and we refer to the chapter on denotational semantics³.

So since \perp is the least-defined value for all types and `fix` finds the least-defined fixed point, if `f \perp = \perp` , we will have `fix f = \perp` (and the converse is also true). If you've read the denotational semantics article, you will recognise this as the criterion for a *strict function*: `fix f` diverges if and only if `f` is strict.

61.3 Recursion

If you have already come across examples of `fix`, chances are they were examples involving `fix` and recursion. Here's a classic example:

Example: Encoding recursion with fix

```
Prelude> let fact n = if n == 0 then 1 else n * fact (n-1) in fact 5
120
Prelude> fix (\rec n -> if n == 0 then 1 else n * rec (n-1)) 5
120
```

¹ Chapter 58 on page 417

² http://en.wikipedia.org/wiki/Partial_order

³ Chapter 58 on page 417

Here we have used `fix` to "encode" the factorial function: note that (if we regard `fix` as a language primitive) our second definition of `fact` doesn't involve recursion at all. In a language like the typed lambda calculus that doesn't feature recursion, we can introduce `fix` in to write recursive functions in this way. Here are some more examples:

Example: More `fix` examples

```
Prelude> fix (\rec f l -> if null l then [] else f (head l) : rec f (tail l))
(+1) [1..3]
[2,3,4]
Prelude> map (fix (\rec n -> if n == 1 || n == 2 then 1 else rec (n-1) + rec
(n-2))) [1..10]
[1,1,2,3,5,8,13,21,34,55]
```

So how does this work? Let's first approach it from a denotational point of view with our `fact` function. For brevity let's define:

```
fact' rec n = if n == 0 then 1 else n * rec (n-1)
```

This is the same function as in the first example above, except that we gave a name to the anonymous function so that we're computing `fix fact' 5` now. `fix` will find a fixed point of `fact'`, i.e. the *function* `f` such that `f == fact' f`. But let's expand what this means:

```
f = fact' f
  = \n -> if n == 0 then 1 else n * f (n-1)
```

All we did was substitute `rec` for `f` in the definition of `fact'`. But this looks exactly like a *recursive* definition of a factorial function! `fix` feeds `fact'` *itself* as its first parameter in order to create a recursive function out of a higher-order function.

We can also consider things from a more operational point of view. Let's actually expand the definition of `fix fact'`:

```
fix fact'
= fact' (fix fact')
= (\rec n -> if n == 0 then 1 else n * rec (n-1)) (fix fact')
= \n -> if n == 0 then 1 else n * fix fact' (n-1)
= \n -> if n == 0 then 1 else n * fact' (fix fact') (n-1)
= \n -> if n == 0 then 1
    else n * (\rec n' -> if n' == 0 then 1 else n' * rec (n'-1)) (fix
fact') (n-1)
= \n -> if n == 0 then 1
    else n * (if n-1 == 0 then 1 else (n-1) * fix fact' (n-2))
= \n -> if n == 0 then 1
    else n * (if n-1 == 0 then 1
        else (n-1) * (if n-2 == 0 then 1
            else (n-2) * fix fact' (n-3)))
= ...
```

Notice that the use of `fix` allows us to keep "unravelling" the definition of `fact'`: every time we hit the `else` clause, we product another copy of `fact'` via the evaluation rule `fix fact'`

= `fact' (fix fact')`, which functions as the next call in the recursion chain. Eventually we hit the `then` clause and bottom out of this chain.

Exercises:

1. Expand the other two examples we gave above in this sense. You may need a lot of paper for the Fibonacci example!
2. Write non-recursive versions of `filter` and `foldr`.

61.4 The typed lambda calculus

In this section we'll expand upon a point mentioned a few times in the previous section: how `fix` allows us to encode recursion in the typed lambda calculus. It presumes you've already met the typed lambda calculus. Recall that in the lambda calculus, there is no `let` clause or top-level bindings. Every program is a simple tree of lambda abstractions, applications and literals. Let's say we want to write a `fact` function. Assuming we have a type called `Nat` for the natural numbers, we'd start out something like the following:

```
λn:Nat. if iszero n then 1 else n * <blank> (n-1)
```

The problem is, how do we fill in the `<blank>`? We don't have a name for our function, so we can't call it recursively. The only way to bind names to terms is to use a lambda abstraction, so let's give that a go:

```
(λf:Nat→Nat. λn:Nat. if iszero n then 1 else n * f (n-1))
  (λm:Nat. if iszero m then 1 else m * <blank> (m-1))
```

This expands to:

```
λn:Nat. if iszero n then 1
  else n * (if iszero n-1 then 1 else (n-1) * <blank> (n-2))
```

We still have a `<blank>`. We could try to add one more layer in:

```
(λf:Nat→Nat. λn:Nat. if iszero n then 1 else n * f (n-1))
  ((λg:Nat→Nat. λm:Nat. if iszero m then 1 else m * g (m-1))
    (λp:Nat. if iszero p then 1 else p * <blank> (p-1))))

->

λn:Nat. if iszero n then 1
  else n * (if iszero n-1 then 1
    else (n-1) * (if iszero n-2 then 1 else (n-2) * <blank>
      (n-3)))
```

It's pretty clear we're never going to be able to get rid of this `<blank>`, no matter how many levels of naming we add in. Never, that is, unless we use `fix`, which, in essence,

provides an object from which we can always unravel one more layer of recursion and still have what we started off:

```
fix (λf:Nat→Nat. λn:Nat. if iszero n then 1 else n * f (n-1))
```

This is a perfect factorial function in the typed lambda calculus plus `fix`.

`fix` is actually slightly more interesting than that in the context of the typed lambda calculus: if we introduce it into the language, then every type becomes inhabited, because given some concrete type `T`, the following expression has type `T`:

```
fix (λx:T. x)
```

This, in Haskell-speak, is `fix id`, which is denotationally \perp . So we see that as soon as we introduce `fix` to the typed lambda calculus, the property that every well-typed term reduces to a value is lost.

61.5 Fix as a data type

It is also possible to make a fix data type in Haskell.

There are three ways of defining it.

```
newtype Fix f = Fix (f (Fix f))
```

or using the `RankNTypes` extension

```
newtype Mu f = Mu (forall a . (f a -> a) -> a)
data Nu f = forall a . Nu a (a -> f a)
```

`Mu` and `Nu` help generalize folds, unfolds and refolds.

```
fold :: (f a -> a) -> Mu f -> a
fold g (Mu f) = f g
unfold :: (a -> f a) -> a -> Nu f
unfold f x = Nu x f
refold :: (a -> f a) -> (g a -> a) -> Mu f -> Nu g
refold f g = unfold g . fold f
```

`Mu` and `Nu` are restricted versions of `Fix`. `Mu` is used for making inductive noninfinite data and `Nu` is used for making coinductive infinite data. Eg)

```
newtype Stream a = Stream (Nu ((,) a)) -- exists b . (b, b -> (a, b))
newtype Void a = Void (Mu ((,) a))    -- forall b . ((a, b) -> b) -> b
```

Unlike the fix point function the fix point types do not lead to bottom. In the following code `Bot` is perfectly defined. It is equivalent to the unit type `()`.

```
newtype Id a = Id a
newtype Bot = Bot (Fix Id) -- equals      newtype Bot=Bot Bot
-- There is only one allowable term. Bot $ Bot $ Bot $ Bot ...
```

The `Fix` data type cannot model all forms of recursion. Take for instance this nonregular data type.

```
data Node a = Two a a | Three a a a
data FingerTree a = U a | Up (FingerTree (Node a))
```

It is not easy to implement this using `Fix`.

62 Haskell Performance

63 Introduction

63.1 Execution Model

63.1.1 Introducing Lazy Evaluation

Programming is not only about writing programs that work but also about programs that require little memory and time to execute on a computer. While both time and memory use are relatively straightforward to predict in an imperative programming language or in *strict* functional languages like LISP or ML, things are different here. In Haskell, expressions are evaluated on demand. For instance, the expression

```
head (map (2 *) [1 .. 10])
```

will be evaluated as follows

```
⇒ head (map (2 *) (1 : [2 .. 10]))    ([1 .. 10])
⇒ head (2 * 1 : map (2 *) [2 .. 10])  (map)
⇒ 2 * 1                               (head)
⇒ 2                                    (*)
```

The function `head` demands only the first element of the list and consequently, the remaining part `map (2 *) [2 .. 10]` of the list is never evaluated. Since this strategy only performs as much evaluation as necessary, it's called **lazy evaluation**. The chapter `../Graph reduction`¹ will present it in detail.

While lazy evaluation is the commonly employed implementation technique for Haskell, the language standard² only specifies that Haskell has **non-strict** denotational semantics³ without fixing a particular execution model. A function `f` with one argument is said to be *strict* if it doesn't terminate or yields an error whenever the evaluation of its argument will loop forever or is otherwise undefined. Writing \perp for the "result" of an infinite loop, the definition for strictness is

A function `f` is called **strict** if `f \perp = \perp` .

For example, trying to add 1 to a number that loops forever will still loop forever, so `\perp +1 = \perp` and the addition function `(+1)` is strict. The function `head` is also strict since the first element of a list won't be available if the whole list is undefined. But it may well be that the first element is well-defined while the remaining list is not. In this case, we have

1 Chapter 65 on page 487
2 <http://www.haskell.org/onlinereport/>
3 Chapter 58 on page 417

```
head (x : ⊥) = x
```

This equation means that `head` does not evaluate the remaining list, otherwise it would loop as well. Thus, such purely algebraic strictness properties are a great help for reasoning about execution time and memory. In strict languages like LISP or ML, we would always have `head (x:⊥) = ⊥`, whereas Haskell being "non-strict" means that we can write functions which are not strict, like the above property of `head` or the simplest example `(const 1) ⊥ = 1`. With the help of the constant `undefined` from the Prelude⁴, we can even explore strictness interactively

```
> head (1 : undefined)
1
> head undefined
*** Exception: Prelude.undefined
```

Strictness and \perp will be used through these chapters. [../Graph reduction/](#)⁵ presents further introductory examples and the denotational point of view is elaborated in [../Denotational semantics/](#)⁶.

63.1.2 Example: fold

The best way to get a first feeling for lazy evaluation is to study an example. Therefore, we will consider some prototypical use case of `foldr` and its variants. The needed basics for studying the time and space complexity of programs are recapped in chapter [../Algorithm complexity/](#)⁷.

Time

Consider the following function `isPrime` that examines whether a number is a prime number or not

```
isPrime n    = not $ any (`divides` n) [2..n-1]
d `divides` n = n `mod` d == 0
any p        = or . map p
or           = foldr (||) False
```

The helper function `any` from the Haskell Prelude⁸ checks whether there is at least one element in the list that satisfies some property `p`. For `isPrime`, the property is "being a divisor of `n`".

The amount of time it takes to evaluate an expression is of course measured by the number of reduction steps. If `n` is a prime number, the above algorithm will examine the full list

4 <http://hackage.haskell.org/packages/archive/base/4.1.0.0/doc/html/Prelude.html>

5 Chapter 65 on page 487

6 Chapter 58 on page 417

7 Chapter 68 on page 513

8 <http://hackage.haskell.org/packages/archive/base/4.1.0.0/doc/html/Prelude.html>

of numbers from 2 to $n-1$ and thus has a worst-case running time of $O(n)$ reductions. However, if n is not a prime number, we do not need to loop through every one of these numbers, we can stop as soon as we found one divisor and report n as being composite. The joy of lazy evaluation is that this behavior is already *built-in* into the logical disjunction `||`!

```
isPrime 42
=> not $ any (`divides` 42) [2..41]
=> not ( or (map (`divides` 42) [2..41]) )
=> not ( or ((42 `mod` 2 == 0) :      map (`divides` 42) [3..41]) )
=> not (      (42 `mod` 2 == 0) || or (map (`divides` 42) [3..41]) )
=> not (              True  || or (map (`divides` 42) [3..41]) )
=> not True
=> False
```

The function returns `False` after seeing that 42 is even, `||` does not look at its second argument when the first one determines the result to be `True`. In other words, we have the following strictness property

```
True || ⊥ = True
```

Of course, the above algorithm can be implemented with a custom loop. But the crux of lazy evaluation is that we could formulate the algorithm in a transparent way by reusing the standard `foldr` and still get early bail-out. Put differently, lazy evaluation is about formulating fast algorithms in a modular way. An extreme example is to use *infinite* data structures to efficiently modularize generate & prune - algorithms. This and many other neat techniques with lazy evaluation will be detailed in the chapter *./Laziness*⁹.

It's neither feasible nor necessary to perform a detailed graph reduction to analyze execution time. Shortcuts are available, like non-strictness or the fact that lazy evaluation will always take fewer reduction steps than eager evaluation. They will be presented in *./Graph reduction*¹⁰.

Space

While execution time is modeled by the number of reduction steps, memory usage is modeled by the size of an expression during evaluation. Unfortunately, it's harder to predict and deviating from the normal course lazy evaluation by more strictness can ameliorate it. More details in *./Graph reduction*¹¹. Here, we will present the prototypical example for unexpected space behavior.

Naively summing a huge number of integers

```
> foldr (+) 0 [1..1000000]
*** Exception: stack overflow
```

9 Chapter 66 on page 499

10 Chapter 65 on page 487

11 Chapter 65 on page 487

produces a stack overflow. What happens? The evaluation proceeds as follows

```
foldr (+) 0 [1..1000000]
  => 1+(foldr (+) 0 [2..1000000])
  => 1+(2+(foldr (+) 0 [3..1000000]))
  => 1+(2+(3+(foldr (+) 0 [4..1000000])))
```

and so on. We see that the expression grows larger and larger, needing more and more memory. In this case, the memory is allocated on the stack for performing the pending additions after the recursive calls to `foldr` return. At some point, the memory needed exceeds the maximum possible stack size raising the "stack overflow" error. Don't worry whether it's stack or heap, the thing to keep in mind is that the size of the expression corresponds to the memory used and we see that in general, evaluating `foldr (+) 0 [1..n]` needs $O(n)$ memory.

But it should be possible to do it in $O(1)$ space by keeping an accumulated sum of numbers seen so far, exploiting that `+` is associative. (Some readers may notice that this means to make the function tail recursive.) This is what `foldl` does:

```
foldl (+) 0 [1..n]
  => foldl (+) (0+1) [2..n]
  => foldl (+) ((0+1)+2) [3..n]
  => foldl (+) (((0+1)+2)+3) [4..n]
```

But much to our horror, the accumulated sum will not be reduced any further! It will grow on the heap until the end of the list is reached

```
=> ... => foldl (+) (((((0+1)+2)+3)+...)) []
=> (((((0+1)+2)+3)+...))
```

and subsequent reduction of this huge unevaluated sum will fail with a stack overflow, too. (So, just introducing an accumulating parameter doesn't make it tail recursive.)

The problem is that the unevaluated sum is an overly large representation for a single integer and it's cheaper to evaluate it eagerly. This is what `foldl'` does:

```
foldl' f z [] = z
foldl' f z (x:xs) = z `seq` foldl' f (f z x) xs
```

Here, evaluating `a `seq` b` will reduce `a` to weak head normal form¹² before proceeding with the reduction of `b`. With this, the sum proceeds as

```
foldl' (+) 0 [1..n]
  => foldl' (+) (0+1) [2..n]
  => foldl' (+) (1+2) [3..n]
  => foldl' (+) (3+3) [4..n]
```

¹² Chapter 65.3.7 on page 493

```
⇒ foldl' (+) (6+4) [5..n]
⇒ ...
```

in constant space.

For more details and examples, read the chapter [./Graph reduction](#)¹³.

63.1.3 Low-level Overhead

Compared to eager evaluation, lazy evaluation adds a considerable overhead, even integers or characters have to be stored as pointers since they might be \perp . An array of 1-byte characters is several times more compact than a `String = [Char]` of similar length. With strictness annotations, unboxed types and automatic strictness analysis, the overhead can be reduced. The Haskell wiki is a good resource <http://www.haskell.org/haskellwiki/Performance> concerning these low-level details, the wikibook currently doesn't cover them.

63.2 Algorithms & Data Structures

63.2.1 Algorithms

While this wikibook is not a general book on algorithms, there are many techniques of writing efficient programs unique to functional programming. The chapter [./Algorithm complexity](#)¹⁴ recaps the big-O notation and presents a few examples from practice.

In [./Laziness](#)¹⁵, the focus is on exploiting lazy evaluation to write efficient algorithms in a modular way.

A common theme of [./Program derivation](#)¹⁶ and [./Equational reasoning](#)¹⁷ is to derive an efficient program from a specification by applying and proving equations like

```
map f . reverse = reverse . map f
filter p . map f = map f . filter (p . f)
```

This quest has given rise to a gemstone, namely a purely algebraic approach to dynamic programming which will be introduced in *some chapter with a good name*.

Another equational technique known as **fusion** or **deforestation** aims to remove intermediate data structures in function compositions. For instance, the composition on the left hand side of

```
map f . map g = map (f . g)
```

¹³ Chapter 65 on page 487

¹⁴ Chapter 68 on page 513

¹⁵ Chapter 66 on page 499

¹⁶ <https://en.wikibooks.org/wiki/./%2FProgram%20derivation%2F>

¹⁷ <https://en.wikibooks.org/wiki/./%2FEquational%20reasoning%2F>

constructs and deconstructs an intermediate list whereas the right hand side is a single pass over the list. The general theme here is to fuse constructor-destructor pairs like

```
case (Just y) of { Just x -> f x; Nothing -> ...; } = f y
```

This will be detailed in *some chapter with a good name*.

63.2.2 Data structures

Choosing the right data structure is key to success. While lists are common and can lead surprisingly far, they are more a kind of materialized loops than a classical data structure with fast access and updates. Many languages have special support for particular data structures of that kind like arrays in C, hash tables in Perl or lists in LISP. Natively, Haskell favors any kind of tree. But thanks to parametric polymorphism and type classes, any abstract type like balanced binary trees is easy to use and reuse! The chapter *./Data structures*¹⁸ details the natural choices of data structures for common problems.

Because Haskell is purely functional, data structures share the common trait of being **persistent**. This means that older version of a data structure are still available like in

```
foo set = (newset, set)
  where newset = insert "bar" set
```

Compared to that, the default in imperative languages is **ephemeral**, i.e. data is updated in place and old versions are overridden. For example, arrays are ephemeral. That's why they are either immutable or require monads to use in Haskell. Fortunately, many ephemeral structures like queues or heaps have persistent counterparts and the chapter *./Data structures*¹⁹ will also gently introduce some design principles in that direction, for instance concerning amortization.

63.3 Parallelism

The goal of parallelism is to run an algorithm on multiple cores / computers in parallel for faster results. Because Haskell doesn't impose an execution order thanks to its purity, it is well-suited for formulating parallel algorithms.

Currently, parallelism in Haskell is still a research topic and subject to experimentation. There are combinators for controlling the execution order *Control.Parallel.Strategies*²⁰, but they are rather fine-grained. Research on a less ambitious but more practical alternative *Data Parallel Haskell*²¹ is ongoing.

18 <https://en.wikibooks.org/wiki/./Data%20structures%2F>

19 <https://en.wikibooks.org/wiki/./Data%20structures%2F>

20 <http://hackage.haskell.org/packages/archive/parallel/1.0.0.0/doc/html/Control-Parallel-Strategies.html>

21 http://haskell.org/haskellwiki/GHC/Data_Parallel_Haskell

The chapter `../Parallelism/`²² is not yet written but is intended to be a gentle introduction to parallel algorithms and current possibilities in Haskell.

²² <https://en.wikibooks.org/wiki/..%2FParallelism%2F>

64 Step by Step Examples

Goal: Explain optimizations step by step with examples that actually happened.

64.1 Tight loop

dons: Write Haskell as fast as C: exploiting strictness, laziness and recursion.¹ << DEAD LINK

dons: Write Haskell as fast as C: exploiting strictness, laziness and recursion.²

64.2 CSV Parsing

haskell-cafe: another Newbie performance question³ I hope he doesn't mind if I post his code here, I still have to ask him. -- apfelmus⁴ 08:46, 18 May 2008 (UTC)

```
type CSV = [[String]]

main = do
    args <- getArgs
    file <- readFile (head args)
    writeFile (head args ++ ".csv") (processFile (args !! 1) file)

processFile s = writeCSV . doInteraction s . readCSV
doInteraction line csv = insertLine (show line) (length csv - 1) csv
writeCSV = (\x -> x ++ "\n") . concat . intersperse "\n" . (map (concat
    . intersperse ",") . (map show))
insertLine line pos csv = (take pos csv) ++ [readCSVLine line] ++ drop pos csv
readCSVLine = read . (\x -> "[" ++ x ++ "]")
readCSV = map readCSVLine . lines
```

I think there was another cvs parsing thread on the mailing list which I deemed appropriate, but I can't remember.

64.3 Space Leak

jkff asked about some code in #haskell which was analyzing a logfile. Basically, it was building a histogram

1 <http://cgi.cse.unsw.edu.au/~dons/blog/2008/05/16#fast>
2 <http://donsbot.wordpress.com/2008/05/06/write-haskell-as-fast-as-c-exploiting-strictness-laziness-and-recursion/#fast>
3 <http://thread.gmane.org/gmane.comp.lang.haskell.cafe/40114>
4 <https://en.wikibooks.org/wiki/User%3AApfelmus>

```
foldl' (\m (x,y) -> insertWith' x (\[y] ys -> y:ys) [y] m) M.empty
  [(ByteString.copy foo, ByteString.copy bar) | (foo,bar) <- map (match regex)
  lines]
```

The input was a 1GB logfile and the program blew the available memory mainly because the `ByteString.copy` weren't forced and the whole file lingered around in memory.

65 Graph reduction

65.1 Notes and TODOs

- *TODO: Pour lazy evaluation explanation from ../Laziness/¹ into this mold.*
- *TODO: better section names.*
- *TODO: ponder the graphical representation of graphs.*
 - *No graphical representation, do it with `let .. in`. Pro: Reduction are easiest to perform in that way anyway. Cons: no graphic.*
 - *ASCII art / line art similar to the one in Bird&Wadler? Pro: displays only the relevant parts truly as graph, easy to perform on paper. Cons: Ugly, no large graphs with that.*
 - *Full blown graphs with @-nodes? Pro: look graphy. Cons: nobody needs to know @-nodes in order to understand graph reduction. Can be explained in the implementation section.*
 - *Graphs without @-nodes. Pro: easy to understand. Cons: what about currying?*
- *! Keep this chapter short. The sooner the reader knows how to evaluate Haskell programs by hand, the better.*
- *First sections closely follow Bird&Wadler*

65.2 Introduction

Programming is not only about writing correct programs, answered by denotational semantics, but also about writing fast ones that require little memory. For that, we need to know how they're executed on a machine, commonly given by operational semantics. This chapter explains how Haskell programs are commonly executed on a real computer and thus serves as foundation for analyzing time and space usage. Note that the Haskell standard deliberately does *not* give operational semantics, implementations are free to choose their own. But so far, every implementation of Haskell more or less closely follows the execution model of *lazy evaluation*.

In the following, we will detail lazy evaluation and subsequently use this execution model to explain and exemplify the reasoning about time and memory complexity of Haskell programs.

¹ Chapter 66 on page 499

65.3 Evaluating Expressions by Lazy Evaluation

65.3.1 Reductions

Executing a functional program, i.e. evaluating an expression, means to repeatedly apply function definitions until all function applications have been expanded. Take for example the expression `pythagoras 3 4` together with the definitions

```
square x = x * x
pythagoras x y = square x + square y
```

One possible sequence of such **reductions** is

```
pythagoras 3 4
⇒ square 3 + square 4 (pythagoras)
⇒ (3*3) + square 4 (square)
⇒ 9 + square 4 (*)
⇒ 9 + (4*4) (square)
⇒ 9 + 16 (*)
⇒ 25
```

Every reduction replaces a subexpression, called **reducible expression** or **redex** for short, with an equivalent one, either by appealing to a function definition like for `square` or by using a built-in function like `(+)`. An expression without redexes is said to be in **normal form**. Of course, execution stops once reaching a normal form which thus is the result of the computation.

Clearly, the fewer reductions that have to be performed, the faster the program runs. We cannot expect each reduction step to take the same amount of time because its implementation on real hardware looks very different, but in terms of asymptotic complexity, this number of reductions is an accurate measure.

65.3.2 Reduction Strategies

There are many possible reduction sequences and the number of reductions may depend on the order in which reductions are performed. Take for example the expression `fst (square 3, square 4)`. One systematic possibility is to evaluate all function arguments before applying the function definition

```
fst (square 3, square 4)
⇒ fst (3*3, square 4) (square)
⇒ fst ( 9 , square 4) (*)
⇒ fst ( 9 , 4*4) (square)
⇒ fst ( 9 , 16 ) (*)
⇒ 9 (fst)
```

This is called an **innermost reduction** strategy and an **innermost redex** is a redex that has no other redex as subexpression inside.

Another systematic possibility is to apply all function definitions first and only then evaluate arguments:

```
fst (square 3, square 4)
  ⇒ square 3           (fst)
  ⇒ 3*3                (square)
  ⇒ 9                  (*)
```

which is named **outermost reduction** and always reduces **outermost redexes** that are not inside another redex. Here, the outermost reduction uses fewer reduction steps than the innermost reduction. Why? Because the function `fst` doesn't need the second component of the pair and the reduction of `square 4` was superfluous.

65.3.3 Termination

For some expressions like

```
loop = 1 + loop
```

no reduction sequence may terminate and program execution enters a neverending loop, those expressions do not have a normal form. But there are also expressions where some reduction sequences terminate and some do not, an example being

```
fst (42, loop)
  ⇒ 42                (fst)

fst (42, loop)
  ⇒ fst (42,1+loop)   (loop)
  ⇒ fst (42,1+(1+loop)) (loop)
  ⇒ ...
```

The first reduction sequence is outermost reduction and the second is innermost reduction which tries in vain to evaluate the `loop` even though it is ignored by `fst` anyway. The ability to evaluate function arguments only when needed is what makes outermost optimal when it comes to termination:

Theorem (Church Rosser II)

If there is one terminating reduction, then outermost reduction will terminate, too.

65.3.4 Graph Reduction (Reduction + Sharing)

Despite the ability to discard arguments, outermost reduction doesn't always take fewer reduction steps than innermost reduction:

```
square (1+2)
  ⇒ (1+2)*(1+2)      (square)
  ⇒ (1+2)*3          (+)
```

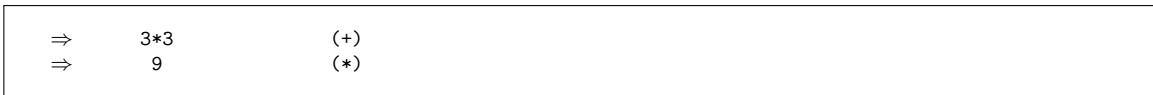

Here, the argument $(1+2)$ is duplicated and subsequently reduced twice. But because it is one and the same argument, the solution is to share the reduction $(1+2) \Rightarrow 3$ with all other incarnations of this argument. This can be achieved by representing expressions as *graphs*. For example,



represents the expression $(1+2)*(1+2)$. Now, the **outermost graph reduction** of square $(1+2)$ proceeds as follows



and the work has been shared. In other words, outermost graph reduction now reduces every argument at most once. For this reason, it always takes fewer reduction steps than the innermost reduction, a fact we will prove when reasoning about time².

Sharing of expressions is also introduced with `let` and `where` constructs. For instance, consider Heron's formula³ for the area of a triangle with sides a, b and c :

<pre style="margin: 0;">area a b c = let s = (a+b+c)/2 in sqrt (s*(s-a)*(s-b)*(s-c))</pre>

Instantiating this to an equilateral triangle will reduce as

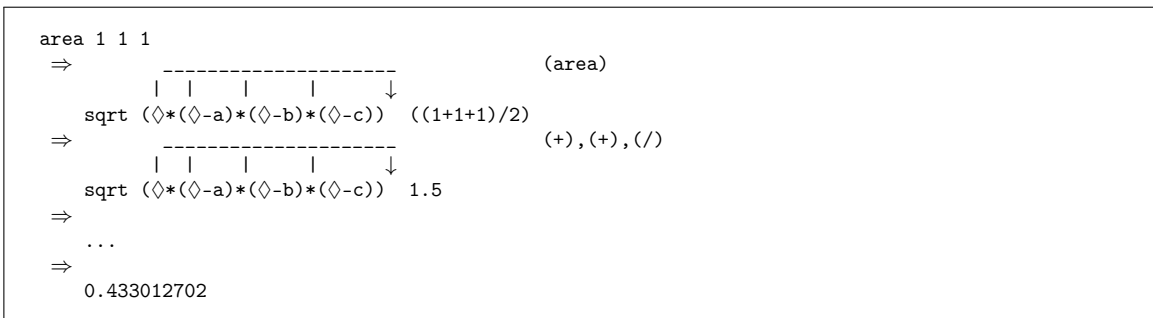

² Chapter 65.5 on page 496
³ <https://en.wikipedia.org/wiki/Heron%27s%20formula>

which is $\sqrt{3}/4$. Put differently, `let`-bindings simply give names to nodes in the graph. In fact, one can dispense entirely with a graphical notation and solely rely on `let` to mark sharing and express a graph structure.⁴

Any implementation of Haskell is in some form based on outermost graph reduction which thus provides a good model for reasoning about the asymptotic complexity of time and memory allocation. The number of reduction steps to reach normal form corresponds to the execution time and the size of the terms in the graph corresponds to the memory used.

Exercises:

1. Reduce `square (square 3)` to normal form with innermost and outermost graph reduction.
2. Consider the fast exponentiation algorithm

```
power x 0 = 1
power x n = x' * x' * (if n `mod` 2 == 0 then 1 else x)
  where x' = power x (n `div` 2)
```

that takes `x` to the power of `n`. Reduce `power 2 5` with innermost and outermost graph reduction. How many reductions are performed? What is the asymptotic time complexity for the general `power 2 n`? What happens to the algorithm if we use "graphless" outermost reduction?

65.3.5 Pattern Matching

So far, our description of outermost graph reduction is still underspecified when it comes to pattern matching and data constructors. Explaining these points will enable the reader to trace most cases of the reduction strategy that is commonly the base for implementing non-strict functional languages like Haskell. It is called **call-by-need** or **lazy evaluation** in allusion to the fact that it "lazily" postpones the reduction of function arguments to the last possible moment. Of course, the remaining details are covered in subsequent chapters.

To see how pattern matching needs specification, consider for example the boolean disjunction

```
or True y = True
or False y = y
```

and the expression

⁴ John Maraist, Martin Odersky, and Philip Wadler . The call-by-need lambda calculus The call-by-need lambda calculus ^{{homepages.inf.ed.ac.uk/wadler/topics/call-{}by-{}need.html#need-{}journal}} . *Journal of Functional Programming* , 8 : 257-317 May 1998 <http://homepages.inf.ed.ac.uk/wadler/topics/call-by-need.html#need-journal>

```
or (1==1) loop
```

with a non-terminating loop = not loop. The following reduction sequence

```
or (1==1) loop
⇒ or (1==1) (not loop)      (loop)
⇒ or (1==1) (not (not loop)) (loop)
⇒ ...
```

only reduces outermost redexes and therefore is an outermost reduction. But

```
or (1==1) loop
⇒ or True  loop      (or)
⇒ True
```

makes much more sense. Of course, we just want to apply the definition of `or` and are only reducing arguments to decide which equation to choose. This intention is captured by the following rules for pattern matching in Haskell:

- Left hand sides are matched from top to bottom
- When matching a left hand side, arguments are matched from left to right
- Evaluate arguments only as much as needed to decide whether they match or not.

Thus, for our example `or (1==1) loop`, we have to reduce the first argument to either `True` or `False`, then evaluate the second to match a variable `y` pattern and then expand the matching function definition. As the match against a variable always succeeds, the second argument will not be reduced at all. It is the second reduction section above that reproduces this behavior.

With these preparations, the reader should now be able to evaluate most Haskell expressions. Here are some random encounters to test this ability:

Exercises:

Reduce the following expressions with lazy evaluation to normal form. Assume the standard function definitions from the Prelude.

- `length [42,42+1,42-1]`
- `head (map (2*) [1,2,3])`
- `head $ [1,2,3] ++ (let loop = tail loop in loop)`
- `zip [1..3] (iterate (+1) 0)`
- `head $ concatMap (\x -> [x,x+1]) [1,2,3]`
- `take (42-6*7) $ map square [2718..3146]`

65.3.6 Higher Order Functions

The remaining point to clarify is the reduction of higher order functions and currying. For instance, consider the definitions

```
id x = x
a = id (+1) 41
```

```
twice f = f . f
b = twice (+1) (13*3)
```

where both `id` and `twice` are only defined with one argument. The solution is to see multiple arguments as subsequent applications to one argument, this is called **currying**

```
a = (id (+1)) 41
b = (twice (+1)) (13*3)
```

To reduce an arbitrary application $expression_1\ expression_2$, call-by-need first reduce $expression_1$ until this becomes a function whose definition can be unfolded with the argument $expression_2$. Hence, the reduction sequences are

```
a
⇒ (id (+1)) 41      (a)
⇒ (+1) 41          (id)
⇒ 42                (+)

b
⇒ (twice (+1)) (13*3) (b)
⇒ ((+1).(+1)) (13*3) (twice)
⇒ (+1) ((+1) (13*3)) (.)
⇒ (+1) ((+1) 39)    (*)
⇒ (+1) 40           (+)
⇒ 41                (+)
```

Admittedly, the description is a bit vague and the next section will detail a way to state it clearly.

While it may seem that pattern matching is the workhorse of time intensive computations and higher order functions are only for capturing the essence of an algorithm, functions are indeed useful as data structures. One example are difference lists (`[a] -> [a]`) that permit concatenation in $O(1)$ time, another is the representation of a stream by a fold. In fact, all data structures are represented as functions in the pure lambda calculus, the root of all functional programming languages.

Exercises! Or not? Diff-Lists Best done with `foldl (++)` but this requires knowledge of the fold example. Oh, where do we introduce the `foldl` VS. `foldr` example at all? Hm, Bird&Wadler sneak in an extra section "Meet again with fold" for the `++` example at the end of "Controlling reduction order and space requirements" :-/ The complexity of `++` is explained when arguing about `reverse`.

65.3.7 Weak Head Normal Form

To formulate precisely how lazy evaluation chooses its reduction sequence, it is best to abandon equational function definitions and replace them with an expression-oriented approach. In other words, our goal is to translate function definitions like `f (x:xs) = ...` into the

form $f = \textit{expression}$. This can be done with two primitives, namely case-expressions and lambda abstractions.

In their primitive form, case-expressions only allow the discrimination of the outermost constructor. For instance, the primitive case-expression for lists has the form

```
case expression of
[] -> ...
x:xs -> ...
```

Lambda abstractions are functions of one parameter, so that the following two definitions are equivalent

```
f x = expression
f = \x -> expression
```

Here is a translation of the definition of `zip`

```
zip :: [a] -> [a] -> [(a,a)]
zip [] ys = []
zip xs [] = []
zip (x:xs') (y:ys') = (x,y):zip xs' ys'
```

to case-expressions and lambda-abstractions:

```
zip = \xs -> \ys ->
  case xs of
  [] -> []
  x:xs' ->
    case ys of
    [] -> []
    y:ys' -> (x,y):zip xs' ys'
```

Assuming that all definitions have been translated to those primitives, every redex now has the form of either

- a function application $(\backslash \textit{variable} \rightarrow \textit{expression}_1) \textit{expression}_2$
- or a case-expression `case expression of { ... }`

lazy evaluation.

Weak Head Normal Form

An expression is in weak head normal form, iff it is either

- a constructor (possibly applied to arguments) like `True`, `Just` (square 42) or `(:)` 1
- a built-in function applied to too few arguments (perhaps none) like `(+)` 2 or `sqrt`.
- or a lambda abstraction $\backslash x \rightarrow \textit{expression}$.

functions types cannot be pattern matched anyway, but the devious seq can evaluate them to WHNF nonetheless. "weak" = no reduction under lambdas. "head" = first the function application, then the arguments.

65.3.8 Strict and Non-strict Functions

A non-strict function doesn't need its argument. A strict function needs its argument in WHNF, as long as we do not distinguish between different forms of non-termination ($f\ x = \text{loop}$ doesn't need its argument, for example).

65.4 Controlling Space

"Space" here may be better visualized as traversal of a graph. Either a data structure, or an induced dependencies graph. For instance : Fibonacci(N) depends on : Nothing if $N = 0$ or $N = 1$; Fibonacci(N-1) and Fibonacci(N-2) else. As Fibonacci(N-1) depends on Fibonacci(N-2), the induced graph is not a tree. Therefore, there is a correspondence between implementation technique and data structure traversal :

Corresponding Implementation technique	Data Structure Traversal
Memoization	Depth First Search (keep every intermediary result in memory)
Parallel evaluation	Breadth First Search (keep every intermediary result in memory, too)
Sharing	Directed acyclic graph traversal (Maintain only a "frontier" in memory.)
Usual recursion	Tree traversal (Fill a stack)
Tail recursion	List traversal / Greedy Search (Constant space)

The classical :

```

fib0 0 = 1
fib0 1 = 1
fib0 n = fib0 (n-1) + fib0 (n-2)

```

Is a tree traversal applied to a directed acyclic graph for the worse. The optimized version :

```

fib0 n =
  let f a b m =
    if m = 0 then a
    if m = 1 then b
    f b (a+b) (m-1)
  in f 1 1 n

```

Uses a DAG traversal. Luckily, the frontier size is constant, so it's a tail recursive algorithm.

NOTE: The chapter [../Strictness⁵](#) is intended to elaborate on the stuff here.

NOTE: The notion of strict function is to be introduced before this section.

Now's the time for the space-eating fold example:

```
foldl (+) 0 [1..10]
```

Introduce `seq` and `$!` that can force an expression to WHNF. \Rightarrow `foldl'`.

Tricky space leak example:

```
(\xs -> head xs + last xs) [1..n]  
(\xs -> last xs + head xs) [1..n]
```

The first version runs on $O(1)$ space. The second in $O(n)$.

65.4.1 Sharing and CSE

NOTE: overlaps with section about time. Hm, make an extra memoization section?

How to share

```
foo x y = -- s is not shared  
foo x = \y -> s + y  
  where s = expensive x -- s is shared
```

"Lambda-lifting", "Full laziness". The compiler should not do full laziness.

A classic and important example for the trade between space and time:

```
sublists [] = 6  
sublists (x:xs) = sublists xs ++ map (x:) (sublists xs)  
sublists' (x:xs) = let ys = sublists' xs in ys ++ map (x:) ys
```

That's why the compiler should not do common subexpression elimination as optimization. (Does GHC?).

65.4.2 Tail recursion

NOTE: Does this belong to the space section? I think so, it's about stack space.

Tail recursion in Haskell looks different.

65.5 Reasoning about Time

Note: introducing strictness before the upper time bound saves some hassle with explanation?

65.5.1 Lazy eval < Eager eval

When reasoning about execution time, naively performing graph reduction by hand to get a clue on what's going on is most often infeasible. In fact, the order of evaluation taken by lazy evaluation is difficult to predict by humans, it is much easier to trace the path of eager evaluation where arguments are reduced to normal form before being supplied to a function. But knowing that lazy evaluation always performs fewer reduction steps than eager evaluation (present the proof!), we can easily get an upper bound for the number of reductions by pretending that our function is evaluated eagerly.

Example:

```
or = foldr (||) False
isPrime n = not $ or $ map (\k -> n `mod` k == 0) [2..n-1]
```

=> eager evaluation always takes n steps, lazy won't take more than that. But it will actually take fewer.

65.5.2 Throwing away arguments

Time bound exact for functions that examine their argument to normal form anyway. The property that a function needs its argument can concisely be captured by denotational semantics:

```
f ⊥ = ⊥
```

Argument in WHNF only, though. Operationally: non-termination \rightarrow non-termination. (this is an approximation only, though because $f \text{ anything} = \perp$ doesn't "need" its argument). Non-strict functions don't need their argument and eager time bound is not sharp. But the information whether a function is strict or not can already be used to great benefit in the analysis.

```
isPrime n = not $ or $ (n `mod` 2 == 0) : (n `mod` 3 == 0) : ...
```

It's enough to know $\text{or True } \perp = \text{True}$.

Other examples:

- `foldr (:) []` vs. `foldl (flip (:)) []` with \perp .
- Can `head . mergesort` be analyzed only with \perp ? In any case, this example is too involved and belongs to *../Laziness*⁷.

⁷ Chapter 66 on page 499

65.5.3 Persistence & Amortisation

NOTE: this section is better left to a data structures chapter because the subsections above cover most of the cases a programmer not focussing on data structures / amortization will encounter.

Persistence = no updates in place, older versions are still there. Amortisation = distribute unequal running times across a sequence of operations. Both don't go well together in a strict setting. Lazy evaluation can reconcile them. Debit invariants. Example: incrementing numbers in binary representation.

65.6 Implementation of Graph reduction

Small talk about G-machines and such. Main definition:

closure = thunk = code/data pair on the heap. What do they do? Consider $(\lambda x.\lambda y.x + y)2$. This is a function that returns a function, namely $\lambda y.2 + y$ in this case. But when you want to compile code, it's prohibitive to actually perform the substitution in memory and replace all occurrences of x by 2. So, you return a closure that consists of the function code $\lambda y.x + y$ and an environment $\{x = 2\}$ that assigns values to the free variables appearing in there.

GHC (and most Haskell implementations) avoid free variables completely and use super-combinators. In other words, they're supplied as extra-parameters and the observation that lambda-expressions with too few parameters don't need to be reduced since their WHNF is not very different.

Note that these terms are technical terms for implementation stuff, lazy evaluation happily lives without them. Don't use them in any of the sections above.

65.7 References

- Introduction to Functional Programming using Haskell . Prentice Hall , , 1998
- The Implementation of Functional Programming Languages . Prentice Hall , , 1987

66 Laziness

Quote:

Hard work pays off later. Laziness pays off now! – Steven Wright

66.1 Introduction

By now, you are aware that Haskell uses lazy evaluation in that nothing is evaluated until necessary. But what exactly does "until necessary" mean? In this chapter, we will see how lazy evaluation works (how little black magic there is), what exactly it means for functional programming, and how to make the best use of it.

First, let's consider the reasons and implications of lazy evaluation. At first glance, we might think that lazy evaluation makes programs more efficient. After all, what can be more efficient than not doing anything? In practice, however, laziness often introduces an overhead that leads programmers to hunt for places where they can make their code more strict. The real benefit of laziness is in making the right things **efficient enough**. *Lazy evaluation allows us to write more simple, elegant code than we could in a strict environment.*

66.1.1 Nonstrictness versus Laziness

There is a slight difference between *laziness* and *nonstrictness*. **Nonstrict semantics** refers to a given property of Haskell programs that you can rely on: nothing will be evaluated until it is needed. **Lazy evaluation** is how you implement nonstrictness using a device called **thunks** which we explain in the next section. However, these two concepts are so closely linked that it helps to explain them both together. Knowledge of thunks helps in understanding nonstrictness, and the semantics of nonstrictness explains why we use lazy evaluation in the first place. So, we'll introduce the concepts simultaneously and make no particular effort to keep them from intertwining (with the exception of getting the terminology right).

66.2 Thunks and Weak head normal form

You need to understand two principles to see how programs execute in Haskell. First, we have the property of nonstrictness: we evaluate as little as possible and delay evaluation as long as possible. Second, Haskell values are highly layered; and 'evaluating' a Haskell value could mean evaluating down to any one of these layers. Let's walk through a few examples using a pair.

```
let (x, y) = (length [1..5], reverse "olleh") in ...
```

Assume that in the 'in' part, we use `x` and `y` somewhere — otherwise, we wouldn't need to evaluate the let-binding at all! The right-hand side could have been `undefined`, and it would still work if the 'in' part doesn't mention `x` or `y`. This assumption will remain for all the examples in this section.

What do we know about `x`? We can calculate that `x` must be 5 and `y` is "hello", but remember the first principle: we don't evaluate the calls to `length` and `reverse` until we're forced to. So, we say that `x` and `y` are both **thunks**: that is, they are *unevaluated values* with a *recipe* that explains how to evaluate them. For example, for `x` this recipe says 'Evaluate `length [1..5]`'. However, we are actually doing some pattern matching on the left hand side. What would happen if we removed that?

```
let z = (length [1..5], reverse "olleh") in ...
```

Although it's still pretty obvious to us that `z` is a pair, the compiler sees that we're not trying to deconstruct the value on the right-hand side of the '=' sign at all, so it doesn't really care what's there. It lets `z` be a thunk on its own. Later on, when we try to use `z`, we'll probably need one or both of the components, so we'll have to evaluate `z`, but for now, it can be a thunk.

Above, we said Haskell values were layered. We can see that it works if we pattern match on `z`:

```
let z      = (length [1..5], reverse "olleh")
    (n, s) = z
in ...
```

After the first line has been executed, `z` is simply a thunk. We know nothing about the sort of value it is because we haven't been asked to find out yet. In the second line, however, we pattern match on `z` using a pair pattern. The compiler thinks 'I better make sure that pattern does indeed match `z`, and in order to do that, I need to make sure `z` is a pair.' Be careful, though — we're not yet doing anything with the component parts (the calls to `length` and `reverse`), so they can remain unevaluated. In other words, `z`, which was just a thunk, gets evaluated to something like `(*thunk*, *thunk*)`, and `n` and `s` become thunks which, when evaluated, will be the component parts of the original `z`.

Let's try a slightly more complicated pattern match:

```
let z      = (length [1..5], reverse "olleh")
    (n, s) = z
    'h':ss = s
in ...
```

The pattern match on the second component of `z` causes some evaluation. The compiler wishes to check that the `'h':ss` pattern matches the second component of the pair. So, it:

1. Evaluates the top level of `s` to ensure it's a cons cell: `s = *thunk* : *thunk*`. (If `s` had been an empty list we would encounter a pattern match failure error at this point.)
 2. Evaluates the first thunk it just revealed to make sure it's `'h':ss = 'h' : *thunk*`
- The rest of the list stays unevaluated, and `ss` becomes a thunk which, when evaluated, will be the rest of this list.

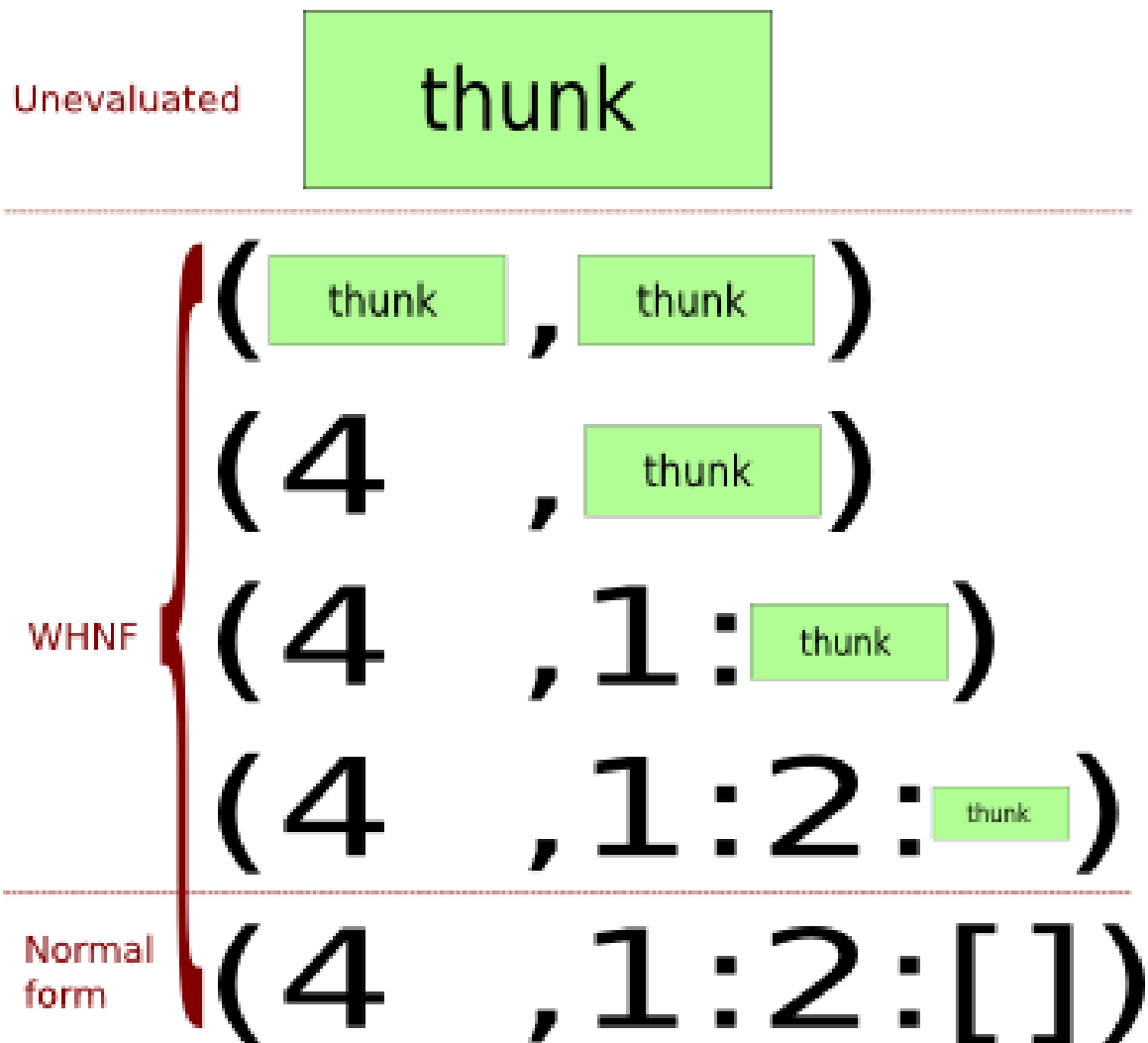

Figure 35 Evaluating the value $(4, [1, 2])$ step by step. The first stage is completely unevaluated; all subsequent forms are in WHNF, and the last one is also in normal form.

We can 'partially evaluate' (most) Haskell values. Also, there is some sense of the minimum amount of evaluation we can do. For example, if we have a pair `thunk`, then the minimum amount of evaluation takes us to the pair constructor with two unevaluated components: `(*thunk*, *thunk*)`. If we have a list, the minimum amount of evaluation takes us either to a cons cell `*thunk* : *thunk*` or an empty list `[]`. Note that in the empty list case, no more evaluation can be performed on the value; it is said to be in **normal form**. If we are at any of the intermediate steps so that we've performed at least some evaluation on a value, it is in **weak head normal form** (WHNF). (There is also a 'head normal form', but it's not used in Haskell.) *Fully* evaluating something in WHNF reduces it to something in normal form; if at some point we needed to, say, print `z` out to the user, we'd need to fully evaluate it, including those calls to `length` and `reverse`, to `(5, "hello")`, where it is in normal form. Performing any degree of evaluation on a value is sometimes called **forcing** that value.

Note that for some values there is only one result. For example, you can't partially evaluate an integer. It's either a thunk or it's in normal form. Furthermore, if we have a constructor with strict components (annotated with an exclamation mark, as with `data MaybeS a = NothingS | JustS !a`), these components become evaluated as soon as we evaluate the level above. I.e. we can never have `JustS *thunk*` — as soon as we get to this level, the strictness annotation on the component of `JustS` forces us to evaluate the component part.

In this section we've explored the basics of laziness. We've seen that nothing gets evaluated until it is needed (in fact, the *only* place that Haskell values get evaluated is in pattern matches and inside certain primitive IO functions). This principle even applies to evaluating values — we do the minimum amount of work on a value that we need to compute our result.

66.3 Lazy and strict functions

Functions can be lazy or strict 'in an argument'. Most functions need to do something with their arguments, and this will involve evaluating these arguments to different levels. For example, `length` needs to evaluate only the cons cells in the argument you give it, not the contents of those cons cells. `length *thunk*` might evaluate to something like `length (*thunk* : *thunk* : *thunk* : [])`, which in turn evaluates to 3. Others need to evaluate their arguments fully, as in `(length . show)`. If you had `length $ show *thunk*`, there's no way you can do anything other than evaluate that thunk to normal form.

So, some functions evaluate their arguments more fully than others. Given two functions of one parameter, `f` and `g`, we say `f` is stricter than `g` if `f x` evaluates `x` to a deeper level than `g x`. Often, we only care about WHNF, so a function that evaluates its argument to at least WHNF is called *strict* and one that performs no evaluation is *lazy*. What about functions of more than one parameter? Well, we can talk about functions being strict in one parameter, but lazy in another. For example, given a function like the following:

```
f x y = length $ show x
```

Clearly we need to perform no evaluation on `y`, but we need to evaluate `x` fully to normal form, so `f` is strict in its first parameter but lazy in its second.

Exercises:

1. Why must we fully evaluate `x` to normal form in `f x y = show x`?
2. Which is the stricter function?

```
f x = length [head x]
g x = length (tail x)
```

In the original discussion about Folds¹, we discussed memory problems with `foldl` that are solved by the strictly-evaluated `foldl'`. Essentially, `foldr` `(:)` `[]` and `foldl` `(flip (:))` `[]` both evaluate their arguments to the same level of strictness, but `foldr` can start

¹ <https://en.wikibooks.org/wiki/Haskell%2FList%20processing%23foldl>

producing values straight away, whereas `foldl` needs to evaluate cons cells all the way to the end before it starts producing any output. So, there are times when strictness can be valuable.

66.3.1 Black-box strictness analysis

Strict function



Lazy function



Figure 36 If `f` returns an error when passed `undefined`, it must be strict. Otherwise, it's lazy.

Imagine we're given some function `f` which takes a single parameter. We're not allowed to look at its source code, but we want to know whether `f` is strict or not. How might we do this? Probably the easiest way is to use the standard Prelude value `undefined`. Forcing `undefined` to any level of evaluation will halt our program and print an error, so all of these print errors:

```
let (x, y) = undefined in x
length undefined
head undefined
JustS undefined -- Using MaybeS as defined in the last section
```

So if a function is strict, passing it `undefined` will result in an error. Were the function lazy, passing it `undefined` would print no error and we can carry on as normal. For example, none of the following produce errors:

```
let (x, y) = (4, undefined) in x
length [undefined, undefined, undefined]
head (4 : undefined)
Just undefined
```

So we can say that `f` is a strict function if, and only if, `f undefined` results in an error being printed and the halting of our program.

66.3.2 In the context of nonstrict semantics

What we've presented so far makes sense until you start to think about functions like `id`. Is `id` strict? Our gut reaction is probably to say "No! It doesn't evaluate its argument, therefore it's lazy". However, let's apply our black-box strictness analysis from the last section to `id`. Clearly, `id undefined` is going to print an error and halt our program, so shouldn't we say that `id` is strict? The reason for this mixup is that Haskell's nonstrict semantics makes the whole issue a bit murkier.

Nothing gets evaluated if it doesn't need to be, according to nonstrictness. In the following code, will `length undefined` be evaluated?

```
[4, 10, length undefined, 12]
```

If you type this into GHCi, it seems strict — you'll get an error. However, our question was something of a trick. It doesn't make sense to state whether a value gets evaluated unless we're doing something to this value. Think about it: if we type in `head [1, 2, 3]` into GHCi, the only reason we have to do any evaluation whatsoever is because GHCi has to print us out the result. Typing `[4, 10, length undefined, 12]` again requires GHCi to print that list back to us, so it must evaluate it to normal form. In your average Haskell program, nothing at all will be evaluated until we come to perform the IO in `main`. So it makes no sense to say whether something is evaluated or not unless we know what it's being passed to, one level up. One lesson here is: don't blindly trust GHCi because *everything in GHCi is filtered through IO!*

So when we say "Does `f x` force `x`?" what we really mean is "Given that we're forcing `f x`, does `x` get forced as a result?". Now we can turn our attention back to `id`. If we force `id x` to normal form, then `x` will be forced to normal form, so we conclude that `id` is strict. `id` itself doesn't evaluate its argument, it just hands it on to the caller who will. One way to see this is in the following code:

```
-- We evaluate the right-hand of the let-binding to WHNF by pattern-matching
-- against it.
let (x, y) = undefined in x -- Error, because we force undefined.
let (x, y) = id undefined in x -- Error, because we force undefined.
```

`id` doesn't "stop" the forcing, so it is strict. Contrast this to a clearly lazy function, `const (3, 4)`:

```
let (x, y) = undefined in x -- Error, because we force undefined.
let (x, y) = const (3, 4) undefined -- No error, because const (3, 4) is lazy.
```

66.3.3 The denotational view on things

If you're familiar with denotational semantics (perhaps you've read the wikibook chapter^{2?}), then the strictness of a function can be summed up very succinctly:

$$f \perp = \perp \Leftrightarrow f \text{ is strict}$$

Assuming that, we can say that everything with type `forall a. a`, including `undefined`, `error "any string"`, `throw` and so on, has denotation \perp .

66.4 Lazy pattern matching

You might have seen pattern matches like the following in Haskell sources.

```
-- From Control.Arrow
(***) f g ~(x, y) = (f x, g y)
```

The question is: what does the tilde sign (\sim) mean in the above pattern match? \sim makes a *lazy pattern* or *irrefutable pattern*. Normally, if you pattern match using a constructor as part of the pattern, you have to evaluate any argument passed into that function to make sure it matches the pattern. For example, if you had a function like the above, the third argument would be evaluated when you call the function to make sure the value matches the pattern. (Note that the first and second arguments won't be evaluated, because the patterns `f` and `g` match anything. Also it's worth noting that the *components* of the tuple won't be evaluated: just the 'top level'. Try `let f (Just x) = 1 in f (Just undefined)` to see this.)

However, prepending a pattern with a tilde sign delays the evaluation of the value until the component parts are actually used. But you run the risk that the value might not match the pattern — you're telling the compiler 'Trust me, I know it'll work out'. (If it turns out it doesn't match the pattern, you get a runtime error.) To illustrate the difference:

```
Prelude> let f (x,y) = 1
Prelude> f undefined
*** Exception: Prelude.undefined

Prelude> let f ~(x,y) = 1
Prelude> f undefined
1
```

In the first example, the value is evaluated because it has to match the tuple pattern. You evaluate `undefined` and get `undefined`, which stops the proceedings. In the latter example, you don't bother evaluating the parameter until it's needed, which turns out to be never,

so it doesn't matter you passed it `undefined`. To bring the discussion around in a circle back to `(***)`:

```
Prelude> (const 1 *** const 2) undefined
(1,2)
```

If the pattern weren't irrefutable, the example would have failed.

66.4.1 When does it make sense to use lazy patterns?

Essentially, use lazy patterns when you only have the single constructor for the type, e.g. tuples. Multiple equations won't work nicely with irrefutable patterns. To see this, let's examine what would happen were we to make `head` have an irrefutable pattern:

```
head' :: [a] -> a
head' []      = undefined
head' ~(x:xs) = x
```

We're using one of these patterns for sure, and we need not evaluate even the top level of the argument until absolutely necessary, so we don't know whether it's an empty list or a cons cell. As we're using an *irrefutable* pattern for the first equation, this will match, and the function will always return `undefined`.

Exercises:

- Why won't changing the order of the equations to `head'` help here?
- If the first equation is changed to use an ordinary refutable pattern, will the behavior of `head'` still be different from that of `head`? If so, how?

66.5 Benefits of nonstrict semantics

Why make Haskell a nonstrict language in the first place? What advantages are there?

66.5.1 Separation of concerns without time penalty

Lazy evaluation encourages a kind of "what you see is what you get" mentality when it comes to coding. For example, let's say you wanted to find the lowest three numbers in a long list. In Haskell this is achieved extremely naturally: `take 3 (sort xs)`. However a naïve translation of that code in a strict language would be a very bad idea! It would involve computing the entire sorted list, then chopping off all but the first three elements. However, with lazy evaluation we stop once we've sorted the list up to the third element, so this natural definition turns out to be efficient (depending on the implementation of `sort`).

To give a second example, the function `isInfixOf`³ from `Data.List` allows you to see if one string is a substring of another string. It's easily definable as:

³ <http://haskell.org/ghc/docs/latest/html/libraries/base/Data-List.html#v%3AisInfixOf>

```
isInfixOf :: Eq a => [a] -> [a] -> Bool
isInfixOf x y = any (isPrefixOf x) (tails y)
```

Again, this would be suicide in a strict language as computing all the tails of a list would be very time-consuming. However, here we only evaluate enough elements of each tail to determine whether it has prefix `x` or not, and stop and return `True` once we found one with prefix `x`.

There are many more examples along these lines.⁴ So we can write code that looks and feels natural and doesn't incur any time penalty.

However, as always in Computer Science (and in life), a tradeoff exists (in particular, a space-time tradeoff). Using a thunk instead of a plain `Int` for a trivial calculation (like `2+2`) can be a waste. For more examples, see the page on `./Strictness`⁵.

66.5.2 Improved code reuse

Often code reuse is desirable.

For example, we'll take again (but in more detail) `isInfixOf`⁶ from `Data.List`. Let's look at the full definition:

```
-- From the Prelude
or = foldr (||) False
any p = or . map p

-- From Data.List
isPrefixOf [] _ = True
isPrefixOf _ [] = False
isPrefixOf (x:xs) (y:ys) = x == y && isPrefixOf xs ys

tails [] = [[]]
tails xss@(_:xs) = xss : tails xs

-- Our function
isInfixOf :: Eq a => [a] -> [a] -> Bool
isInfixOf x y = any (isPrefixOf x) (tails y)
```

Where `any`, `isPrefixOf` and `tails` are the functions taken from the `Data.List` library. This function determines if its first parameter, `x` occurs as a subsequence of its second, `y`; when applied on `String`'s (i.e. `[Char]`), it checks if `x` is a substring of `y`. Read in a strict way, it forms the list of all the tails of `y`, then checks them all to see if any of them have `x` as a prefix. In a strict language, writing this function this way (relying on the already-written programs `any`, `isPrefixOf`, and `tails`) would be silly, because it would be far slower than it needed to be. You'd end up doing direct recursion again, or in an imperative language, a couple of nested loops. You might be able to get some use out of `isPrefixOf`, but you certainly wouldn't use `tails`. You might be able to write a usable shortcutting `any`, but it would be more work, since you wouldn't want to use `foldr` to do it.

4 In general, expressions like `prune . generate`, where `generate` produces a list of items and `prune` cuts them down, will be much more efficient in a nonstrict language.

5 Chapter 67 on page 511

6 <http://haskell.org/ghc/docs/latest/html/libraries/base/Data-List.html#v%3AisInfixOf>

Now, in a lazy language, all the shortcutting is done for you. You don't end up rewriting `foldr` to shortcut when you find a solution or rewriting the recursion done in tails so that it will stop early again. You can reuse standard library code better. Laziness isn't just a constant-factor speed thing, it makes a qualitative impact on the code which is reasonable to write. In fact, it's commonplace to define infinite structures, and then only use as much as is needed, rather than having to mix up the logic of constructing the data structure with code that determines whether any part is needed. Code modularity is increased, as laziness gives you more ways to chop up your code into small pieces, each of which does a simple task of generating, filtering, or otherwise manipulating data.

Why Functional Programming Matters⁷ largely focuses on examples where laziness is crucial and provides a strong argument for lazy evaluation being the default.

66.5.3 Infinite data structures

Examples:

```
fibs = 1:1:zipWith (+) fibs (tail fibs)
"rock-scissors-paper" example from Bird&Wadler
prune . generate
```

Infinite data structures usually tie a knot, too, but the Sci-Fi-Explanation of that is better left to the next section. One could move the next section before this one but I think that infinite data structures are simpler than tying general knots

66.6 Common nonstrict idioms

66.6.1 Tying the knot

More practical examples?

```
repMin
```

Sci-Fi-Explanation: "You can borrow things from the future as long as you don't try to change them". Advanced: the "Blueprint"-technique. Examples: the one from the haskellwiki, the one from the mailing list.

At first a pure functional language seems to have a problem with circular data structures. Suppose I have a data type like this:

```
data Foo a = Foo {value :: a, next :: Foo a}
```

If I want to create two objects "x" and "y" where "x" contains a reference to "y" and "y" contains a reference to "x" then in a conventional language this is straightforward: create the objects and then set the relevant fields to point to each other:

⁷ <http://www.cse.chalmers.se/~rjmh/Papers/whyfp.html>

```

-- Not Haskell code
x := new Foo;
y := new Foo;
x.value := 1;
x.next := y;
y.value := 2
y.next := x;

```

In Haskell this kind of modification is not allowed. So instead we depend on lazy evaluation:

```

circularFoo :: Foo Int
circularFoo = x
  where
    x = Foo 1 y
    y = Foo 2 x

```

This depends on the fact that the "Foo" constructor is a function, and like most functions it gets evaluated lazily. Only when one of the fields is required does it get evaluated.

It may help to understand what happens behind the scenes here. When a lazy value is created (for example, by a call to "Foo"), the compiler generates an internal data structure called a "thunk" containing the function call and arguments. When the value of the function is demanded, the function is called (as you would expect). But then the thunk data structure is replaced with the return value. Thus, anything else that refers to that value gets it straight away without the need to call the function.

(Note that the Haskell language standard makes no mention of thunks: they are an implementation mechanism. From the mathematical point of view this is a straightforward example of mutual recursion.)

So, when we call "circularFoo" the result "x" is actually a thunk. One of the arguments is a reference to a second thunk representing "y". This in turn has a reference back to the thunk representing "x". If we then use the value "next x" this forces the "x" thunk to be evaluated and returns a reference to the "y" thunk. If I use the value "next \$ next x" then I force the evaluation of both thunks. So now both thunks have been replaced with the actual "Foo" structures, referring to each other. Which is what we wanted.

This is most often applied with constructor functions, but it isn't limited just to constructors. You can just as readily write:

```

x = f y
y = g x

```

The same logic applies.

66.6.2 Memoization, Sharing and Dynamic Programming

Dynamic programming with immutable arrays. DP with other finite maps, Hinze's paper "Trouble shared is Trouble halved". Let-floating $\lambda x \rightarrow \text{let } z = \text{foo } x \text{ in } \lambda y \rightarrow \dots$

66.7 Conclusions about laziness

<--! Move conclusions to the introduction? -->

Laziness:

- Can make qualitative improvements to performance!
- Can hurt performance in some other cases.
- Makes code simpler.
- Makes hard problems conceivable.
- Allows for separation of concerns with regard to generating and processing data.

66.8 References

- Laziness on the Haskell wiki⁸
- Lazy evaluation tutorial on the Haskell wiki⁹

⁸ <http://www.haskell.org/haskellwiki/Performance/Laziness>

⁹ http://www.haskell.org/haskellwiki/Haskell/Lazy_Evaluation

67 Strictness

67.1 Difference between strict and lazy evaluation

Strict evaluation, or eager evaluation, is an evaluation strategy where expressions are evaluated as soon as they are bound to a variable. For example, with strict evaluation, when $x = 3 * 7$ is read, $3 * 7$ is immediately computed and 21 is bound to x . Conversely, with lazy evaluation¹ values are only computed when they are needed. In the example $x = 3 * 7$, $3 * 7$ isn't evaluated until it's needed, like if you needed to output the value of x .

67.2 Why laziness can be problematic

Lazy evaluation often involves objects called thunks. A thunk is a placeholder object, specifying not the data itself, but rather how to compute that data. An entity can be replaced with a thunk to compute that entity. When an entity is copied, whether or not it is a thunk doesn't matter - it's copied as is (on most implementations, a pointer to the data is created). When an entity is evaluated, it is first checked if it is thunk; if it's a thunk, then it is executed, otherwise the actual data is returned. It is by the magic of thunks that laziness can be implemented.

Generally, in the implementation the thunk is really just a pointer to a piece of (usually static) code, plus another pointer to the data the code should work on. If the entity computed by the thunk is larger than the pointer to the code and the associated data, then a thunk wins out in memory usage. But if the entity computed by the thunk is smaller, the thunk ends up using more memory.

As an example, consider an infinite length list generated using the expression `iterate (+ 1) 0`. The size of the list is infinite, but the code is just an add instruction, and the two pieces of data, 1 and 0, are just two Integers. In this case, the thunk representing that list takes much less memory than the actual list, which would take infinite memory.

However, as another example consider the number generated using the expression `4 * 13 + 2`. The value of that number is 54, but in thunk form it is a multiply, an add, and three numbers. In such a case, the thunk loses in terms of memory.

Often, the second case above will consume so much memory that it will consume the entire heap and force the garbage collector. This can slow down the execution of the program significantly. And that, in fact, is the main reason why laziness can be problematic.

Additionally, if the resulting value *is* used, no computation is saved; instead, a slight overhead (of a constant factor) for building the thunk is paid. However, this overhead is not

¹ Chapter 66 on page 499

something the programmer should deal with most of the times; more important factors must be considered and may give a much bigger improvements; additionally, optimizing Haskell compilers like GHC can perform 'strictness analysis' and remove that slight overhead.

67.3 Strictness annotations

67.4 seq

67.4.1 DeepSeq

67.5 References

- [Strictness on the Haskell wiki](http://www.haskell.org/haskellwiki/Performance/Strictness)²

² <http://www.haskell.org/haskellwiki/Performance/Strictness>

68 Algorithm complexity

Complexity Theory is the study of how long a program will take to run, depending on the size of its input. There are many good introductory books to complexity theory and the basics are explained in any good algorithms book. I'll keep the discussion here to a minimum.

The idea is to say how well a program scales with more data. If you have a program that runs quickly on very small amounts of data but chokes on huge amounts of data, it's not very useful (unless you know you'll only be working with small amounts of data, of course). Consider the following Haskell function to return the sum of the elements in a list:

```
sum [] = 0
sum (x:xs) = x + sum xs
```

How long does it take this function to complete? That's a very difficult question; it would depend on all sorts of things: your processor speed, your amount of memory, the exact way in which the addition is carried out, the length of the list, how many other programs are running on your computer, and so on. This is far too much to deal with, so we need to invent a simpler model. The model we use is sort of an arbitrary "machine step." So the question is "how many machine steps will it take for this program to complete?" In this case, it only depends on the length of the input list.

If the input list is of length 0, the function will take either 0 or 1 or 2 or some very small number of machine steps, depending exactly on how you count them (perhaps 1 step to do the pattern matching and 1 more to return the value 0). What if the list is of length 1? Well, it would take however much time the list of length 0 would take, plus a few more steps for doing the first (and only element).

If the input list is of length n , it will take however many steps an empty list would take (call this value y) and then, for each element it would take a certain number of steps to do the addition and the recursive call (call this number x). Then, the total time this function will take is $nx + y$ since it needs to do those additions n many times. These x and y values are called *constant values*, since they are independent of n , and actually depend only on exactly how we define a machine step, so we really don't want to consider them all that important. Therefore, we say that the complexity of this `sum` function is $\mathcal{O}(n)$ (read "order n "). Basically saying something is $\mathcal{O}(n)$ means that for some constant factors x and y , the function takes $nx + y$ machine steps to complete.

Consider the following sorting algorithm for lists (commonly called "insertion sort"):

```
sort [] = []
sort [x] = [x]
sort (x:xs) = insert (sort xs)
               where insert [] = [x]
```

```
insert (y:ys) | x <= y    = x : y : ys
            | otherwise = y : insert ys
```

The way this algorithm works is as follows: if we want to sort an empty list or a list of just one element, we return them as they are, as they are already sorted. Otherwise, we have a list of the form $x:xs$. In this case, we sort xs and then want to insert x in the appropriate location. That's what the `insert` function does. It traverses the now-sorted tail and inserts x wherever it naturally fits.

Let's analyze how long this function takes to complete. Suppose it takes $f(n)$ steps to sort a list of length n . Then, in order to sort a list of n -many elements, we first have to sort the tail of the list first, which takes $f(n-1)$ time. Then, we have to insert x into this new list. If x has to go at the end, this will take $\mathcal{O}(n-1) = \mathcal{O}(n)$ steps. Putting all of this together, we see that we have to do $\mathcal{O}(n)$ amount of work $\mathcal{O}(n)$ many times, which means that the entire complexity of this sorting algorithm is $\mathcal{O}(n^2)$. Here, the squared is not a constant value, so we cannot throw it out.

What does this mean? Simply that for really long lists, the `sum` function won't take very long, but that the `sort` function will take quite some time. Of course there are algorithms that run much more slowly than simply $\mathcal{O}(n^2)$ and there are ones that run more quickly than $\mathcal{O}(n)$. (Also note that a $\mathcal{O}(n^2)$ algorithm may actually be much faster than a $\mathcal{O}(n)$ algorithm in practice, if it takes much less time to perform a single step of the $\mathcal{O}(n^2)$ algorithm.)

Consider the random access functions for lists and arrays. In the worst case, accessing an arbitrary element in a list of length n will take $\mathcal{O}(n)$ time (think about accessing the last element). However with arrays, you can access any element immediately, which is said to be in *constant* time, or $\mathcal{O}(1)$, which is basically as fast as any algorithm can go.

There's much more in complexity theory than this, but this should be enough to allow you to understand all the discussions in this tutorial. Just keep in mind that $\mathcal{O}(1)$ is faster than $\mathcal{O}(n)$ is faster than $\mathcal{O}(n^2)$, etc.

68.1 Optimising

68.1.1 Profiling

69 Libraries Reference

70 The Hierarchical Libraries

Haskell has a rich and growing set of libraries. They fall into several groups:

- The Standard Prelude (often referred to as just "the Prelude") is defined in the Haskell 2010 standard¹ and imported automatically to every module you write. It defines standard types such as strings, lists, numbers, and the basic functions on those, such as arithmetic, `map`, and `foldr`.
- The Standard Libraries are also defined in the language standard, but you have to import them when you need them. The specification of these libraries can also be found in the Haskell 2010 standard.
- Since 1998, the Standard Libraries have been gradually extended, and the resulting *de facto* standard is known as the Base Libraries. The same set is available for both Hugs and GHC.
- Other libraries may be bundled with the various compilers. In particular, GHC includes a handful of commonly used libraries, including important packages such as `containers`, `text`, and `bytestring`.²
- Many other libraries are available from Hackage³, and can be installed using the `cabal` utility.

When Haskell 98 was standardized, modules were given a flat namespace. That turned out to be inadequate, and a hierarchical namespace has been added by allowing dots in module names. For backward compatibility the standard libraries can still be accessed by their non-hierarchical names, so the modules `List` and `Data.List` both refer to the standard list library.

For details of how to import libraries into your program, see the Modules⁴ chapter. For an explanation of the Cabal system for packaging Haskell software see Haskell/Packaging⁵.

70.1 Haddock Documentation

Library reference documentation is generally produced using the Haddock tool. The libraries shipped with GHC are documented in this way. You can view the documentation online⁶, and if you have installed GHC then there should also be a local copy.

1 <https://www.haskell.org/onlinereport/haskell2010/>

2 *Packages* are the units of distribution of libraries. They consist of a set modules, packaged for ease of distribution and installation.

3 <http://hackage.haskell.org/>

4 Chapter 22 on page 139

5 Chapter 81 on page 567

6 <http://www.haskell.org/ghc/docs/latest/html/libraries/index.html>

Haddock produces hyperlinked documentation, so every time you see a function, type, or class name you can click on it to get to the definition. The sheer wealth of libraries available can be intimidating, so this tutorial will point out the highlights.

Note that Haddock cross-references types and classes by instance. For example, in the `Data.Maybe`⁷ library the `Maybe` data type is listed as an instance of `Ord`:

```
Ord a => Ord (Maybe a)
```

If you declare a type `Foo` is an instance of `Ord` then the type `Maybe Foo` will automatically be an instance of `Ord` as well. If you click on the word `Ord` in the document then you will be taken to the definition of the `Ord` class and its (very long) list of instances. The instance for `Maybe` will be down there as well.

⁷ <http://www.haskell.org/ghc/docs/latest/html/libraries/base/Data-Maybe.html>

71 Lists

The **List** datatype (see `Data.List`¹) is the fundamental data structure in Haskell — this is the basic building-block of data storage and manipulation. In computer science terms it is a singly-linked list. In the hierarchical library system the `List` module is stored in `Data.List`; but this module only contains utility functions. The definition of list itself is integral to the Haskell language.

71.1 Theory

A singly-linked list is a set of values in a defined order. The list can only be traversed in one direction (i.e., you cannot move back and forth through the list like tape in a cassette machine).

The list of the first 5 positive integers is written as

```
[ 1, 2, 3, 4, 5 ]
```

We can move through this list, examining and changing values, from left to right, but not in the other direction. This means that the list

```
[ 5, 4, 3, 2, 1 ]
```

is not just a trivial change in perspective from the previous list, but the result of significant computation ($O(n)$ in the length of the list).

71.2 Definition

The polymorphic list datatype can be defined with the following recursive definition:

```
data [a] = []
         | a : [a]
```

The "base case" for this definition is `[]`, the empty list. In order to put something into this list, we use the `(:)` constructor

¹ <http://www.haskell.org/ghc/docs/latest/html/libraries/base/Data-List.html>

```
emptyList = []  
oneElem = 1:[]
```

The `(:)` (pronounced *cons*) is right-associative, so that creating multi-element lists can be done like

```
manyElems = 1:2:3:4:5:[]
```

or even just

```
manyElems' = [1,2,3,4,5]
```

71.3 Basic list usage

71.3.1 Prepending

It's easy to hard-code lists without `cons`, but run-time list creation will use `cons`. For example, to push an argument onto a simulated stack, we would use:

```
push :: Arg -> [Arg] -> [Arg]  
push arg stack = arg:stack
```

71.3.2 Pattern-matching

If we want to examine the top of the stack, we would typically use a `peek` function. We can try pattern-matching for this.

```
peek :: [Arg] -> Maybe Arg  
peek [] = Nothing  
peek (a:as) = Just a
```

The `a` before the `cons` in the pattern matches the head of the list. The `as` matches the tail of the list. Since we don't actually want the tail (and it's not referenced anywhere else in the code), we can tell the compiler this explicitly, by using a wild-card match, in the form of an underscore:

```
peek (a:_) = Just a
```

71.4 List utilities

FIXME: is this not covered in the chapter on list manipulation²?

71.4.1 Maps

71.4.2 Folds, unfolds and scans

71.4.3 Length, head, tail etc.

UNKNOWN TEMPLATE BOOKCATEGORY /Not in book³

² Chapter 14 on page 95

³ <https://en.wikibooks.org/wiki/%2FNot%20in%20book>

72 Arrays

Haskell'98 supports just one array constructor type, namely `Array`¹, which gives you immutable boxed arrays. "Immutable" means that these arrays, like any other pure functional data structure, have contents fixed at construction time. You can't modify them, only query. There are "modification" operations, but they just return new arrays and don't modify the original one. This makes it possible to use Arrays in pure functional code along with lists. "Boxed" means that array elements are just ordinary Haskell (lazy) values, which are evaluated on demand, and can even contain bottom (undefined) value. You can learn how to use these arrays at <http://haskell.org/tutorial/arrays.html> and I'd recommend that you read this before proceeding to the rest of this page.

Nowadays the main Haskell compilers, GHC and Hugs, ship with the same set of Hierarchical Libraries², and these libraries contain a new implementation of arrays which is backward compatible with the Haskell'98 one, but which has far more features. Suffice it to say that these libraries support 9 types of array constructors: `Array`, `UArray`, `IOArray`, `IOUArray`, `STArray`, `STUArray`, `DiffArray`, `DiffUArray` and `StorableArray`. It is no wonder that the array libraries are a source of so much confusion for new Haskellers. However, they are actually very simple - each provides just one of two interfaces, and one of these you already know.

72.1 Quick reference

	Immutable instance <code>IArray a e</code>	IO monad instance <code>MArray a e IO</code>	ST monad instance <code>MArray a e ST</code>
Standard	<code>Array</code> <code>DiffArray</code>	<code>IOArray</code>	<code>STArray</code>
Unboxed	<code>UArray</code> <code>DiffUArray</code>	<code>IOUArray</code> <code>StorableArray</code>	<code>STUArray</code>

72.2 Immutable arrays

The first interface provided by the new array library, is defined by the typeclass `IArray` (which stands for "immutable array" and defined in the module `Data.Array.IArray`³) and

1 <http://haskell.org/onlinereport/array.html>
2 <http://www.haskell.org/ghc/docs/latest/html/libraries/index.html>
3 <http://hackage.haskell.org/packages/archive/array/latest/doc/html/Data-Array-IArray.html>

defines the same operations that were defined for `Array` in Haskell '98. Here's a simple example of its use that prints `(37,64)`:

```
import Data.Array
buildPair :: (Int, Int)
buildPair = let arr = listArray (1,10) (repeat 37) :: Array Int Int
             arr' = arr // [(1, 64)]
             in (arr ! 1, arr' ! 1)

main = print buildPair
```

The big difference is that it is now a typeclass and there are 4 array type constructors, each of which implements this interface: `Array`, `UArray`, `DiffArray`, and `DiffUArray`. We will later describe the differences between them and the cases when these other types are preferable to use instead of the good old `Array`. Also note that to use `Array` type constructor together with other new array types, you need to import `Data.Array.IArray` module instead of `Data.Array`.

72.3 Mutable IO arrays

The second interface is defined by the type class `MArray` (which stands for "mutable array" and is defined in the module `Data.Array.MArray`⁴) and contains operations to update array elements in-place. Mutable arrays are very similar to `IORefs`, only they contain multiple values. Type constructors for mutable arrays are `IOArray` and `IOUArray` (in `Data.Array.IO`⁵) and operations which create, update and query these arrays all belong to the `IO` monad:

```
import Data.Array.IO
main = do arr <- newArray (1,10) 37 :: IO (IOArray Int Int)
        a <- readArray arr 1
        writeArray arr 1 64
        b <- readArray arr 1
        print (a,b)
```

This program creates an array of 10 elements with all values initially set to 37. Then it reads the first element of the array. After that, the program modifies the first element of the array and then reads it again. The type declaration in the second line is necessary because our little program doesn't provide enough context to allow the compiler to determine the concrete type of `arr`.

72.4 Mutable arrays in ST monad

In the same way that `IORef` has its more general cousin `STRef`, `IOArray` has a more general version `STArray` (and similarly, `IOUArray` is parodied by `STUArray`; both defined in `Data.Array.ST`⁶). These array types allow one to work with mutable arrays in the `ST` monad:

4 <http://hackage.haskell.org/packages/archive/array/latest/doc/html/Data-Array-MArray.html>
 5 <http://hackage.haskell.org/packages/archive/array/latest/doc/html/Data-Array-IO.html>
 6 <http://hackage.haskell.org/packages/archive/array/latest/doc/html/Data-Array-ST.html>

```

import Control.Monad.ST
import Data.Array.ST

buildPair = do arr <- newArray (1,10) 37 :: ST s (STArray s Int Int)
              a <- readArray arr 1
              writeArray arr 1 64
              b <- readArray arr 1
              return (a,b)

main = print $ runST buildPair

```

Believe it or not, now you know all that is needed to *use* any array type. Unless you are interested in speed issues, just use `Array`, `IOArray` and `STArray` where appropriate. The following topics are almost exclusively about selecting the proper array type to make programs run faster.

72.5 Freezing and thawing

Haskell allows conversion between immutable and mutable arrays with the `freeze` and `thaw` functions:

```

freeze :: (Ix i, MArray a e m, IArray b e) => a i e -> m (b i e)
thaw   :: (Ix i, IArray a e, MArray b e m) => a i e -> m (b i e)

```

For instance, the following converts an `Array` into an `STArray`, alters it, and then converts it back:

```

import Data.Array
import Control.Monad.ST
import Data.Array.ST

buildPair :: (Int, Int)
buildPair = let arr = listArray (1,10) (repeat 37) :: Array Int Int
            arr' = modifyAsST arr
            in (arr ! 1, arr' ! 1)

modifyAsST :: Array Int Int -> Array Int Int
modifyAsST arr = runST $ do starr <- thaw arr
                          compute starr
                          newarr <- freeze starr
                          return newarr

compute :: STArray s Int Int -> ST s ()
compute arr = do writeArray arr 1 64

main = print buildPair

```

Freezing and thawing both copy the entire array. If you want to use the same memory locations before and after freezing or thawing but can allow some access restrictions, see the section `Unsafe operations and running over array elements`⁷.

⁷ Chapter 72.11 on page 529

72.6 DiffArray

As we already stated, the update operation on immutable arrays (IArray) just creates a new copy of the array, which is very inefficient, but it is a pure operation which can be used in pure functions. On the other hand, updates on mutable arrays (MArray) are efficient but can be done only in monadic code. DiffArray (defined in `Data.Array.Diff`⁸) combines the best of both worlds - it supports the IArray interface and therefore can be used in a purely functional way, but internally it uses the efficient update of MArrays.

How does this trick work? DiffArray has a pure external interface, but internally it is represented as a reference to an IOArray.

When the `'//'` operator is applied to a diff array, its contents are physically updated in place. The old array silently changes its representation without changing the visible behavior: it stores a link to the new current array along with the difference to be applied to get the old contents.

So if a diff array is used in a single-threaded style, that is, after `'//'` application the old version is no longer used, then `a ! i` takes $O(1)$ time and `a // d` takes $O(n)$ time. Accessing elements of older versions gradually becomes slower.

Updating an array which is not current makes a physical copy. The resulting array is unlinked from the old family. So you can obtain a version which is guaranteed to be current and thus has fast element access by performing the "identity update", `old // []`.

The library provides two "differential" array constructors - DiffArray, made internally from IOArray, and DiffUArray, based on IOUArray. If you really need to, you can construct new "differential" array types from any 'MArray' types living in the 'IO' monad. See the module documentation⁹ for further details.

Usage of DiffArray doesn't differ from that of Array, the only difference is memory consumption and speed:

```
import Data.Array.Diff

main = do
  let arr = listArray (1,1000) [1..1000] :: DiffArray Int Int
      a = arr ! 1
      arr2 = arr // [(1,37)]
      b = arr2 ! 1
  print (a,b)
```

You can use `'seq'` to force evaluation of array elements prior to updating an array:

```
import Data.Array.Diff

main = do
  let arr = listArray (1,1000) [1..1000] :: DiffArray Int Int
      a = arr ! 1
      b = arr ! 2
      arr2 = a `seq` b `seq` (arr // [(1,37),(2,64)])
      c = arr2 ! 1
  print (a,b,c)
```

8 <http://hackage.haskell.org/packages/archive/array/latest/doc/html/Data-Array-Diff.html>
 9 <http://www.haskell.org/ghc/docs/latest/html/libraries/base/Data-Array-Diff.html>

72.7 Unboxed arrays

In most implementations of lazy evaluation, values are represented at runtime as pointers to either their value, or code for computing their value. This extra level of indirection, together with any extra tags needed by the runtime, is known as a box. The default "boxed" arrays consist of many of these boxes, each of which may compute its value separately. This allows for many neat tricks, like recursively defining an array's elements in terms of one another, or only computing the specific elements of the array which are ever needed. However, for large arrays, it costs a lot in terms of overhead, and if the entire array is always needed, it can be a waste.

Unboxed arrays (defined in `Data.Array.Unboxed`¹⁰) are more like arrays in C - they contain just the plain values without this extra level of indirection, so that, for example, an array of 1024 values of type `Int32` will use only 4 kb of memory. Moreover, indexing of such arrays can be significantly faster.

Of course, unboxed arrays have their own disadvantages. First, unboxed arrays can be made only of plain values having a fixed size -- `Int`, `Word`, `Char`, `Bool`, `Ptr`, `Double` and others (listed in the `UArray` class definition¹¹). You can even implement unboxed arrays yourself for other simple types, including enumerations. But `Integer`, `String` and any other types defined with variable size cannot be elements of unboxed arrays. Second, without that extra level of indirection, all of the elements in an unboxed array must be evaluated when the array is evaluated, so you lose the benefits of lazy evaluation. Indexing the array to read just one element will construct the entire array. This is not much of a loss if you will eventually need the whole array, but it does prevent recursively defining the array elements in terms of each other, and may be too expensive if you only ever need specific values. Nevertheless, unboxed arrays are a very useful optimization instrument, and I recommend using them as much as possible.

All main array types in the library have unboxed counterparts:

<code>Array</code>	-	<code>UArray</code>		(module <code>Data.Array.Unboxed</code>)
<code>IOArray</code>	-	<code>IOUArray</code>		(module <code>Data.Array.IO</code>)
<code>STArray</code>	-	<code>STUArray</code>		(module <code>Data.Array.ST</code>)
<code>DiffArray</code>	-	<code>DiffUArray</code>		(module <code>Data.Array.Diff</code>)

So, basically replacing boxed arrays in your program with unboxed ones is very simple - just add 'U' to the type signatures, and you are done! Of course, if you change `Array` to `UArray`, you also need to add "Data.Array.Unboxed" to your imports list.

10 <http://hackage.haskell.org/packages/archive/array/latest/doc/html/Data-Array-Unboxed.html>
 11 <http://www.haskell.org/ghc/docs/latest/html/libraries/array/Data-Array-Unboxed.html#t%3AUArray>

72.8 StorableArray

A storable array (`Data.Array.Storable`¹²) is an IO-mutable array which stores its contents in a contiguous memory block living in the C heap. Elements are stored according to the class 'Storable'. You can obtain the pointer to the array contents to manipulate elements from languages like C.

It is similar to 'IOUArray' (in particular, it implements the same MArray interface) but slower. The advantage is that it's compatible with C through the foreign function interface. The memory addresses of storable arrays are fixed, so you can pass them to C routines.

The pointer to the array contents is obtained by 'withStorableArray'. The idea is similar to 'ForeignPtr' (used internally here). The pointer should be used only during execution of the 'IO' action returned by the function passed as argument to 'withStorableArray'.

```
{-# OPTIONS_GHC -fglasgow-exts #-}
import Data.Array.Storable
import Foreign.Ptr
import Foreign.C.Types

main = do arr <- newArray (1,10) 37 :: IO (StorableArray Int Int)
         a <- readArray arr 1
         withStorableArray arr
           (\ptr -> memset ptr 0 40)
         b <- readArray arr 1
         print (a,b)

foreign import ccall unsafe "string.h"
  memset :: Ptr a -> CInt -> CSize -> IO ()
```

If you want to use this pointer afterwards, ensure that you call 'touchStorableArray' AFTER the last use of the pointer, so that the array will be not freed too early.

Additional comments: GHC 6.6 should make access to a 'StorableArray' as fast as to any other unboxed array. The only difference between 'StorableArray' and 'UArray' will be that UArray lies in relocatable part of GHC heap while 'StorableArray' lies in non-relocatable part and therefore keep the fixed address, what allow to pass this address to the C routines and save it in the C data structures.

GHC 6.6 also adds 'unsafeForeignPtrToStorableArray' operation that allows to use any Ptr as address of 'StorableArray' and in particular work with arrays returned by C routines. Example of using this operation:

```
import Data.Array.Storable
import Foreign.Marshal.Alloc
import Foreign.Marshal.Array
import Foreign.ForeignPtr

main = do ptr <- mallocArray 10
         fptr <- newForeignPtr_ptr
         arr <- unsafeForeignPtrToStorableArray (1,10) fptr :: IO
         (StorableArray Int Int)
         writeArray arr 1 64
         a <- readArray arr 1
```

¹² <http://hackage.haskell.org/packages/archive/array/latest/doc/html/Data-Array-Storable.html>

```
print a
free ptr
```

This example allocs memory for 10 Ints (which emulates array returned by some C function), then converts returned 'Ptr Int' to 'ForeignPtr Int' and 'ForeignPtr Int' to 'StorableArray Int Int'. It then writes and reads first element of array. At the end, memory used by array is deallocated by 'free' which again emulates deallocation by C routines. We can also enable automatic freeing of allocated block by replacing "newForeignPtr_ ptr" with "newForeignPtr finalizerFree ptr". In this case memory will be automatically freed after last array usage, as for any other Haskell objects.

72.9 The Haskell Array Preprocessor (STPP)

Using mutable arrays in Haskell (IO and ST ones) is not very handy. But there is one tool which adds syntax sugar and makes using of such arrays very close to that in imperative languages. It is written by Hal Daume III and you can get it as <http://hal3.name/STPP/stpp.tar.gz>

Using this tool, you can index array elements in arbitrary complex expressions with just "arr[[i]]" notation and this preprocessor will automatically convert such syntax forms to appropriate calls to 'readArray' and 'writeArray'. Multi-dimensional arrays are also supported, with indexing in the form "arr[[i]][[j]]". See further descriptions at <http://hal3.name/STPP/>

72.10 ArrayRef library

The ArrayRef library¹³ reimplements array libraries with the following extensions:

- dynamic (resizable) arrays
- polymorphic unboxed arrays

It also adds syntax sugar¹⁴ what simplifies arrays usage. Although not so elegant as with STPP, it's on other hand implemented entirely inside Haskell language, without any pre-processors.

72.11 Unsafe operations and running over array elements

As mentioned above, there are operations that converts between mutable and immutable arrays of the same type, namely 'freeze' (mutable → immutable) and 'thaw' (immutable → mutable). These copy the entire array. If you are sure that a mutable array will not be modified or that an immutable array will not be used after the conversion, you can use unsafeFreeze/unsafeThaw instead - these operations convert array in-place if input and resulting arrays have the same memory representation (i.e. the same type and boxing). Please note that "unsafe*" operations modifies memory - they sets/clears flag in array header

¹³ http://haskell.org/haskellwiki/Library/ArrayRef#Reimplemented_Arrays_library

¹⁴ http://haskell.org/haskellwiki/Library/ArrayRef#Syntax_sugar_for_mutable_types

which tells about array mutability. So these operations can't be used together with multi-threaded access to array (using threads or some form of coroutines).

There are also operations that converts unboxed arrays to another element type, namely `castIOUArray` and `castSTUArray`. These operations rely on actual type representation in memory and therefore there is no any guarantees on their results. In particular, these operations can be used to convert any unboxable value to the sequence of bytes and vice versa, f.e. it's used in `AltBinary` library to serialize floating-point values. Please note that these operations don't recompute array bounds according to changed size of elements. You should do it yourself using `'sizeOf'` operation!

While arrays can have any type of indexes, internally any index after bounds checking is converted to plain `Int` value (position) and then one of low-level operations, `unsafeAt`, `unsafeRead`, `unsafeWrite`, is used. You can use these operations yourself in order to outpass bounds checking and make your program faster. These operations are especially useful if you need to walk through entire array:

```
-- | Returns a list of all the elements of an array, in the same order
-- as their indices.
elems arr = [ unsafeAt arr i | i <- [0 .. rangeSize (bounds arr)-1] ]
```

”unsafe*” operations in such loops are really safe because `'i'` loops only through positions of existing array elements.

72.12 GHC-specific topics

72.12.1 Parallel arrays (module `GHC.PArr`)

As we already mentioned, array library supports two array varieties - lazy boxed arrays and strict unboxed ones. Parallel array implements something intervening - it's a strict boxed immutable array. This keeps flexibility of using any data type as array element while makes both creation and access to such arrays much faster. Array creation implemented as one imperative loop that fills all array elements, while access to array elements don't need to check ”box”. It should be obvious that parallel arrays are not efficient in cases where calculation of array elements are rather complex and you will not use most of array elements. One more drawback of practical usage is that parallel arrays don't support `IArray` interface which means that you can't write generic algorithms which work both with `Array` and parallel array constructor.

Like many GHC extensions, this is described in a paper: `An Approach to Fast Arrays in Haskell`¹⁵, by Manuel M. T. Chakravarty and Gabriele Keller.

You can also look at sources of `GHC.PArr`¹⁶ module, which contains a lot of comments.

Special syntax for parallel arrays is enabled by `”ghc -fparr”` or `”ghci -fparr”` which is undocumented in user manual of GHC 6.4.1.

¹⁵ <http://www.cse.unsw.edu.au/~chak/papers/CK03.html>

¹⁶ <http://darcs.haskell.org/packages/base/GHC/PArr.hs>

72.12.2 Welcome to the machine

Array#, MutableArray#, ByteArray#, MutableByteArray#, pinned and moveable byte arrays

GHC heap contains two kinds of objects - some are just byte sequences, other contains pointers to other objects (so called "boxes"). This segregation allows to find chains of references when performing garbage collection and update these pointers when memory used by heap is compacted and objects are moved to new places. Internal (raw) GHC's type `Array#` represents a sequence of object pointers (boxes). There is low-level operation in ST monad which allocates array of specified size in heap, its type is something like `(Int -> ST s Array#)`. The `Array#` type is used inside `Array` type which represents boxed immutable arrays.

There is a different type for **mutable** boxed arrays (`IOArray/STArray`), namely `MutableArray#`. Separate type for mutable arrays required because of 2-stage garbage collection mechanism. Internal representation of `Array#` and `MutableArray#` are the same excluding for some flags in header and this makes possible to on-place convert `MutableArray#` to `Array#` and vice versa (this is that `unsafeFreeze` and `unsafeThaw` operations do).

Unboxed arrays are represented by the `ByteArray#` type. It's just a plain memory area in the heap, like the C's array. There are two primitive operations that create a `ByteArray#` of specified size - one allocates memory in normal heap and so this byte array can be moved each time when garbage collection occurs. This prevents converting of `ByteArray#` to plain memory pointer that can be used in C procedures (although it's still possible to pass current `ByteArray#` pointer to "unsafe foreign" procedure if it doesn't try to store this pointer somewhere). The second primitive allocates `ByteArray#` of specified size in "pinned" heap area, which contains objects with fixed place. Such byte array will never be moved by GC so its address can be used as plain `Ptr` and shared with C world. First way to create `ByteArray#` used inside implementation of all `UArray` types, second way used in `StorableArray` (although `StorableArray` can also point to data, allocated by C `malloc`).

There is also `MutableByteArray#` type which doesn't have much difference with `ByteArray#`, but GHC's primitives support only monadic read/write operations for `MutableByteArray#`, and only pure reads for `ByteArray#`, plus `unsafeFreeze/unsafeThaw` operations that change appropriate fields in headers of these arrays. This differentiation doesn't make much sense except for additional safety checks.

So, pinned `MutableByteArray#` or C-allocated memory used inside `StorableArray`, unpinned `MutableByteArray#` used inside `IOUArray` and `STUArray`, and unpinned `ByteArray#` are used inside `UArray`.

Both boxed and unboxed arrays API are almost the same:

```
marr <- alloc n           - allocates mutable array with given size
arr   <- unsafeFreeze marr - converts mutable array to immutable one
marr  <- unsafeThaw arr   - converts immutable array to mutable one
x     <- unsafeRead marr i - monadic reading of value with given index from
mutable array
unsafeWrite marr i x     - monadic writing of value with given index from
mutable array
let x = unsafeAt arr i   - pure reading of value with given index from
```

```
immutable array
(all indexes are counted from 0)
```

Based on these primitive operations, the arrays library implements indexing with any type and with any lower bound, bounds checking and all other high-level operations. Operations that creates/updates immutable arrays just creates them as mutable arrays in ST monad, make all required updates on this array and then use `unsafeFreeze` before returning array from `runST`. Operations on IO arrays are implemented via operations on ST arrays using `stToIO` operation.

72.12.3 Mutable arrays and GC

GHC implements 2-stage GC which is very fast - minor GC occurs after each 256 kb allocated and scans only this area (plus recent stack frames) when searching for a "live" data. This solution uses the fact that usual Haskell data are immutable and therefore any data structures that was created before previous minor GC can't point to the data structures created after this GC (due to immutability data can contain only "backward" references).

But this simplicity breaks when we add to the language mutable boxed references (`IORef`/`STRef`) and arrays (`IOArray`/`STArray`). On each GC, including minor ones, each element in mutable data structures should be scanned because it may be updated since last GC and now point to the data allocated since last GC.

For programs that contains a lot of data in mutable boxed arrays/references GC times may easily outweigh useful computation time. Ironically, one of such programs is GHC itself. Solution for such programs is to add to cmdline option like `" +RTS -A10m"` which increases size of minor GC chunks from 256 kb to 10 mb, i.e. makes minor GC 40 times less frequent. You can see effect of this change using `" +RTS -ssterr"` option - `"%GC time"` should significantly decrease.

There is a way to include this option into your executable so it will be used automatically on each execution - you should just add to your project C source file that contains the following line:

```
char *ghc_rts_opts = "-A10m";
```

Of course, you can increase or decrease this value according to your needs.

Increasing "-A" value don't comes for free - aside from obvious increasing of memory usage, execution times (of useful code) will also grow. Default "-A" value tuned to be close to modern CPU cache sizes that means that most of memory references are fall inside the cache. When 10 mb of memory are allocated before doing GC, this data locality is no more holds. So, increasing "-A" can either increase or decrease program speed, depending on its nature. Try various settings between 64 kb and 16 mb while running program with "typical" parameters and try to select a best setting for your concrete program and cpu combination.

There is also another way to avoid increasing GC times - use either unboxed or immutable arrays. Also note that immutable arrays are build as mutable ones and then "freezed", so during the construction time GC will also scan their contents.

Hopefully, GHC 6.6 fixed the problem - it remembers what references/arrays was updated since last GC and scans only them. You can suffer from the old problems only in the case when you use very large arrays.

Further information:

- RTS options to control the garbage collector¹⁷
- Problem description by Simon Marlow and report about GHC 6.6 improvements in this area¹⁸
- Notes about GHC garbage collector¹⁹
- Papers about GHC garbage collector²⁰

17 http://www.haskell.org/ghc/docs/latest/html/users_guide/runtime-control.html

18 <http://hackage.haskell.org/trac/ghc/ticket/650>

19 <http://hackage.haskell.org/trac/ghc/wiki/GarbageCollectorNotes>

20 <http://research.microsoft.com/~simonpj/Papers/papers.html#gc>

73 Maybe

The `Maybe` data is used with functions that might be unsuccessful. The full description is in `Maybe monad`¹ chapter.

73.1 Definition

The Standard Prelude defines the `Maybe` type as follows:

```
data Maybe a = Nothing | Just a
```

Recall that the type `a` is polymorphic and can contain complex types or even other monads (such as `IO ()` types).

73.2 Library functions

The module `Data.Maybe`, in the standard hierarchical libraries², contains a wealth of functions for working with `Maybe` values.

73.2.1 Querying

Two obvious functions give you information about a `Maybe` value:

73.2.2 `isJust`

`isJust` returns `True` if when given an argument in the form `Just _`.

```
isJust :: Maybe a -> Bool
isJust (Just _) = True
isJust Nothing  = False
```

73.2.3 `isNothing`

`isNothing` returns `True` if its argument is `Nothing`.

```
isNothing :: Maybe a -> Bool
isNothing (Just _) = False
isNothing Nothing  = True
```

¹ Chapter 31 on page 199

² <https://en.wikibooks.org/wiki/..%2F..%2FHierarchical%20libraries>

73.2.4 Getting out

There are a handful of functions for converting Maybe values to non-Maybe values.

maybe

`maybe` applies a given function to the internal value passed by a `Just` but otherwise returns a default value when given `Nothing`.

```
maybe :: b -> (a -> b) -> Maybe a -> b
maybe _ f (Just x) = f x
maybe z _ Nothing = z
```

fromMaybe

We might want to use `maybe` without applying any function to the `Just`. We can do that by calling `maybe` with the function `id`. `Data.Maybe` already has this as `fromMaybe`:

```
fromMaybe :: a -> Maybe a -> a
fromMaybe z = maybe z id
```

Note the use of point-free style. `maybe z id` evaluates to a function that is ready to take a Maybe value.

73.2.5 Lists and Maybe

The many similarities between lists and `Maybe` are discussed in the List monad³ chapter. Given the connections, there are a couple of functions for converting between one and the other:

listToMaybe

Failed computations return `[]` for lists and `Nothing` for `Maybe`. `listToMaybe` converts from the list to the `Maybe` monad. As `Maybe` can only hold one value, `listToMaybe` only takes the first solution from a list.

```
listToMaybe :: [a] -> Maybe a
listToMaybe [] = Nothing
listToMaybe (x:_) = Just x
```

maybeToList

The reverse `listToMaybe` is, of course, `maybeToList`:

```
maybeToList :: Maybe a -> [a]
maybeToList Nothing = []
maybeToList (Just x) = [x]
```

3 <https://en.wikibooks.org/wiki/Haskell%2FUnderstanding%20monads%2FLists>

73.2.6 Lists manipulation

There are a couple of functions which are analogues of the normal Prelude list manipulation functions but are specialized to `Maybe` values.

Continue on some failures

We might want an *OR* function that won't make a whole computation fail just because one part failed.

`catMaybes`

Given a list of `Maybe` values, `catMaybes` extracts all the values in the form `Just _`, and strips off the `Just` constructors. List comprehension does the job here (as we showed in the pattern matching chapter⁴):

```
catMaybes :: [Maybe a] -> [a]
catMaybes ms = [ x | Just x <- ms ]
```

`mapMaybe`

`mapMaybe` applies a function to a list and collects the successes. It can be understood as a composition of functions you already know:

```
mapMaybe :: (a -> Maybe b) -> [a] -> [b]
mapMaybe f xs = catMaybes (map f xs)
```

However, the actual definition in `Data.Maybe` traverses the list is potentially more efficient:

```
mapMaybe :: (a -> Maybe b) -> [a] -> [b]
mapMaybe _ [] = Just []
mapMaybe f (x:xs) =
  case f x of
    Just y -> y : mapMaybe f xs
    Nothing -> mapMaybe f xs
```

Stop on failure

Rather than *OR*, we might want to collect values if and only if all succeed.

`sequence`

```
sequence :: [Maybe a] -> Maybe [a]
sequence [] = Just []
sequence (Nothing:xs) = Nothing
sequence (Just x:xs) = case sequence xs of
```

4 Chapter 16 on page 109

```
Just xs' -> Just (x:xs')  
-         -> Nothing
```

74 Maps

The module `Data.Map` provides the `Map` datatype, which allows you to store *values* attached to specific *keys*. This is called a lookup table, dictionary or associative array in other languages.

74.1 Motivation

Very often it would be useful to have some kind of data structure that relates a value or list of values to a specific key. This is often called a dictionary after the real-world example: a real-life dictionary associates a definition (the value) to each word (the key); we say the dictionary is a *map from words to definitions*. A filesystem driver might keep a map from filenames to file information. A phonebook application might keep a map from contact names to phone numbers. Maps are a very versatile and useful datatype.

74.1.1 Why not just [(a, b)]?

You may have seen in other chapters that a list of pairs (or 'lookup table') is often used as a kind of map, along with the function `lookup :: [(a, b)] -> a -> Maybe b`. So why not just use a lookup table all the time? Here are a few reasons:

- Working with maps gives you access to a whole load more useful functions for working with lookup tables.
- Maps are implemented far more efficiently than a lookup table would be, specially in terms of lookup speed.¹

74.2 Library functions

The module `Data.Map` provides an absolute wealth of functions for dealing with Maps, including setlike operations like unions and intersections. The full list can be found in the core libraries documentation².

74.3 Example

The following example implements a password database. The user is assumed to be trusted, so is not authenticated and has access to view or change passwords.

¹ In the specific case of `Data.Map`, the implementation is based on *size balanced binary trees*.

² <http://haskell.org/ghc/docs/latest/html/libraries/containers/Data-Map.html>

```

{- A quick note for the over-eager refactorers out there: This is (somewhat)
   intentionally ugly. It doesn't use the State monad to hold the DB because it
   hasn't been introduced yet. Perhaps we could use this as an example of How
   Monads Improve Things? -}

module PassDB where

import qualified Data.Map as M
import System.Exit

type UserName = String
type Password = String
type PassDB   = M.Map UserName Password
  -- PassDB is a map from usernames to passwords

-- | Ask the user for a username and new password, and return the new PassDB
changePass :: PassDB -> IO PassDB
changePass db = do
  putStrLn "Enter a username and new password to change."
  putStr "Username: "
  un <- getLine
  putStrLn "New password: "
  pw <- getLine
  if un `M.member` db -- if un is one of the keys of the map
  then return $ M.insert un pw db -- then update the value with the new
password
  else do putStrLn $ "Can't find username '" ++ un ++ "' in the database."
         return db

-- | Ask the user for a username, whose password will be displayed.
viewPass :: PassDB -> IO ()
viewPass db = do
  putStrLn "Enter a username, whose password will be displayed."
  putStr "Username: "
  un <- getLine
  putStrLn $ case M.lookup un db of
    Nothing -> "Can't find username '" ++ un ++ "' in the database."
    Just pw  -> pw

-- | The main loop for interacting with the user.
mainLoop :: PassDB -> IO PassDB
mainLoop db = do
  putStr "Command [cvq]: "
  c <- getChar
  putStr "\n"
  -- See what they want us to do. If they chose a command other than 'q', then
  -- recurse (i.e. ask the user for the next command). We use the Maybe
datatype
  -- to indicate whether to recurse or not: 'Just db' means do recurse, and in
  -- running the command, the old database changed to db. 'Nothing' means don't
  -- recurse.
  db' <- case c of
    'c' -> fmap Just $ changePass db
    'v' -> do viewPass db; return (Just db)
    'q' -> return Nothing
    _   -> do putStrLn $ "Not a recognised command, '" ++ [c] ++ "'."
           return (Just db)
  maybe (return db) mainLoop db'

-- | Parse the file we've just read in, by converting it to a list of lines,
-- then folding down this list, starting with an empty map and adding the
-- username and password for each line at each stage.
parseMap :: String -> PassDB
parseMap = foldr parseLine M.empty . lines
  where parseLine ln map =
        let [un, pw] = words ln
            in M.insert un pw map

```



```
-- | Convert our database to the format we store in the file by first
converting
-- it to a list of pairs, then mapping over this list to put a space between
-- the username and password
showMap :: PassDB -> String
showMap = unlines . map (\(un, pw) -> un ++ " " ++ pw) . M.toList

main :: IO ()
main = do
  putStrLn $ "Welcome to PassDB. Enter a command: (c)hange a password, " ++
            "(v)iew a password or (q)uit."
  dbFile <- readFile "passdb"
  db'     <- mainLoop (parseMap dbFile)
  writeFile "passdb" (showMap db')
```

75 IO

75.1 The IO Library

Here, we'll explore the most commonly used elements of the `System.IO` module.

```
data IOMode = ReadMode | WriteMode
            | AppendMode | ReadWriteMode

openFile :: FilePath -> IOMode -> IO Handle
hClose :: Handle -> IO ()

hIsEOF :: Handle -> IO Bool

hGetChar :: Handle -> IO Char
hGetLine :: Handle -> IO String
hGetContents :: Handle -> IO String

getChar :: IO Char
getLine :: IO String
getContents :: IO String

hPutChar :: Handle -> Char -> IO ()
hPutStr :: Handle -> String -> IO ()
hPutStrLn :: Handle -> String -> IO ()

putChar :: Char -> IO ()
putStr :: String -> IO ()
putStrLn :: String -> IO ()

readFile :: FilePath -> IO String
writeFile :: FilePath -> String -> IO ()
```

Note:

`FilePath` is a *type synonym* for `String`. So, for instance, the `readFile` function takes a `String` (the file to read) and returns an action that, when run, produces the contents of that file. See the *Type declarations^a* chapter for more about type synonyms.

^a Chapter 15 on page 105

Most of the IO functions are self-explanatory. The `openFile` and `hClose` functions open and close a file, respectively. The `IOMode` argument determines the mode for opening the file. `hIsEOF` tests for end-of file. `hGetChar` and `hGetLine` read a character or line (respectively) from a file. `hGetContents` reads the entire file. The `getChar`, `getLine`, and `getContents` variants read from standard input. `hPutChar` prints a character to a file; `hPutStr` prints a string; and `hPutStrLn` prints a string with a newline character at the end. The variants without the `h` prefix work on standard output. The `readFile` and `writeFile` functions read and write an entire file without having to open it first.

75.2 Bracket

The `bracket` function comes from the `Control.Exception` module. It helps perform actions safely.

```
bracket :: IO a -> (a -> IO b) -> (a -> IO c) -> IO c
```

Consider a function that opens a file, writes a character to it, and then closes the file. When writing such a function, one needs to be careful to ensure that, if there were an error at some point, the file is still successfully closed. The `bracket` function makes this easy. It takes three arguments: The first is the action to perform at the beginning. The second is the action to perform at the end, regardless of whether there's an error or not. The third is the action to perform in the middle, which might result in an error. For instance, our character-writing function might look like:

```
writeChar :: FilePath -> Char -> IO ()
writeChar fp c =
  bracket
    (openFile fp WriteMode)
    hClose
    (\h -> hPutChar h c)
```

This will open the file, write the character, and then close the file. However, if writing the character fails, `hClose` will still be executed, and the exception will be reraised afterwards. That way, you don't need to worry too much about catching the exceptions and about closing all of your handles.

75.3 A File Reading Program

We can write a simple program that allows a user to read and write files. The interface is admittedly poor, and it does not catch all errors (such as reading a non-existent file). Nevertheless, it should give a fairly complete example of how to use IO. Enter the following code into "FileRead.hs," and compile/run:

```
import System.IO
import Control.Exception

main = doLoop

doLoop = do
  putStrLn "Enter a command rFN wFN or q to quit:"
  command <- getLine
  case command of
    'q':_ -> return ()
    'r':filename -> do putStrLn ("Reading " ++ filename)
                      doRead filename
                      doLoop
    'w':filename -> do putStrLn ("Writing " ++ filename)
                      doWrite filename
                      doLoop
    _ -> doLoop

doRead filename =
  bracket (openFile filename ReadMode) hClose
    (\h -> do contents <- hGetContents h
              putStrLn "The first 100 chars:"
```

```

        putStrLn (take 100 contents))

doWrite filename = do
  putStrLn "Enter text to go into the file:"
  contents <- getLine
  bracket (openFile filename WriteMode) hClose
    (\h -> hPutStrLn h contents)

```

What does this program do? First, it issues a short string of instructions and reads a command. It then performs a **case** switch on the command and checks first to see if the first character is a 'q.' If it is, it returns a value of unit type.

Note:

The **return** function is a function that takes a value of type **a** and returns an action of type **IO a**. Thus, the type of **return ()** is **IO ()**.

If the first character of the command wasn't a 'q,' the program checks to see if it was an 'r' followed by some string that is bound to the variable **filename**. It then tells you that it's reading the file, does the read and runs **doLoop** again. The check for 'w' is nearly identical. Otherwise, it matches **_**, the wildcard character, and loops to **doLoop**.

The **doRead** function uses the **bracket** function to make sure there are no problems reading the file. It opens a file in **ReadMode**, reads its contents and prints the first 100 characters (the **take** function takes an integer *n* and a list and returns the first *n* elements of the list).

The **doWrite** function asks for some text, reads it from the keyboard, and then writes it to the specified file.

Note:

Both **doRead** and **doWrite** could have been made simpler by using **readFile** and **writeFile**, but they were written in the extended fashion to show how the more complex functions are used.

The program has one major problem: it will die if you try to read a file that doesn't already exist or if you specify some bad filename like ***\bs^#_@**. You may think that the calls to **bracket** in **doRead** and **doWrite** should take care of this, but they don't. They only catch exceptions within the main body, not within the startup or shutdown functions (**openFile** and **hClose**, in these cases). To make this completely reliable, we would need a way to catch exceptions raised by **openFile**.

Exercises:

Write a variation of our program so that it first asks whether the user wants to read from a file, write to a file, or quit. If the user responds with "quit", the program should exit. If they respond with "read", the program should ask them for a file name and then print that file to the screen (if the file doesn't exist, the program may crash). If they respond with "write", it should ask them for a file name and then ask them for text to write to the file, with "." signaling completion. All but the "." should be written to the file.

For example, running this program might produce:

```
Do you want to [read] a file, [write] a file, or [quit]?
read
Enter a file name to read:
foo
...contents of foo...
Do you want to [read] a file, [write] a file, or [quit]?
write
Enter a file name to write:
foo
Enter text (dot on a line by itself to end):
this is some
text for
foo
.
Do you want to [read] a file, [write] a file, or [quit]?
read
Enter a file name to read:
foo
this is some
text for
foo
Do you want to [read] a file, [write] a file, or [quit]?
blech
I don't understand the command blech.
Do you want to [read] a file, [write] a file, or [quit]?
quit
Goodbye!
```

76 Random Numbers

76.1 Random examples

Random numbers have many uses.

Example: Ten random integer numbers

```
import System.Random

main = do
  gen <- newStdGen
  let ns = randoms gen :: [Int]
  print $ take 10 ns
```

The IO action `newStdGen` creates a new `StdGen` pseudorandom number generator state. This `StdGen` can be passed to functions which need to generate pseudorandom numbers.

(There also exists a global random number generator which is initialized automatically in a system dependent fashion. This generator is maintained in the IO monad and can be accessed with `getStdGen`. This is perhaps a library wart, however, as all that you really ever need is `newStdGen`.)

Alternatively, one can use `mkStdGen`:

Example: Ten random floats using `mkStdGen`

```
import System.Random

randomList :: (Random a) => Int -> [a]
randomList seed = randoms (mkStdGen seed)

main :: IO ()
main = do print $ take 10 (randomList 42 :: [Float])
```

Running this script results in output like this:

```
[0.110407025,0.8453985,0.307
7821,0.78138804,0.5242582,0.5196911,0.20084688,0.4794773,0.3240164,6.1566383e-2]
```

Example: Unsorting a list (imperfectly)

```
import Data.List ( sortBy )
import Data.Ord ( comparing )
import System.Random ( Random, RandomGen, randoms, newStdGen )

main :: IO ()
main =
  do gen <- newStdGen
     interact $ unlines . unsort gen . lines

unsort :: (RandomGen g) => g -> [x] -> [x]
unsort g es = map snd . sortBy (comparing fst) $ zip rs es
  where rs = randoms g :: [Integer]
```

There's more to random number generation than `randoms`. For example, you can use `random` (sans 's') to generate a single random number along with a new `StdGen` to be used for the next one. Also, `randomR` and `randomRs` take a parameter for specifying the range. See below for more ideas.

76.2 The Standard Random Number Generator

The Haskell standard random number functions and types are defined in the `System.Random` module. The definition of `random`¹ is a bit tricky to follow because it uses classes to make itself more general.

From the standard:

```
----- The RandomGen class -----
class RandomGen g where
  genRange :: g -> (Int, Int)
  next     :: g -> (Int, g)
  split    :: g -> (g, g)

----- A standard instance of RandomGen -----
data StdGen = ... -- Abstract
```

This basically introduces `StdGen`, the standard random number generator "object". It's an instance of the `RandomGen` class which specifies the operations other pseudorandom number generator libraries need to implement to be used with the `System.Random` library.

Given `r :: StdGen`, you can say:

```
(x, r2) = next r
```

¹ <http://www.haskell.org/onlinereport/random.html>

That gives you a random `Int` `x` and a new `StdGen` `r2`. The `next` function is defined in the `RandomGen` class, and you can apply it to something of type `StdGen` because `StdGen` is an instance of the `RandomGen` class, as below.

From the Standard:

```
instance RandomGen StdGen where ...
instance Read StdGen where ...
instance Show StdGen where ...
```

This also says that you can convert a `StdGen` to and from a string. (The dots are not Haskell syntax; they simply say that the Standard does not define an implementation of these instances.)

From the Standard:

```
mkStdGen :: Int -> StdGen
```

Put in a seed `Int` to the `mkStdGen` function, you'll get out a generator.

As a functional language, Haskell returns a new random number generator with the `next`. In languages with mutable variables, the random number generator routine has the hidden side effect of updating the state of the generator ready for the next call. Haskell won't do that. If you want to generate three random numbers in Haskell, you need to say something like:

```
let
  (x1, r2) = next r
  (x2, r3) = next r2
  (x3, r4) = next r3
```

The random values (`x1`, `x2`, `x3`) are themselves random integers. To get something in the range, say, (0,999) you would have to take the modulus yourself (which is silly). There ought to be a library routine built on this, and indeed there is:

From the Standard:

```
----- The Random class -----
class Random a where
  randomR :: RandomGen g => (a, a) -> g -> (a, g)
  random  :: RandomGen g => g -> (a, g)

  randomRs :: RandomGen g => (a, a) -> g -> [a]
  randoms  :: RandomGen g => g -> [a]

  randomRIO :: (a,a) -> IO a
  randomIO  :: IO a
```

Remember that `StdGen` is the only instance of type `RandomGen` (unless you roll your own random number generator). Therefore, you can substitute `StdGen` for 'g' in the types above and get this:

```
randomR :: (a, a) -> StdGen -> (a, StdGen)
random  :: StdGen -> (a, StdGen)

randomRs :: (a, a) -> StdGen -> [a]
randoms  :: StdGen -> [a]
```

But remember that this is all inside *another* class declaration "Random". This all says: any instance of Random can use these functions. The instances of Random in the Standard are:

```
instance Random Integer where ...
instance Random Float   where ...
instance Random Double  where ...
instance Random Bool    where ...
instance Random Char    where ...
```

So for any of these types you can get a random range. You can get a random integer with:

```
(x1, r2) = randomR (0,999) r
```

And you can get a random upper case character with

```
(c2, r3) = randomR ('A', 'Z') r2
```

You can even get a random bit with

```
(b3, r4) = randomR (False, True) r3
```

So far so good, but threading the random number state through your entire program like this is painful, error prone, and generally destroys the nice clean functional properties of your program.

One partial solution is the "split" function in the RandomGen class. It takes one generator and gives you two generators back. That lets you say something like this:

```
(r1, r2) = split r
x = foo r1
```

In this case, we are passing r1 down into function foo, which does something random with it and returns a result "x". We can then take "r2" as the random number generator for whatever comes next. Without "split" we would have to write

```
(x, r2) = foo r1
```

Yet this too is often clumsy. We can do it the quick and dirty way by putting the whole thing in the IO monad. Thus, we get a standard global random number generator just like any other language.

From the Standard:

```
----- The global random generator -----
newStdGen    :: IO StdGen
setStdGen    :: StdGen -> IO ()
getStdGen    :: IO StdGen
getStdRandom :: (StdGen -> (a, StdGen)) -> IO a
```

We could write:

```
foo :: IO Int
foo = do
  r1 <- getStdGen
  let (x, r2) = randomR (0,999) r1
```

```
setStdGen r2
return x
```

That gets the global generator, uses it, and then updates it (otherwise every random number will be the same). But having to get and update the global generator every time you use it is a pain, so its more common to use `getStdRandom`. The argument to this is a function. Compare the type of that function to that of `'random'` and `'randomR'`. They both fit in rather well. To get a random integer in the IO monad you can say:

```
x <- getStdRandom $ randomR (1,999)
```

The `'randomR (1,999)` has type `StdGen -> (Int, StdGen)`, so it fits straight into the argument required by `getStdRandom`.

76.3 Using QuickCheck to Generate Random Data

Only being able to do random numbers via the IO monad is a bit of a pain. You find that some function deep inside your code needs a random number, and suddenly you have to rewrite half your program as IO actions instead of nice pure functions, or you need a `StdGen` parameter to tramp its way down there through all the higher level functions. We would prefer something a bit purer.

Recall from the State monad² chapter, that patterns like:

```
let
  (x1, r2) = next r
  (x2, r3) = next r2
  (x3, r4) = next r3
```

Can be done with "do" notation:

```
do -- Not real Haskell
  x1 <- random
  x2 <- random
  x3 <- random
```

Of course, you can do this in the IO monad, but it would be better if random numbers had their own little monad that specialized in random computations. And it just so happens that such a monad exists. It lives in the `Test.QuickCheck` module, and it's called `Gen`.

The reason that `Gen` lives in `Test.QuickCheck` is historical: that is where it was invented. The purpose of `QuickCheck` is to generate random unit tests to verify properties of your code. (Incidentally, `QuickCheck` works wonderfully, and most Haskell developers use it for testing). See the Introduction to `QuickCheck`³ on the HaskellWiki for more details. This tutorial will concentrate on using the `Gen` monad for generating random data.

To use `QuickCheck` modules, you will need to install the `QuickCheck` package. With that done, just put

```
import Test.QuickCheck
```

² Chapter 35 on page 219

³ http://www.haskell.org/haskellwiki/Introduction_to_QuickCheck

in your source file.

The `Gen` monad can be thought of as a monad of random computations. As well as generating random numbers, it provides a library of functions that build up complicated values out of simple ones.

So lets start with a routine to return three random integers between 0 and 999:

```
randomTriple :: Gen (Integer, Integer, Integer)
randomTriple = do
  x1 <- choose (0,999)
  x2 <- choose (0,999)
  x3 <- choose (0,999)
  return (x1, x2, x3)
```

`choose` is one of the functions from `QuickCheck`. Its the equivalent to `randomR`.

```
choose :: Random a => (a, a) -> Gen a
```

In other words, for any type "a" which is an instance of "Random" (see above), `choose` will map a range into a generator.

Once you have a `Gen` action you have to execute it.

The `unGen` function executes an action and returns the random result:

```
unGen :: Gen a -> StdGen -> Int -> a
```

The three arguments are:

1. The generator action.
2. A random number generator.
3. The "size" of the result. This isn't used in the example above, but if you were generating a data structure with a variable number of elements (like a list) then this parameter lets you pass some notion of the expected size into the generator. We'll see an example later.

So for example, this generates three arbitrary numbers:

```
let
  triple = unGen randomTriple (mkStdGen 1) 1
```

But the numbers will always be the same because the same seed value is used! If you want *different* numbers then you have to use a different `StdGen` argument.

A common pattern in most programming languages involves a random number generator choosing between two courses of action:

```
-- Not Haskell code
r := random (0,1)
if r == 1 then foo else bar
```

`QuickCheck` provides a more declarative way of doing the same thing. If `foo` and `bar` are both generators returning the same type then we can say:

```
oneof [foo, bar]
```

This has an equal chance of returning either `foo` or `bar`. If you wanted different odds, then you could say something like:

```
frequency [ (30, foo), (70, bar) ]
```

`oneof` takes a simple list of `Gen` actions and selects one of them at random. `frequency` does something similar, but the probability of each item is given by the associated weighting.

```
oneof :: [Gen a] -> Gen a  
frequency :: [(Int, Gen a)] -> Gen a
```

77 General Practices

78 Building a standalone application

Let's build a simple Haskell application, i.e. a piece of standalone software.

78.1 The Main module

The basic requirement behind this is to have a module **Main** with an entry point called **main** and of type `IO ()`.

```
-- thingamie.hs
module Main where

main = putStrLn "Bonjour, world!"
```

We already know how to load this into GHCi, but here's how we compile it and then run it independently:

```
$ ghc --make -o bonjourWorld thingamie.hs
$ ./bonjourWorld
Bonjour, world!
```

Voilà! You now have a standalone application built in Haskell.

78.2 Other modules

Most programs grow to be complicated enough to split across different files. Here is a toy example of an application which uses two modules.

```
-- Hello.hs
module Hello where

hello = "Bonjour, world!"

-- thingamie.hs
module Main where

import Hello

main = putStrLn hello
```

We can compile this fancy new program in the same way as before. The `--make` flag tells GHC to automatically detect dependencies in the files you are compiling. That is, since `thingamie.hs` imports a module `Hello`, GHC will search the Haskell files in the current directory for files that implement `Hello` and also compile them. If `Hello` depends on other modules, GHC will automatically detect those dependencies as well.

```
$ ghc --make -o bonjourWorld thingamie.hs
$ ./bonjourWorld
Bonjour, world!
```

You may have noticed that the file with the `Main` module, `thingamie.hs`, does not have a name matching the module name, which goes against what we said in the [Modules¹](#) chapter. That is not a problem because the point of having matching module and file names is allowing GHC to find the files automatically. Since that process always begins from `Main`, whose file we specify in the command line when calling GHC, the file of the `Main` module need not follow the convention.

If you want to search in other places for source files (including a nested structure of files and directories), you can add the starting point for the dependency search with the `-i` flag. This flag takes multiple, colon-separated directory names as its argument.

As a contrived example, the following program has three files all stored in a `src/` directory. The directory structure looks like:

```
HaskellProgram/
  src/
    Main.hs
    GUI/
      Interface.hs
    Functions/
      Mathematics.hs
```

The `Main` module imports its dependencies by searching a path analogous to the module name — so that `import GUI.Interface` would search for `GUI/Interface` (with the appropriate file extension).

To compile this program from within the `HaskellProgram` directory, invoke GHC with:

```
$ ghc --make -isrc -o sillyprog Main.hs
```

¹ Chapter 22.1 on page 139

79 Debugging

79.1 Debug prints with Debug.Trace

Debug prints are a common way to debug programs. In imperative languages, we can just sprinkle the code with print statements to standard output or to some as log file in order to track debug information (e.g. value of a particular variable, or some human-readable message). In Haskell, however, we cannot output any information other than through the IO monad; and we don't want to introduce that just for debugging.

To deal with this problem, the standard library provides the `Debug.Trace`¹. That module exports a function called `trace` which provides a convenient way to attach debug print statements anywhere in a program. For instance, this program prints every argument passed to `fib` when not equal to 0 or 1:

```
module Main where
import Debug.Trace

fib :: Int -> Int
fib 0 = 0
fib 1 = 1
fib n = trace ("n: " ++ show n) $ fib (n - 1) + fib (n - 2)

main = putStrLn $ "fib 4: " ++ show (fib 4)
```

Below is the resulting output:

```
n: 4
n: 3
n: 2
n: 2
fib 4: 3
```

Also, `trace` makes it possible to trace execution steps of program; that is, which function is called first, second, etc. To do so, we annotate parts of functions we are interested in, like this:

```
module Main where
import Debug.Trace

factorial :: Int -> Int
factorial n | n == 0 = trace ("branch 1") 1
            | otherwise = trace ("branch 2") $ n * (factorial $ n - 1)

main = do
  putStrLn $ "factorial 6: " ++ show (factorial 6)
```

1 <http://hackage.haskell.org/packages/archive/base/latest/doc/html/Debug-Trace.html>

When a program annotated in such way is run, it will print the debug strings in the same order the annotated statements were executed. That output might help to locate errors in case of missing statements or similar things.

79.1.1 Some extra advice

As demonstrated above, `trace` can be used outside of the IO monad; and indeed its type signature...

```
trace :: String -> a -> a
```

...indicates that it is a pure function. Yet surely `trace` *is* doing IO while printing useful messages. What's going on? In fact, `trace` uses a dirty trick of sorts to circumvent the separation between IO and pure Haskell. That is reflected in the following disclaimer, found in the documentation for `trace`²:

The trace function should *only* be used for debugging, or for monitoring execution. The function is not referentially transparent: its type indicates that it is a pure function but it has the side effect of outputting the trace message.

A common mistake in using `trace`: while trying to fit the debug traces into an existing function, one accidentally includes the value being evaluated in the message to be printed by `trace`; e.g. don't do anything like this:

```
let foo = trace ("foo = " ++ show foo) $ bar
in  baz
```

That leads to infinite recursion because trace message will be evaluated before bar expression which will lead to evaluation of foo in terms of trace message and bar again and trace message will be evaluated before bar and so forth to infinity. Instead of `show foo`, the correct trace message should have `show bar`:

```
let foo = trace ("foo = " ++ show bar) $ bar
in  baz
```

79.1.2 Useful idioms

A helper function that incorporates `show` can be convenient:

```
traceThis :: (Show a) => a -> a
traceThis x = trace (show x) x
```

In a similar vein, `Debug.Trace` defines a `traceShow` function, that "prints" its first argument and evaluates to the second one:

```
traceShow :: (Show a) => a -> b -> b
traceShow = trace . show
```

Finally, a function `debug` like this one may prove handy as well:

2 <http://hackage.haskell.org/package/base-4.11.1.0/docs/Debug-Trace.html#v:trace>

```
debug = flip trace
```

This will allow you to write code like...

```
main = (1 + 2) `debug` "adding"
```

... making it easier to comment/uncomment debugging statements.

79.2 Incremental development with GHCi

79.3 Debugging with Hat

79.4 General tips

80 Testing

80.1 Quickcheck

Consider the following function:

```
getList = find 5 where
  find 0 = return []
  find n = do
    ch <- getChar
    if ch `elem` ['a'..'e'] then do
      tl <- find (n-1)
      return (ch : tl) else
    find n
```

How would we effectively test this function in Haskell? We'll use refactoring and QuickCheck.

80.1.1 Keeping things pure

The `getList` function is hard to test because `getChar` does IO out in the world, so there's no internal way to verify things. The other statements in our `do` block are all wrapped up with the IO.

Let's untangle our function so we can at least test the referentially transparent parts with QuickCheck. We can take advantage of lazy IO firstly, to avoid all the unpleasant low-level IO handling.

So the first step is to factor out the IO part of the function into a thin "skin" layer:

```
-- A thin monadic skin layer
getList :: IO [Char]
getList = fmap take5 getContents

-- The actual worker
take5 :: [Char] -> [Char]
take5 = take 5 . filter (`elem` ['a'..'e'])
```

80.1.2 Testing with QuickCheck

Now, we can test the 'guts' of the algorithm, the `take5` function, in isolation. Let's use QuickCheck. First we need an Arbitrary instance for the Char type — that takes care of generating random Chars for us to test with. Restrict it to a range of nice chars just for simplicity:

```
import Data.Char
import Test.QuickCheck
```

```
instance Arbitrary Char where
  arbitrary = choose ('\32', '\128')
  coarbitrary c = variant (ord c `rem` 4)
```

Let's fire up GHCi and try some generic properties (it's nice that we can use the QuickCheck testing framework directly from the Haskell REPL). An easy one first, a `[Char]` is equal to itself:

```
*A> quickCheck ((\s -> s == s) :: [Char] -> Bool)
OK, passed 100 tests.
```

What just happened? QuickCheck generated 100 random `[Char]` values, and applied our property, checking the result was `True` for all cases. QuickCheck *generated the test sets for us!*

A more interesting property now: reversing twice returns the identity:

```
*A> quickCheck ((\s -> (reverse.reverse) s == s) :: [Char] -> Bool)
OK, passed 100 tests.
```

Great!

80.1.3 Testing take5

The first step to testing with QuickCheck is to work out some properties that are true of the function, for all inputs. That is, we need to find *invariants*.

A simple invariant might be: $\forall s. \text{length}(\text{take5 } s) = 5$

So let's write that as a QuickCheck property:

```
\s -> length (take5 s) == 5
```

Which we can then run in QuickCheck as:

```
*A> quickCheck (\s -> length (take5 s) == 5)
Falsifiable, after 0 tests:
""
```

Ah! QuickCheck caught us out. If the input string contains less than 5 filterable characters, the resulting string will be no more than 5 characters long. So let's weaken the property a bit: $\forall s. \text{length}(\text{take5 } s) \leq 5$

That is, `take5` returns a string of at most 5 characters long. Let's test this:

```
*A> quickCheck (\s -> length (take5 s) <= 5)
OK, passed 100 tests.
```

Good!

80.1.4 Another property

Another thing to check would be that the correct characters are returned. That is, for all returned characters, those characters are members of the set ['a','b','c','d','e'].

We can specify that as: $\forall s. \forall e. (e \in \text{take5 } s) \Rightarrow (e \in \{a, b, c, d, e\})$

And in QuickCheck:

```
*A> quickCheck (\s -> all (`elem` ['a'..'e']) (take5 s))
OK, passed 100 tests.
```

Excellent. So we can have some confidence that the function neither returns strings that are too long nor includes invalid characters.

80.1.5 Coverage

One issue with the default QuickCheck configuration, when testing [Char]: the standard 100 tests isn't enough for our situation. In fact, QuickCheck never generates a String greater than 5 characters long when using the supplied Arbitrary instance for Char! We can confirm this:

```
*A> quickCheck (\s -> length (take5 s) < 5)
OK, passed 100 tests.
```

QuickCheck wastes its time generating different Chars, when what we really need is longer strings. One solution to this is to modify QuickCheck's default configuration to test deeper:

```
deepCheck p = check (defaultConfig { configMaxTest = 10000}) p
```

This instructs the system to find at least 10000 test cases before concluding that all is well. Let's check that it is generating longer strings:

```
*A> deepCheck (\s -> length (take5 s) < 5)
Falsifiable, after 125 tests:
";:iD~*NNi~Y\RegMob\DEL@krsx/=dcf7kub|EQi\DELD*"
```

We can check the test data QuickCheck is generating using the 'verboseCheck' hook. Here, testing on integers lists:

```
*A> verboseCheck (\s -> length s < 5)
0: []
1: [0]
2: []
3: []
4: []
5: [1,2,1,1]
6: [2]
7: [-2,4,-4,0,0]
Falsifiable, after 7 tests:
[-2,4,-4,0,0]
```

80.1.6 More information on QuickCheck

- http://haskell.org/haskellwiki/Introduction_to_QuickCheck
- http://haskell.org/haskellwiki/QuickCheck_as_a_test_set_generator

80.2 HUnit

Sometimes it is easier to give an example for a test than to define one from a general rule. HUnit provides a unit testing framework which helps you to do just this. You could also abuse QuickCheck by providing a general rule which just so happens to fit your example; but it's probably less work in that case to just use HUnit.

TODO: give an example of HUnit test, and a small tour of it

More details for working with HUnit can be found in its user's guide¹.

¹ <http://hunit.sourceforge.net/HUnit-1.0/Guide.html>

81 Packaging your software (Cabal)

A guide to the best practice for creating a new Haskell project or program.

81.1 Recommended tools

Almost all new Haskell projects use the following tools. Each is intrinsically useful, but using a set of common tools also benefits everyone by increasing productivity, and you're more likely to get patches.

81.1.1 Revision control

Use darcs¹, unless you have a specific reason not to, in which case use git². If you don't like git, go back and look at darcs. It's written in Haskell, and it's used by many Haskell developers. See the wikibook Understanding darcs³ to get started.

81.1.2 Build system

Use Cabal⁴. You should read at least the start of section 2 of the Cabal User's Guide⁵.

81.1.3 Documentation

For libraries, use Haddock⁶. We recommend using recent versions of haddock (2.8 or above, as of December 2010).

81.1.4 Testing

Pure code can be tested using QuickCheck⁷ or SmallCheck⁸, impure code with HUnit⁹.

1 <http://darcs.net>
2 <http://git-scm.com>
3 <https://en.wikibooks.org/wiki/Understanding%20darcs>
4 <http://haskell.org/cabal>
5 <http://haskell.org/cabal/users-guide/index.html>
6 <http://haskell.org/haddock>
7 <http://www.md.chalmers.se/~rjmh/QuickCheck/>
8 <http://www.mail-archive.com/haskell@haskell.org/msg19215.html>
9 <http://hunit.sourceforge.net/>

To get started, try Haskell/Testing¹⁰. For a slightly more advanced introduction, Simple Unit Testing in Haskell¹¹ is a blog article about creating a testing framework for QuickCheck using some Template Haskell.

81.2 Structure of a simple project

The basic structure of a new Haskell project can be adopted from HNop¹², the minimal Haskell project. It consists of the following files, for the mythical project "haq".

- Haq.hs -- the main haskell source file
- haq.cabal -- the cabal build description
- Setup.hs -- build script itself
- _darcs or .git -- revision control
- README -- info
- LICENSE -- license

You can of course elaborate on this, with subdirectories and multiple modules.

Here is a transcript on how you'd create a minimal darcs-using and cabalised Haskell project, for the cool new Haskell program "haq", build it, install it and release.

The command tool 'cabal init' automates all this for you, but it's important that you understand all the parts first.

We will now walk through the creation of the infrastructure for a simple Haskell executable. Advice for libraries follows after.

81.2.1 Create a directory

Create somewhere for the source:

```
$ mkdir haq
$ cd haq
```

81.2.2 Write some Haskell source

Write your program:

```
$ cat > Haq.hs
--
-- Copyright (c) 2006 Don Stewart - http://www.cse.unsw.edu.au/~dons
-- GPL version 2 or later (see http://www.gnu.org/copyleft/gpl.html)
--
import System.Environment

-- 'main' runs the main program
main :: IO ()
main = getArgs >>= print . haqify . head
```

¹⁰ Chapter 80 on page 563

¹¹ <http://blog.codersbase.com/2006/09/simple-unit-testing-in-haskell.html>

¹² <http://semantic.org/hnop/>

```
haqify s = "Haq! " ++ s
```

81.2.3 Stick it in darcs

Place the source under revision control:

```
$ darcs init
$ darcs add Haq.hs
$ darcs record
addfile ./Haq.hs
Shall I record this change? (1/?) [ynWsfqadjkc], or ? for help: y
hunk ./Haq.hs 1
+--
+-- Copyright (c) 2006 Don Stewart - http://www.cse.unsw.edu.au/~dons
+-- GPL version 2 or later (see http://www.gnu.org/copyleft/gpl.html)
+--
+import System.Environment
+
+-- | 'main' runs the main program
+main :: IO ()
+main = getArgs >>= print . haqify . head
+
+haqify s = "Haq! " ++ s
Shall I record this change? (2/?) [ynWsfqadjkc], or ? for help: y
What is the patch name? Import haq source
Do you want to add a long comment? [yn]n
Finished recording patch 'Import haq source'
```

And we can see that darcs is now running the show:

```
$ ls
Haq.hs _darcs
```

For git:

```
$ git config --global user.name "John Doe"
$ git config --global user.email johndoe@example.com
$ git init
$ git add *
$ git commit -m 'Import haq source'
$ ls -A
.git Haq.hs
```

81.2.4 Add a build system

Create a .cabal file describing how to build your project:

```
$ cat > haq.cabal
Name:             haq
Version:          0.0
Synopsis:         Super cool mega lambdas
Description:      My super cool, indeed, even mega lambdas
                  will demonstrate a basic project. You will marvel.
License:          GPL
License-file:     LICENSE
Author:           Don Stewart
```

```
Maintainer:      Don Stewart <dons@cse.unsw.edu.au>
Build-Depends:   base

Executable:      haq
Main-is:         Haq.hs
```

(If your package uses other packages, e.g. `array`, you'll need to add them to the `Build-Depends` field.) Add a `Setup.lhs` that will actually do the building:

```
$ cat > Setup.lhs
#! /usr/bin/env runhaskell

> import Distribution.Simple
> main = defaultMain
```

Cabal allows either `Setup.hs` or `Setup.lhs`; as long as the format is appropriate, it doesn't matter which one you choose. But it's a good idea to always include the `#! /usr/bin/env runhaskell` line; because it follows the shebang¹³ convention, you could execute the `Setup.hs` directly in a Unix shell instead of always manually calling `runhaskell` (assuming the `Setup` file is marked executable, of course).

Record your changes:

```
$ darcs add haq.cabal Setup.lhs
$ darcs record --all
What is the patch name? Add a build system
Do you want to add a long comment? [yn]n
Finished recording patch 'Add a build system'
```

Git:

```
$ git add haq.cabal Setup.lhs
$ git commit -m 'Add a build system'
```

81.2.5 Build your project

Now build it!

```
$ runhaskell Setup.lhs configure --prefix=$HOME --user
$ runhaskell Setup.lhs build
$ runhaskell Setup.lhs install
```

81.2.6 Run it

And now you can run your cool project:

```
$ haq me
"Haq! me"
```

¹³ <https://en.wikipedia.org/wiki/Shebang%20%28Unix%29>

You can also run it in-place, avoiding the install phase:

```
$ dist/build/haq/haq you
"Haq! you"
```

81.2.7 Build some haddock documentation

Generate some API documentation into `dist/doc/*`

```
$ runhaskell Setup.lhs haddock
```

which generates files in `dist/doc/` including:

```
$ w3m -dump dist/doc/html/haq/Main.html
haq Contents Index
Main

Synopsis
main :: IO ()

Documentation

main :: IO ()
main runs the main program

Produced by Haddock version 0.7
```

No output? Make sure you have actually installed haddock. It is a separate program, not something that comes with the Haskell compiler, like Cabal.

81.2.8 Add some automated testing: QuickCheck

We'll use QuickCheck to specify a simple property of our `Haq.hs` code. Create a tests module, `Tests.hs`, with some QuickCheck boilerplate:

```
$ cat > Tests.hs
import Char
import List
import Test.QuickCheck
import Text.Printf

main = mapM_ (\(s,a) -> printf "%-25s: " s >> a) tests

instance Arbitrary Char where
  arbitrary = choose ('\0', '\128')
  coarbitrary c = variant (ord c `rem` 4)
```

Now let's write a simple property:

```
$ cat >> Tests.hs
-- reversing twice a finite list, is the same as identity
prop_reversereverse s = (reverse . reverse) s == id s
  where _ = s :: [Int]

-- and add this to the tests list
```

```
tests = [("reverse.reverse/id", test prop_reversereverse)]
```

We can now run this test, and have QuickCheck generate the test data:

```
$ runhaskell Tests.hs
reverse.reverse/id      : OK, passed 100 tests.
```

Let's add a test for the 'haqify' function:

```
-- Dropping the "Haq! " string is the same as identity
prop_haq s = drop (length "Haq! ") (haqify s) == id s
  where haqify s = "Haq! " ++ s

tests = [("reverse.reverse/id", test prop_reversereverse)
        ,("drop.haq/id",      test prop_haq)]
```

and let's test that:

```
$ runhaskell Tests.hs
reverse.reverse/id      : OK, passed 100 tests.
drop.haq/id            : OK, passed 100 tests.
```

Great!

81.2.9 Running the test suite from darcs

We can arrange for darcs to run the test suite on every commit:

```
$ darcs setpref test "runhaskell Tests.hs"
Changing value of test from '' to 'runhaskell Tests.hs'
```

will run the full set of QuickChecks. (If your test requires it you may need to ensure other things are built too e.g.: `darcs setpref test "alex Tokens.x;happy Grammar.y;runhaskell Tests.hs"`).

Let's commit a new patch:

```
$ darcs add Tests.hs
$ darcs record --all
What is the patch name? Add testsuite
Do you want to add a long comment? [yn]n
Running test...
reverse.reverse/id      : OK, passed 100 tests.
drop.haq/id            : OK, passed 100 tests.
Test ran successfully.
Looks like a good patch.
Finished recording patch 'Add testsuite'
```

Excellent, now patches must pass the test suite before they can be committed.

81.2.10 Tag the stable version, create a tarball, and sell it!

Tag the stable version:

```
$ darcs tag
What is the version name? 0.0
Finished tagging patch 'TAG 0.0'
```

Advanced Darcs functionality: lazy get

As your repositories accumulate patches, new users can become annoyed at how long it takes to accomplish the initial `darcs get`. (Some projects, like `yi`¹⁴ or `GHC`, can have thousands of patches.) Darcs is quick enough, but downloading thousands of individual patches can still take a while. Isn't there some way to make things more efficient?

Darcs provides the `--lazy` option to `darcs get`. This enables to download only the latest version of the repository. Patches are later downloaded on demand if needed.

Distribution

When distributing your Haskell program, you have roughly three options:

1. distributing via a Darcs repository
2. distributing a tarball
 - a) a Darcs tarball
 - b) a Cabal tarball

With a Darcs repository, if it is public, then you are done. However: perhaps you don't have a server with Darcs, or perhaps your computer isn't set up for people to `darcs pull` from it. In which case you'll need to distribute the source via tarball.

Tarballs via darcs

Darcs provides a command where it will make a compressed tarball, and it will place a copy of all the files it manages into it. (Note that nothing in `_darcs` will be included - it'll just be your source files, no revision history.)

```
$ darcs dist -d haq-0.0
Created dist as haq-0.0.tar.gz
```

And you're all set up!

Tarballs via Cabal

Since our code is cabalised, we can create a tarball with Cabal directly:

```
$ runhaskell Setup.lhs sdist
Building source dist for haq-0.0...
```

¹⁴ <https://en.wikipedia.org/wiki/Yi%20%28editor%29>

```
Source tarball created: dist/haq-0.0.tar.gz
```

This has advantages and disadvantages compared to a Darcs-produced tarball. The primary *advantage* is that Cabal will do more checking of our repository, and more importantly, it'll ensure that the tarball has the structure needed by HackageDB and cabal-install.

However, it does have a disadvantage: it packages up only the files needed to build the project. It will deliberately fail to include other files in the repository, even if they turn out to be necessary at some point¹⁵. To include other files (such as `Test.hs` in the above example), we need to add lines to the cabal file like:

```
extra-source-files: Tests.hs
```

If we had them, we could make sure files like `AUTHORS` or the `README` get included as well:

```
data-files: AUTHORS, README
```

81.2.11 Summary

The following files were created:

```
$ ls
Haq.hs      Tests.hs   dist       haq.cabal
Setup.lhs  _darcs    haq-0.0.tar.gz
```

81.3 Libraries

The process for creating a Haskell library is almost identical. The differences are as follows, for the hypothetical "ltree" library:

81.3.1 Hierarchical source

The source should live under a directory path that fits into the existing module layout guide¹⁶. So we would create the following directory structure, for the module `Data.LTree`:

```
$ mkdir Data
$ cat > Data/LTree.hs
module Data.LTree where
```

¹⁵ This is actually a good thing, since it allows us to do things like create an elaborate test suite which doesn't get included in the tarball, so users aren't bothered by it. It also can reveal hidden assumptions and omissions in our code - perhaps your code was only building and running because of a file accidentally generated.

¹⁶ <http://community.haskell.org/~simonmar/lib-hierarchy.html>

So our `Data.LTree` module lives in `Data/LTree.hs`

81.3.2 The Cabal file

Cabal files for libraries list the publicly visible modules, and have no executable section:

```
$ cat ltree.cabal
Name:             ltree
Version:          0.1
Description:      Lambda tree implementation
License:          BSD3
License-file:     LICENSE
Author:           Don Stewart
Maintainer:       dons@cse.unsw.edu.au
Build-Depends:   base
Exposed-modules:  Data.LTree
```

We can thus build our library:

```
$ runhaskell Setup.lhs configure --prefix=$HOME --user
$ runhaskell Setup.lhs build
Preprocessing library ltree-0.1...
Building ltree-0.1...
[1 of 1] Compiling Data.LTree      ( Data/LTree.hs, dist/build/Data/LTree.o
)
/usr/bin/ar: creating dist/build/libHSLtree-0.1.a
```

and our library has been created as a object archive. On *nix systems, you should probably add the `--user` flag to the configure step (this means you want to update your local package database during installation). Now install it:

```
$ runhaskell Setup.lhs install
Installing: /home/dons/lib/ltree-0.1/ghc-6.6 & /home/dons/bin ltree-0.1...
Registering ltree-0.1...
Reading package info from ".installed-pkg-config" ... done.
Saving old package config file... done.
Writing new package config file... done.
```

And we're done! You can use your new library from, for example, `ghci`:

```
$ ghci -package ltree
Prelude> :m + Data.LTree
Prelude Data.LTree>
```

The new library is in scope, and ready to go.

81.3.3 More complex build systems

For larger projects it is useful to have source trees stored in subdirectories. This can be done simply by creating a directory, for example, `"src"`, into which you will put your `src` tree.

To have Cabal find this code, you add the following line to your Cabal file:

```
hs-source-dirs: src
```

Cabal can set up to also run configure scripts, along with a range of other features. For more information consult the Cabal documentation¹⁷.

Internal modules

If your library uses internal modules that are not exposed, do not forget to list them in the *other-modules* field:

```
other-modules: My.Own.Module
```

Failing to do so (as of GHC 6.8.3) may lead to your library deceptively building without errors but actually being unusable from applications, which would fail at build time with a linker error.

81.4 Automation

81.4.1 cabal init

A package management tool for Haskell called cabal-install provides a command line tool to help developers create a simple cabal project. Just run and answer all the questions. Default values are provided for each.

```
$ cabal init
Package name [default "test"]?
Package version [default "0.1"]?
Please choose a license:
...
```

81.4.2 mkcabal

mkcabal is a tool that existed before cabal init, which also automatically populates a new cabal project :

```
darcs get http://code.haskell.org/~dons/code/mkcabal
```

N.B. This tool does not work in Windows. The Windows version of GHC does not include the readline package that this tool needs.

Usage is:

¹⁷ <http://www.haskell.org/ghc/docs/latest/html/Cabal/index.html>

```
$ mkcabal
Project name: haq
What license ["GPL","LGPL","BSD3","BSD4","PublicDomain","AllRightsReserved"]
["BSD3"]:
What kind of project [Executable,Library] [Executable]:
Is this your name? - "Don Stewart " [Y/n]:
Is this your email address? - "<dons@cse.unsw.edu.au>" [Y/n]:
Created Setup.lhs and haq.cabal
$ ls
Haq.hs    LICENSE  Setup.lhs _darcs  dist      haq.cabal
```

which will fill out some stub Cabal files for the project 'haq'.

To create an entirely new project tree:

```
$ mkcabal --init-project
Project name: haq
What license ["GPL","LGPL","BSD3","BSD4","PublicDomain","AllRightsReserved"]
["BSD3"]:
What kind of project [Executable,Library] [Executable]:
Is this your name? - "Don Stewart " [Y/n]:
Is this your email address? - "<dons@cse.unsw.edu.au>" [Y/n]:
Created new project directory: haq
$ cd haq
$ ls
Haq.hs    LICENSE  README  Setup.lhs haq.cabal
```

81.5 Licenses

Code for the common base library package must be BSD licensed or something more Free/Open. Otherwise, it is entirely up to you as the author.

Choose a licence (inspired by this¹⁸). Check the licences of things you use, both other Haskell packages and C libraries, since these may impose conditions you must follow.

Use the same licence as related projects, where possible. The Haskell community is split into 2 camps, roughly, those who release everything under BSD or public domain, and the GPL/LGPLers (this split roughly mirrors the copyleft/noncopyleft divide in Free software communities). Some Haskellers recommend specifically avoiding the LGPL, due to cross module optimisation issues. Like many licensing questions, this advice is controversial. Several Haskell projects (wxHaskell, HaXml, etc.) use the LGPL with an extra permissive clause to avoid the cross-module optimisation problem.

81.6 Releases

It's important to release your code as stable, tagged tarballs. Don't just rely on darcs for distribution¹⁹.

- **darcs dist** generates tarballs directly from a darcs repository

¹⁸ <http://www.dina.dk/~abraham/rants/license.html>

¹⁹ <http://web.archive.org/web/20070627103346/http://awayrepl.blogspot.com/2006/11/we-dont-do-releases.html>

For example:

```
$ cd fps
$ ls
Data      LICENSE  README   Setup.hs  TODO      _darcs   cbits dist
fps.cabal tests
$ darcs dist -d fps-0.8
Created dist as fps-0.8.tar.gz
```

You can now just post your `fps-0.8.tar.gz`

You can also have darcs do the equivalent of 'daily snapshots' for you by using a post-hook. put the following in `_darcs/prefs/defaults`:

```
apply posthook darcs dist
apply run-posthook
```

Advice:

- Tag each release using `darcs tag`. For example:

```
$ darcs tag 0.8
Finished tagging patch 'TAG 0.8'
```

Then people can `darcs get --lazy --tag 0.8`, to get just the tagged version (and not the entire history).

81.7 Hosting

You can host public and private Darcs repositories on <http://patch-tag.com/> for free. Otherwise, a Darcs repository can be published simply by making it available from a web page. Another option is to host on the Haskell Community Server at <http://code.haskell.org/>. You can request an account via <http://community.haskell.org/admin/>. You can also use <https://github.com/> for Git hosting.

81.8 Example

A complete example²⁰ of writing, packaging and releasing a new Haskell library under this process has been documented.

²⁰ <http://www.cse.unsw.edu.au/~dons/blog/2006/12/11#release-a-library-today>

82 Using the Foreign Function Interface (FFI)

Using Haskell is fine, but in the real world there are a large number of useful libraries in other languages, especially C. To use these libraries, and let C code use Haskell functions, there is the Foreign Function Interface (FFI).

82.1 Calling C from Haskell

82.1.1 Marshalling (Type Conversion)

When using C functions, it is necessary to convert Haskell types to the appropriate C types. These are available in the `Foreign.C.Types` module; some examples are given in the following table.

Haskell	Foreign.C.Types	C
Double	CDouble	double
Char	CUChar	unsigned char
Int	CLong	long int

The operation of converting Haskell types into C types is called **marshalling** (and the opposite, predictably, *unmarshalling*). For basic types this is quite straightforward: for floating-point one uses `realToFrac` (either way, as e.g. both `Double` and `CDouble` are instances of classes `Real` and `Fractional`), for integers `fromIntegral`, and so on.

Warning

If you are using GHC previous to 6.12.x, note that the `CLDouble` type does not really represent a long double, but is just a synonym for `CDouble`: *never use it*, since it will lead to silent type errors if the C compiler does not also consider `long double` a synonym for `double`. Since 6.12.x `CLDouble` has been removed¹, pending proper implementation².

82.1.2 Calling a pure C function

A pure function implemented in C does not present significant trouble in Haskell. The `sin` function of the C standard library is a fine example:

```
{-# LANGUAGE ForeignFunctionInterface #-}
```

```
import Foreign
import Foreign.C.Types

foreign import ccall unsafe "math.h sin"
  c_sin :: CDouble -> CDouble
```

First, we specify a GHC extension for the FFI in the first line. We then import the `Foreign` and `Foreign.C.Types` modules, the latter of which contains information about `CDouble`, the representation of double-precision floating-point numbers in C.

We then specify that we are *importing* a *foreign* function, with a call to C. A "safety level" has to be specified with the keyword `safe` (the default) or `unsafe`. In general, `unsafe` is more efficient, and `safe` is required only for C code that could call back a Haskell function. Since that is a very particular case, it is actually quite safe to use the `unsafe` keyword in most cases. Finally, we need to specify header and function name, separated by a space.

The Haskell function name is then given, in our case we use a standard `c_sin`, but it could have been anything. Note that the function signature must be correct—GHC will not check the C header to confirm that the function actually takes a `CDouble` and returns another, and writing a wrong one could have unpredictable results.

It is then possible to generate a wrapper around the function using `CDouble` so that it looks exactly like any Haskell function.

```
haskellSin :: Double -> Double
haskellSin = realToFrac . c_sin . realToFrac
```

Importing C's `sin` is simple because it is a pure function that takes a plain `double` as input and returns another as output: things will complicate with impure functions and pointers, which are ubiquitous in more complicated C libraries.

82.1.3 Impure C Functions

A classic impure C function is `rand`, for the generation of pseudo-random numbers. Suppose you do not want to use Haskell's `System.Random.randomIO`, for example because you want to replicate exactly the series of pseudo-random numbers output by some C routine. Then, you could import it just like `sin` before:

```
{-# LANGUAGE ForeignFunctionInterface #-}

import Foreign
import Foreign.C.Types

foreign import ccall unsafe "stdlib.h rand"
  c_rand :: CUInt -- oops!
```

If you try this naïve implementation in GHCI, you will notice that `c_rand` is returning always the same value:

```
> c_rand
1714636915
> c_rand
1714636915
```

indeed, we have told GHC that it is a pure function, and GHC sees no point in calculating twice the result of a pure function. Note that GHC did not give any error or warning message.

In order to make GHC understand this is no pure function, we have to use the IO monad³:

```
{-# LANGUAGE ForeignFunctionInterface #-}

import Foreign
import Foreign.C.Types

foreign import ccall unsafe "stdlib.h rand"
  c_rand :: IO CUInt

foreign import ccall "stdlib.h srand"
  c_srand :: CUInt -> IO ()
```

Here, we also imported the `srand` function, to be able to seed the C pseudo-random generator.

```
> c_rand
1957747793
> c_rand
424238335
> c_srand 0
> c_rand
1804289383
> c_srand 0
> c_rand
1804289383
```

82.1.4 Working with C Pointers

The most useful C functions are often those that do complicated calculations with several parameters, and with increasing complexity the need of returning control codes arises. This means that a typical paradigm of C libraries is to give pointers of allocated memory as "targets" in which the results may be written, while the function itself returns an integer value (typically, if 0, computation was successful, otherwise there was a problem specified by the number). Another possibility is that the function will return a pointer to a structure (possibly defined in the implementation, and therefore unavailable to us).

As a pedagogical example, we consider the `gsl_frexp` function⁴ of the GNU Scientific Library⁵, a freely available library for scientific computation. It is a simple C function with prototype:

```
double gsl_frexp (double x, int * e)
```

The function takes a `double` x , and it returns its normalised fraction f and integer exponent e so that:

³ Chapter 34 on page 213

⁴ http://www.gnu.org/software/gsl/manual/html_node/Elementary-Functions.html

⁵ http://en.wikipedia.org/wiki/GNU_Scientific_Library

$$x = f \times 2^e \quad e \in \mathbb{Z}, \quad 0.5 \leq f < 1$$

We interface this C function into Haskell with the following code:

```
{-# LANGUAGE ForeignFunctionInterface #-}

import Foreign
import Foreign.Ptr
import Foreign.C.Types

foreign import ccall unsafe "gsl/gsl_math.h gsl_frexp"
  gsl_frexp :: CDouble -> Ptr CInt -> IO CDouble
```

The new part is `Ptr`, which can be used with any instance of the `Storable` class, among which all C types, but also several Haskell types.

Notice how the result of the `gsl_frexp` function is in the `IO` monad. This is typical when working with pointers, be they used for input or output (as in this case); we will see shortly what would happen had we used a simple `CDouble` for the function.

The `frexp` function is implemented in pure Haskell code as follows:

```
frexp :: Double -> (Double, Int)
frexp x = unsafePerformIO $
  alloca $ \expPtr -> do
    f <- gsl_frexp (realToFrac x) expPtr
    e <- peek expPtr
    return (realToFrac f, fromIntegral e)
```

We know that, memory management details aside, the function is pure: that's why the signature returns a tuple with f and e outside of the `IO` monad. Yet, f is provided *inside* of it: to extract it, we use the function `unsafePerformIO`, which extracts values from the `IO` monad: obviously, it is legitimate to use it only when we *know* the function is pure, and we can allow GHC to optimise accordingly.

To allocate pointers, we use the `alloca` function, which also takes responsibility for freeing memory. As an argument, `alloca` takes a function of type `Ptr a -> IO b`, and returns the `IO b`. In practice, this translates to the following usage pattern with λ functions:

```
... alloca $ \pointer -> do
  c_function argument pointer
  result <- peek pointer
  return result
```

The pattern can easily be nested if several pointers are required:

```
... alloca $ \firstPointer ->
  alloca $ \secondPointer -> do
    c_function argument firstPointer secondPointer
    first <- peek firstPointer
    second <- peek secondPointer
    return (first, second)
```

Back to our `frexp` function: in the λ function that is the argument to `alloca`, the function is evaluated and the pointer is read immediately afterwards with `peek`. Here we can understand why we wanted the imported C function `gsl_frexp` to return a value in the `IO` monad: if GHC could decide when to calculate the quantity f , it would likely decide not

to do it until it is necessary: that is at the last line when `return` uses it, and *after* `e` has been read from an allocated, but yet uninitialised memory address, which will contain random data. In short, we want `gsl_frexp` to return a monadic value because we want to determine the sequence of computations ourselves.

If some other function had required a pointer to *provide input* instead of storing output, one would have used the similar `poke` function to set the pointed value, obviously *before* evaluating the function:

```
... alloca $ \inputPointer ->
    alloca $ \outputPointer -> do
        poke inputPointer value
        c_function argument inputPointer outputPointer
        result <- peek outputPointer
        return result
```

In the final line, the results are arranged in a tuple and returned, after having been converted from C types.

To test the function, remember to link GHC to the GSL; in GHCI, do:

```
$ ghci frexp.hs -lgsl
```

(Note that most systems do not come with the GSL preinstalled, and you may have to download and install its development packages.)

82.1.5 Working with C Structures

Very often data are returned by C functions in form of `structs` or pointers to these. In some rare cases, these structures are returned directly, but more often they are returned as pointers; the return value is most often an `int` that indicates the correctness of execution.

We will consider another GSL function, `gsl_sf_bessel_Jn_e`⁶. This function provides the regular cylindrical Bessel function for a given order `n`, and returns the result as a `gsl_sf_result` structure pointer. The structure contains two `doubles`, one for the result and one for the error. The integer error code returned by the function can be transformed in a C string by the function `gsl_strerror`. The signature of the Haskell function we are looking for is therefore:

```
BesselJn :: Int -> Double -> Either String (Double, Double)
```

where the first argument is the order of the cylindrical Bessel function, the second is the function's argument, and the returned value is either an error message or a tuple with result and margin of error.

⁶ http://www.gnu.org/software/gsl/manual/html_node/Regular-Cylindrical-Bessel-Functions.html

Making a New Instance of the `Storable` class

In order to allocate and read a pointer to a `gsl_sf_result` structure, it is necessary to make it an instance of the `Storable` class.

In order to do that, it is useful to use the `hsc2hs` program: we create first a `Bessel.hsc` file, with a mixed syntax of Haskell and C macros, which is later expanded into Haskell by the command:

```
$ hsc2hs Bessel.hsc
```

After that, we simply load the `Bessel.hs` file in GHC.

This is the first part of file `Bessel.hsc`:

```
{-# LANGUAGE ForeignFunctionInterface #-}

module Bessel (besselJn) where

import Foreign
import Foreign.Ptr
import Foreign.C.String
import Foreign.C.Types

#include <gsl/gsl_sf_result.h>

data GslSfResult = GslSfResult { gsl_value :: CDouble, gsl_error :: CDouble }

instance Storable GslSfResult where
  sizeOf _ = (#size gsl_sf_result)
  alignment _ = alignment (undefined :: CDouble)
  peek ptr = do
    value <- (#peek gsl_sf_result, val) ptr
    error <- (#peek gsl_sf_result, err) ptr
    return GslSfResult { gsl_value = value, gsl_error = error }
  poke ptr (GslSfResult value error) = do
    (#poke gsl_sf_result, val) ptr value
    (#poke gsl_sf_result, err) ptr error
```

We use the `#include` directive to make sure `hsc2hs` knows where to find information about `gsl_sf_result`. We then define a Haskell data structure mirroring the GSL's, with two `CDoubles`: this is the class we make an instance of `Storable`. Strictly, we need only `sizeOf`, `alignment` and `peek` for this example; `poke` is added for completeness.

- `sizeOf` is obviously fundamental to the allocation process, and is calculated by `hsc2hs` with the `#size` macro.
- `alignment` is the size in bytes of the data structure alignment⁷. In general, it should be the largest `alignment` of the elements of the structure; in our case, since the two elements are the same, we simply use `CDouble`'s. The value of the argument to `alignment` is inconsequential, what is important is the type of the argument.
- `peek` is implemented using a `do`-block and the `#peek` macros, as shown. `val` and `err` are the names used for the structure fields in the GSL source code.
- Similarly, `poke` is implemented with the `#poke` macro.

⁷ http://en.wikipedia.org/wiki/Data_structure_alignment

Importing the C Functions

```
foreign import ccall unsafe "gsl/gsl_bessel.h gsl_sf_bessel_Jn_e"
  c_besselJn :: CInt -> CDouble -> Ptr GslSfResult -> IO CInt

foreign import ccall unsafe "gsl/gsl_errno.h gsl_set_error_handler_off"
  c_deactivate_gsl_error_handler :: IO ()

foreign import ccall unsafe "gsl/gsl_errno.h gsl_strerror"
  c_error_string :: CInt -> IO CString
```

We import several functions from the GSL libraries: first, the Bessel function itself, which will do the actual work. Then, we need a particular function, `gsl_set_error_handler_off`, because the default GSL error handler will simply crash the program, even if called by Haskell: we, instead, plan to deal with errors ourselves. The last function is the GSL-wide interpreter that translates error codes in human-readable C strings.

Implementing the Bessel Function

Finally, we can implement the Haskell version of the GSL cylindrical Bessel function of order n .

```
besselJn :: Int -> Double -> Either String (Double, Double)
besselJn n x = unsafePerformIO $
  alloca $ \gslSfPtr -> do
    c_deactivate_gsl_error_handler
    status <- c_besselJn (fromIntegral n) (realToFrac x) gslSfPtr
    if status == 0
    then do
      GslSfResult val err <- peek gslSfPtr
      return $ Right (realToFrac val, realToFrac err)
    else do
      error <- c_error_string status
      error_message <- peekCString error
      return $ Left ("GSL error: "++error_message)
```

Again, we use `unsafePerformIO` because the function is pure, even though its nuts-and-bolts implementation is not. After allocating a pointer to a GSL result structure, we deactivate the GSL error handler to avoid crashes in case something goes wrong, and finally we can call the GSL function. At this point, if the `status` returned by the function is 0, we unmarshal the result and return it as a tuple. Otherwise, we call the GSL error-string function, and pass the error as a `Left` result instead.

Examples

Once we are finished writing the `Bessel.hsc` function, we have to convert it to proper Haskell and load the produced file:

```
$ hsc2hs Bessel.hsc
$ ghci Bessel.hs -lgsl
```

We can then call the Bessel function with several values:

```
> besselJn 0 10
Right (-0.2459357644513483,1.8116861737200453e-16)
> besselJn 1 0
Right (0.0,0.0)
> besselJn 1000 2
Left "GSL error: underflow"
```

82.1.6 Advanced Topics

This section contains an advanced example with some more complex features of the FFI. We will import into Haskell one of the more complicated functions of the GSL, the one used to calculate the integral of a function between two given points with an adaptive Gauss-Kronrod algorithm⁸. The GSL function is `gsl_integration_qag`.

This example will illustrate function pointers, export of Haskell functions to C routines, enumerations, and handling pointers of unknown structures.

Available C Functions and Structures

The GSL has three functions which are necessary to integrate a given function with the considered method:

```
gsl_integration_workspace * gsl_integration_workspace_alloc (size_t n);
void gsl_integration_workspace_free (gsl_integration_workspace * w);
int gsl_integration_qag (const gsl_function * f, double a, double b,
                        double epsabs, double epsrel, size_t limit,
                        int key, gsl_integration_workspace * workspace,
                        double * result, double * abserr);
```

The first two deal with allocation and deallocation of a "workspace" structure of which we know nothing (we just pass a pointer around). The actual work is done by the last function, which requires a pointer to a workspace.

To provide functions, the GSL specifies an appropriate structure for C:

```
struct gsl_function
{
    double (* function) (double x, void * params);
    void * params;
};
```

The reason for the void pointer is that it is not possible to define λ functions in C: parameters are therefore passed along with a parameter of unknown type. In Haskell, we do not need the `params` element, and will consistently ignore it.

Imports and Inclusions

We start our `qag.hsc` file with the following:

```
{-# LANGUAGE ForeignFunctionInterface, EmptyDataDecls #-}
```

⁸ http://www.gnu.org/software/gsl/manual/html_node/QAG-adaptive-integration.html

```

module Qag ( qag,
             gauss15,
             gauss21,
             gauss31,
             gauss41,
             gauss51,
             gauss61 ) where

import Foreign
import Foreign.Ptr
import Foreign.C.Types
import Foreign.C.String

#include <gsl/gsl_math.h>
#include <gsl/gsl_integration.h>

foreign import ccall unsafe "gsl/gsl_errno.h gsl_strerror"
  c_error_string :: CInt -> IO CString

foreign import ccall unsafe "gsl/gsl_errno.h gsl_set_error_handler_off"
  c_deactivate_gsl_error_handler :: IO ()

```

We declare the `EmptyDataDecls` pragma, which we will use later for the `Workspace` data type. Since this file will have a good number of functions that should not be available to the outside world, we also declare it a module and export only the final function `qag` and the `gauss-` flags. We also include the relevant C headers of the GSL. The import of C functions for error messages and deactivation of the error handler was described before.

Enumerations

One of the arguments of `gsl_integration_qag` is `key`, an integer value that can have values from 1 to 6 and indicates the integration rule. GSL defines a macro for each value, but in Haskell it is more appropriate to define a type, which we call `IntegrationRule`. Also, to have its values automatically defined by `hsc2hs`, we can use the `enum` macro:

```

newtype IntegrationRule = IntegrationRule { rule :: CInt }
#{enum IntegrationRule, IntegrationRule,
   gauss15 = GSL_INTEG_GAUSS15,
   gauss21 = GSL_INTEG_GAUSS21,
   gauss31 = GSL_INTEG_GAUSS31,
   gauss41 = GSL_INTEG_GAUSS41,
   gauss51 = GSL_INTEG_GAUSS51,
   gauss61 = GSL_INTEG_GAUSS61
}

```

`hsc2hs` will search the headers for the macros and give our variables the correct values. The `enum` directive will define a function with an appropriate type signature for each of the enum values. The above example will get translated to something like this (with the C macros appropriately replaced by their values):

```

newtype IntegrationRule = IntegrationRule { rule :: CInt }

gauss15 :: IntegrationRule
gauss15 = IntegrationRule GSL_INTEG_GAUSS15
gauss21 :: IntegrationRule
gauss21 = IntegrationRule GSL_INTEG_GAUSS21
.
.
.

```

The variables cannot be modified and are essentially constant flags. Since we did not export the `IntegrationRule` constructor in the module declaration, but only the `gauss` flags, it is impossible for a user to even construct an invalid value. One thing less to worry about!

Haskell Function Target

We can now write down the signature of the function we desire:

```
qag :: IntegrationRule
    -> Int
    -> Double
    -> Double
    -> (Double -> Double)
    -> Double
    -> Double
    -> Either String (Double, Double)
-- Algorithm type
-- Step limit
-- Absolute tolerance
-- Relative tolerance
-- Function to integrate
-- Integration interval start
-- Integration interval end
-- Result and (absolute) error estimate
```

Note how the order of arguments is different from the C version: indeed, since C does not have the possibility of partial application, the ordering criteria are different than in Haskell.

As in the previous example, we indicate errors with a `Either String (Double, Double)` result.

Passing Haskell Functions to the C Algorithm

```
type CFunction = CDouble -> Ptr () -> CDouble

data GslFunction = GslFunction (FunPtr CFunction) (Ptr ())
instance Storable GslFunction where
    sizeOf _ = (#size gsl_function)
    alignment _ = alignment (undefined :: Ptr ())
    peek ptr = do
        function <- (#peek gsl_function, function) ptr
        return $ GslFunction function nullPtr
    poke ptr (GslFunction fun nullPtr) = do
        (#poke gsl_function, function) ptr fun

makeCfunction :: (Double -> Double) -> (CDouble -> Ptr () -> CDouble)
makeCfunction f = \x voidpointer -> realToFrac $ f (realToFrac x)

foreign import ccall "wrapper"
    makeFunPtr :: CFunction -> IO (FunPtr CFunction)
```

We define a shorthand type, `CFunction`, for readability. Note that the void pointer has been translated to a `Ptr ()`, since we have no intention of using it. Then it is the turn of the `gsl_function` structure: no surprises here. Note that the void pointer is always assumed to be null, both in `peek` and in `poke`, and is never really read nor written.

To make a Haskell `Double -> Double` function available to the C algorithm, we make two steps: first, we re-organise the arguments using a λ function in `makeCfunction`; then, in `makeFunPtr`, we take the function with reordered arguments and produce a function pointer that we can pass on to `poke`, so we can construct the `GslFunction` data structure.

Handling Unknown Structures

```
data Workspace
```



```

foreign import ccall unsafe "gsl/gsl_integration.h
gsl_integration_workspace_alloc"
  c_qag_alloc :: CSize -> IO (Ptr Workspace)
foreign import ccall unsafe "gsl/gsl_integration.h
gsl_integration_workspace_free"
  c_qag_free  :: Ptr Workspace -> IO ()

foreign import ccall safe "gsl/gsl_integration.h gsl_integration_qag"
  c_qag :: Ptr GslFunction -- Allocated GSL function structure
        -> CDouble -- Start interval
        -> CDouble -- End interval
        -> CDouble -- Absolute tolerance
        -> CDouble -- Relative tolerance
        -> CSize   -- Maximum number of subintervals
        -> CInt    -- Type of Gauss-Kronrod rule
        -> Ptr Workspace -- GSL integration workspace
        -> Ptr CDouble -- Result
        -> Ptr CDouble -- Computation error
        -> IO CInt -- Exit code

```

The reason we imported the `EmptyDataDecls` pragma is this: we are declaring the data structure `Workspace` without providing any constructor. This is a way to make sure it will always be handled as a pointer, and never actually instantiated.

Otherwise, we normally import the allocating and deallocating routines. We can now import the integration function, since we have all the required pieces (`GslFunction` and `Workspace`).

The Complete Function

It is now possible to implement a function with the same functionality as the GSL's QAG algorithm.

```

qag gauss steps abstol reltol f a b = unsafePerformIO $ do
  c_deactivate_gsl_error_handler
  workspacePtr <- c_qag_alloc (fromIntegral steps)
  if workspacePtr == nullPtr
  then
    return $ Left "GSL could not allocate workspace"
  else do
    fPtr <- makeFunPtr $ makeCfunction f
    alloca $ \gsl_f -> do
      poke gsl_f (GslFunction fPtr nullPtr)
      alloca $ \resultPtr -> do
        alloca $ \errorPtr -> do
          status <- c_qag gsl_f
            (realToFrac a)
            (realToFrac b)
            (realToFrac abstol)
            (realToFrac reltol)
            (fromIntegral steps)
            (rule gauss)
            workspacePtr
            resultPtr
            errorPtr
          c_qag_free workspacePtr
          freeHaskellFunPtr fPtr
          if status /= 0
          then do
            c_errormsg <- c_error_string status
            errormsg <- peekCString c_errormsg
            return $ Left errormsg
          else do

```

```
c_result <- peek resultPtr
c_error <- peek errorPtr
let result = realToFrac c_result
let error = realToFrac c_error
return $ Right (result, error)
```

First and foremost, we deactivate the GSL error handler, that would crash the program instead of letting us report the error.

We then proceed to allocate the workspace; notice that, if the returned pointer is null, there was an error (typically, too large size) that has to be reported.

If the workspace was allocated correctly, we convert the given function to a function pointer and allocate the `GslFunction` struct, in which we place the function pointer. Allocating memory for the result and its error margin is the last thing before calling the main routine.

After calling, we have to do some housekeeping and free the memory allocated by the workspace and the function pointer. Note that it would be possible to skip the bookkeeping using `ForeignPtr`, but the work required to get it to work is more than the effort to remember one line of cleanup.

We then proceed to check the return value and return the result, as was done for the Bessel function.

82.1.7 Self-Deallocating Pointers

In the previous example, we manually handled the deallocation of the GSL integration workspace, a data structure we know nothing about, by calling its C deallocation function. It happens that the same workspace is used in several integration routines, which we may want to import in Haskell.

Instead of replicating the same allocation/deallocation code each time, which could lead to memory leaks when someone forgets the deallocation part, we can provide a sort of "smart pointer", which will deallocate the memory when it is not needed any more. This is called `ForeignPtr` (do not confuse with `Foreign.Ptr`: this one's qualified name is actually `Foreign.ForeignPtr`!). The function handling the deallocation is called the *finalizer*.

In this section we will write a simple module to allocate GSL workspaces and provide them as appropriately configured `ForeignPtr`s, so that users do not have to worry about deallocation.

The module, written in file `GSLWorkspace.hs`, is as follows:

```
{-# LANGUAGE ForeignFunctionInterface, EmptyDataDecls #-}

module GSLWorkSpace (Workspace, createWorkspace) where

import Foreign.C.Types
import Foreign.Ptr
import Foreign.ForeignPtr

data Workspace
foreign import ccall unsafe "gsl/gsl_integration.h"
  gsl_integration_workspace_alloc
  c_ws_alloc :: CSize -> IO (Ptr Workspace)
foreign import ccall unsafe "gsl/gsl_integration.h"
  &gsl_integration_workspace_free"
```

```

c_ws_free  :: FunPtr( Ptr Workspace -> IO () )

createWorkspace :: CSize -> IO (Maybe (ForeignPtr Workspace) )
createWorkspace size = do
  ptr <- c_ws_alloc size
  if ptr /= nullPtr
  then do
    foreignPtr <- newForeignPtr c_ws_free ptr
    return $ Just foreignPtr
  else
    return Nothing

```

We first declare our empty data structure `Workspace`, just like we did in the previous section.

The `gsl_integration_workspace_alloc` and `gsl_integration_workspace_free` functions will no longer be needed in any other file: here, note that the deallocation function is called with an ampersand ("`&`"), because we do not actually want the function, but rather a *pointer* to it to set as a finalizer.

The workspace creation function returns a `IO (Maybe)` value, because there is still the possibility that allocation is unsuccessful and the null pointer is returned. The GSL does not specify what happens if the deallocation function is called on the null pointer, so for safety we do not set a finalizer in that case and return `IO Nothing`; the user code will then have to check for "Just-ness" of the returned value.

If the pointer produced by the allocation function is non-null, we build a foreign pointer with the deallocation function, inject into the `Maybe` and then the `IO` monad. That's it, the foreign pointer is ready for use!

Warning

This function requires object code to be compiled, so if you load this module with `GHCI` (which is an interpreter) you must indicate it:

```
$ ghci GSLWorkSpace.hs -fobject-code
```

Or, from within `GHCI`:

```
> :set -fobject-code
> :load GSLWorkSpace.hs
```

The `qag.hsc` file must now be modified to use the new module; the parts that change are:

```

{-# LANGUAGE ForeignFunctionInterface #-}

-- [...]

import GSLWorkSpace

import Data.Maybe(isNothing, fromJust)

-- [...]

qag gauss steps abstol reltol f a b = unsafePerformIO $ do
  c_deactivate_gsl_error_handler
  ws <- createWorkspace (fromIntegral steps)
  if isNothing ws

```

```
    then
      return $ Left "GSL could not allocate workspace"
    else do
      withForeignPtr (fromJust ws) $ \workspacePtr -> do
-- [...]

```

Obviously, we do not need the `EmptyDataDecls` extension here any more; instead we import the `GSLWorkspace` module, and also a couple of nice-to-have functions from `Data.Maybe`. We also remove the foreign declarations of the workspace allocation and deallocation functions.

The most important difference is in the main function, where we (try to) allocate a workspace `ws`, test for its `Justness`, and if everything is fine we use the `withForeignPtr` function to extract the workspace pointer. Everything else is the same.

82.2 Calling Haskell from C

Sometimes it is also convenient to call Haskell from C, in order to take advantage of some of Haskell's features which are tedious to implement in C, such as lazy evaluation.

We will consider a typical Haskell example, Fibonacci numbers. These are produced in an elegant, haskellian one-liner as:

```
fibonacci = 0 : 1 : zipWith (+) fibonacci (tail fibonacci)
```

Our task is to export the ability to calculate Fibonacci numbers from Haskell to C. However, in Haskell, we typically use the `Integer` type, which is unbounded: this cannot be exported to C, since there is no such corresponding type. To provide a larger range of outputs, we specify that the C function shall output, whenever the result is beyond the bounds of its integer type, an approximation in floating-point. If the result is also beyond the range of floating-point, the computation will fail. The status of the result (whether it can be represented as a C integer, a floating-point type or not at all) is signalled by the status integer returned by the function. Its desired signature is therefore:

```
int fib( int index, unsigned long long* result, double* approx )
```

82.2.1 Haskell Source

The Haskell source code for file `fibonacci.hs` is:

```
{-# LANGUAGE ForeignFunctionInterface #-}

module Fibonacci where

import Foreign
import Foreign.C.Types

fibonacci :: (Integral a) => [a]
fibonacci = 0 : 1 : zipWith (+) fibonacci (tail fibonacci)

foreign export ccall fibonacci_c :: CInt -> Ptr CULLong -> Ptr CDouble -> IO
  CInt
fibonacci_c :: CInt -> Ptr CULLong -> Ptr CDouble -> IO CInt
```

```

fibonacci_c n intPtr dblPtr
| badInt && badDouble = return 2
| badInt             = do
    poke dblPtr dbl_result
    return 1
| otherwise          = do
    poke intPtr (fromIntegral result)
    poke dblPtr dbl_result
    return 0
where
result      = fibonacci !! (fromIntegral n)
dbl_result  = realToFrac result
badInt      = result > toInteger (maxBound :: CULLong)
badDouble   = isInfinite dbl_result

```

When exporting, we need to wrap our functions in a module (it is a good habit anyway). We have already seen the Fibonacci infinite list, so let's focus on the exported function: it takes an argument, two pointers to the target `unsigned long long` and `double`, and returns the status in the IO monad (since writing on pointers is a side effect).

The function is implemented with input guards, defined in the `where` clause at the bottom. A successful computation will return 0, a partially successful 1 (in which we still can use the floating-point value as an approximation), and a completely unsuccessful one will return 2.

Note that the function does not call `alloca`, since the pointers are assumed to have been already allocated by the calling C function.

The Haskell code can then be compiled with GHC:

```
ghc -c fibonacci.hs
```

82.2.2 C Source

The compilation of `fibonacci.hs` has spawned several files, among which `fibonacci_stub.h`, which we include in our C code in file `fib.c`:

```

#include <stdio.h>
#include <stdlib.h>
#include "fibonacci_stub.h"

int main(int argc, char *argv[]) {
    if (argc < 2) {
        printf("Usage: %s <number>\n", argv[0]);
        return 2;
    }

    hs_init(&argc, &argv);

    const int arg = atoi(argv[1]);
    unsigned long long res;
    double approx;
    const int status = fibonacci_c(arg, &res, &approx);

    hs_exit();
    switch (status) {
    case 0:
        printf("F_%d: %llu\n", arg, res);
        break;
    case 1:

```

```
        printf("Error: result is out of bounds\n");
        printf("Floating-point approximation: %e\n", approx);
        break;
    case 2:
        printf("Error: result is out of bounds\n");
        printf("Floating-point approximation is infinite\n");
        break;
    default:
        printf("Unknown error: %d\n", status);
    }
}

return status;
}
```

The notable thing is that we need to initialise the Haskell environment with `hs_init`, which we call passing it the command-line arguments of `main`; we also have to shut Haskell down with `hs_exit()` when we are done. The rest is fairly standard C code for allocation and error handling.

Note that you have to compile the C code *with GHC*, not your C compiler!

```
ghc -no-hs-main fib.c fibonacci.o fibonacci_stub.o -o fib
```

You can then proceed to test the algorithm:

```
./fib 42
F_42: 267914296
$ ./fib 666
Error: result is out of bounds
Floating-point approximation: 6.859357e+138
$ ./fib 1492
Error: result is out of bounds
Floating-point approximation is infinite
./fib -1
fib: Prelude.(!!): negative index
```

83 Generic Programming : Scrap your boilerplate

The "Scrap your boilerplate" approach, "described" in <http://www.cs.vu.nl/boilerplate/>, is a way to allow your data structures to be traversed by so-called "generic" functions: that is, functions that abstract over the specific data constructors being created or modified, while allowing for the addition of cases for specific types.

For instance if you want to serialize all the structures in your code, but you want to write only one serialization function that operates over any instance of the `Data.Data.Data` class (which can be derived with `-XDeriveDataTypeable`).

83.1 Serialization Example

The goal is to convert all our data into a format below:

```
data Tag = Con String | Val String
```

83.2 Comparing Haskell ASTs

The `haskell-src-extends` package¹ parses Haskell into a quite complicated syntax tree. Let's say we want to check if two source files that are nearly identical are equivalent.

To start:

```
import System.Environment
import Language.Haskell.Exts

main = do
  -- parse the filenames given by the first two command line arguments,
  -- proper error handling is left as an exercise
  [ParseOk moduleA, ParseOk moduleB] <- mapM parseFile . take 2 =<< getArgs

  putStrLn $ if moduleA == moduleB
             then "Your modules are equal"
             else "Your modules differ"
```

From a bit of testing, it will be apparent that identical files with different names will not be equal to (`==`). However, to correct the fact, without resorting to lots of boilerplate, we can use generic programming:

¹ <http://hackage.haskell.org/package/haskell-src-extends>

83.3 TODO

describe using `Data.Generics.Twins.gzip*`? to write a function to find where there are differences?

Or use it to write a variant of `geq` that ignores the specific cases that are unimportant (the `SrcLoc` elements) (i.e. `syb` doesn't allow generic extension... contrast it with other libraries?).

Or just explain this hack (which worked well enough) to run before `(==)`, or `geq::`

```
everyWhere (mkT $ \ _ -> SrcLoc "" 0 0) :: Data a => a -> a
```

Or can we develop this into writing something better than `sim_mira` (for `hs` code), found here: http://dickgrune.com/Programs/similarity_tester/

84 Specialised Tasks

85 Graphical user interfaces (GUI)

Haskell has at least four toolkits for programming a graphical interface:

- wxHaskell¹ - provides a Haskell interface to the cross-platform wxWidgets toolkit which supports Windows, OS X, and Gtk+ on GNU/Linux, among others.
- Gtk2Hs² - provides a Haskell interface to the GTK+ library
- hoc³ (documentation at sourceforge⁴) - provides a Haskell to Objective-C binding which allows users to access to the Cocoa library on MacOS X
- qtHaskell⁵ - provides a set of Haskell bindings for the Qt Widget Library

In this tutorial, we will focus on the wxHaskell toolkit.

85.1 Getting and running wxHaskell

To install wxHaskell, look for your version of instructions at: GNU/Linux⁶ Mac⁷ Windows⁸ or the wxHaskell download page⁹ and follow the installation instructions provided on the wxHaskell download page. Don't forget to register wxHaskell with GHC, or else it won't run (automatically registered with Cabal). To compile source.hs (which happens to use wxHaskell code), open a command line and type:

```
ghc -package wx source.hs -o bin
```

Code for GHCi is similar:

```
ghci -package wx
```

You can then load the files from within the GHCi interface. To test if everything works, go to \$wxHaskellDir/samples/wx (\$wxHaskellDir is the directory where you installed it) and load (or compile) HelloWorld.hs. It should show a window with title "Hello World!", a menu bar with File and About, and a status bar at the bottom, that says "Welcome to wxHaskell".

1 <https://en.wikibooks.org/wiki/%3Aw%3AwxHaskell>
2 <http://www.haskell.org/haskellwiki/Gtk2Hs>
3 <http://code.google.com/p/hoc/>
4 <http://hoc.sourceforge.net/>
5 <http://qthaskell.berlios.de/>
6 <http://www.haskell.org/haskellwiki/WxHaskell/Linux>
7 <http://www.haskell.org/haskellwiki/WxHaskell/Mac>
8 <http://www.haskell.org/haskellwiki/WxHaskell/Windows>
9 <http://wxhaskell.sourceforge.net/download.html>

If it doesn't work, you might try to copy the contents of the `$wxHaskellDir/lib` directory to the `ghc` install directory.

85.1.1 Shortcut for Debian and Ubuntu

If your operating system is Debian or Ubuntu, you can simply run these commands from the terminal:

```
sudo apt-get install g++
sudo apt-get install libglu-dev
sudo apt-get install libwxgtk2.8-dev
```

85.2 Hello World

Here's the basic Haskell "Hello World" program:

```
module Main where

main :: IO ()
main = putStrLn "Hello World!"
```

It will compile just fine, but how do we actually do GUI work with this? First, you must import the `wxHaskell` library `Graphics.UI.WX`. `Graphics.UI.WXCore` has some more stuff, but we won't need that now.

To start a GUI, use `start gui`. In this case, `gui` is the name of a function which we'll use to build the interface. It must have an `IO` type. Let's see what we have:

```
module Main where

import Graphics.UI.WX

main :: IO ()
main = start gui

gui :: IO ()
gui = do
  --GUI stuff
```

To make a frame, we use `frame` which has the type `[Prop (Frame ())] -> IO (Frame ())`. It takes a list of "frame properties" and returns the corresponding frame. We'll look deeper into properties later, but a property is typically a combination of an attribute and a value. What we're interested in now is the title. This is in the `text` attribute and has type `(Textual w) => Attr w String`. The most important thing here, is that it's a `String` attribute. Here's how we code it:

```
gui :: IO (Frame ())
gui = do
  frame [text := "Hello World!"]
```

The operator `(:=)` takes an attribute and a value and combines both into a property. Note that `frame` returns an `IO (Frame ())`. The `start` function has the type `IO a -> IO ()`. You can change the type of `gui` to `IO (Frame ())`, but it might be better just to add

`return ()`. Now we have our own GUI consisting of a frame with title "Hello World!". Its source:

```
module Main where

import Graphics.UI.WX

main :: IO ()
main = start gui

gui :: IO ()
gui = do
  frame [text := "Hello World!"]
  return ()
```

The result should look like the screenshot. (It might look slightly different on Linux or MacOS X, on which wxhaskell also runs)

85.3 Controls

Information

From here on, its good practice to keep a browser window or tab open with the wxHaskell documentation¹⁰. It's also available in `$wxHaskellDir/doc/index.html`.

85.3.1 A text label

A simple frame doesn't do much. In this section, we're going to add some more elements. Let's start simple with a label. wxHaskell has a `label`, but that's a layout thing. We won't be doing layout until next section. What we're looking for is a `staticText`. It's in `Graphics.UI.WX.Controls`. The `staticText` function takes a `Window` as argument along with a list of properties. Do we have a window? Yup! Look at `Graphics.UI.WX.Frame`. There, we see that a `Frame` is merely a type-synonym of a special sort of window. We'll change the code in `gui` so it looks like this:

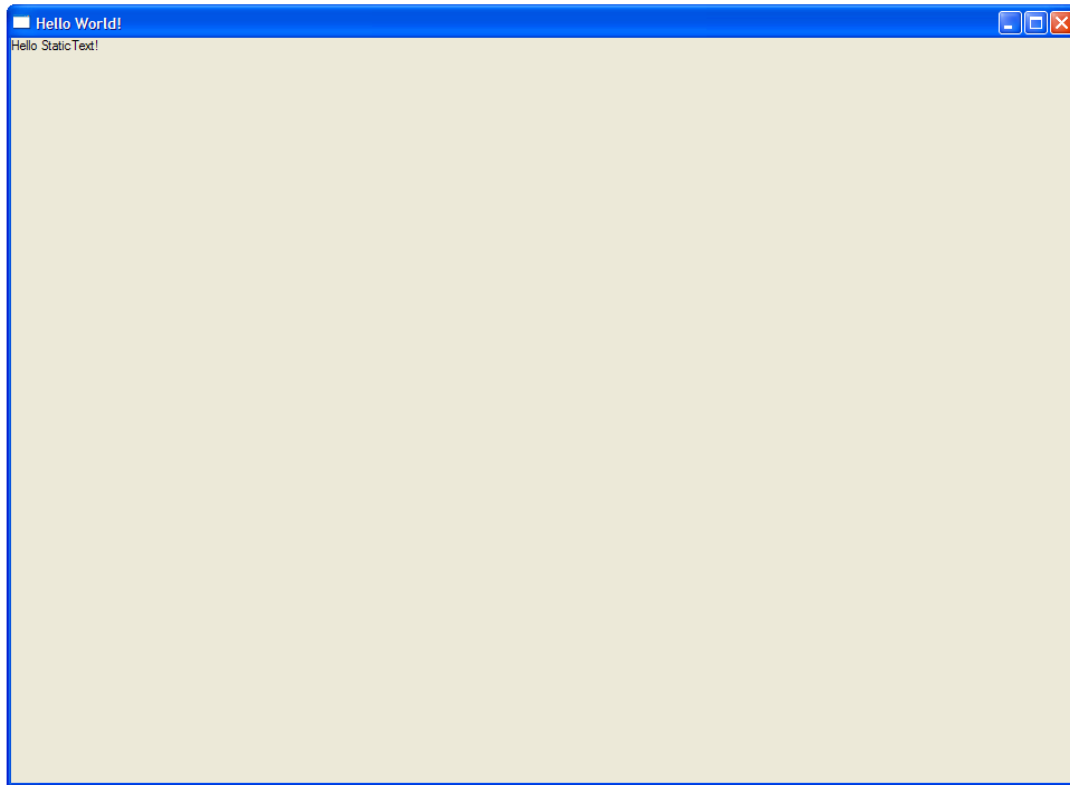

Figure 37 Hello StaticText! (winXP)

```
gui :: IO ()
gui = do
  f <- frame [text := "Hello World!"]
  staticText f [text := "Hello StaticText!"]
  return ()
```

Again, `text` is an attribute of a `staticText` object, so this works. Try it!

85.3.2 A button

Now for a little more interaction. A button. We're not going to add functionality to it until the section about events, but already something visible will happen when you click on it.

A `button` is a control, just like `staticText`. Look it up in `Graphics.UI.WX.Controls`.

Again, we need a window and a list of properties. We'll use the `frame` again. `text` is also an attribute of a `button`:

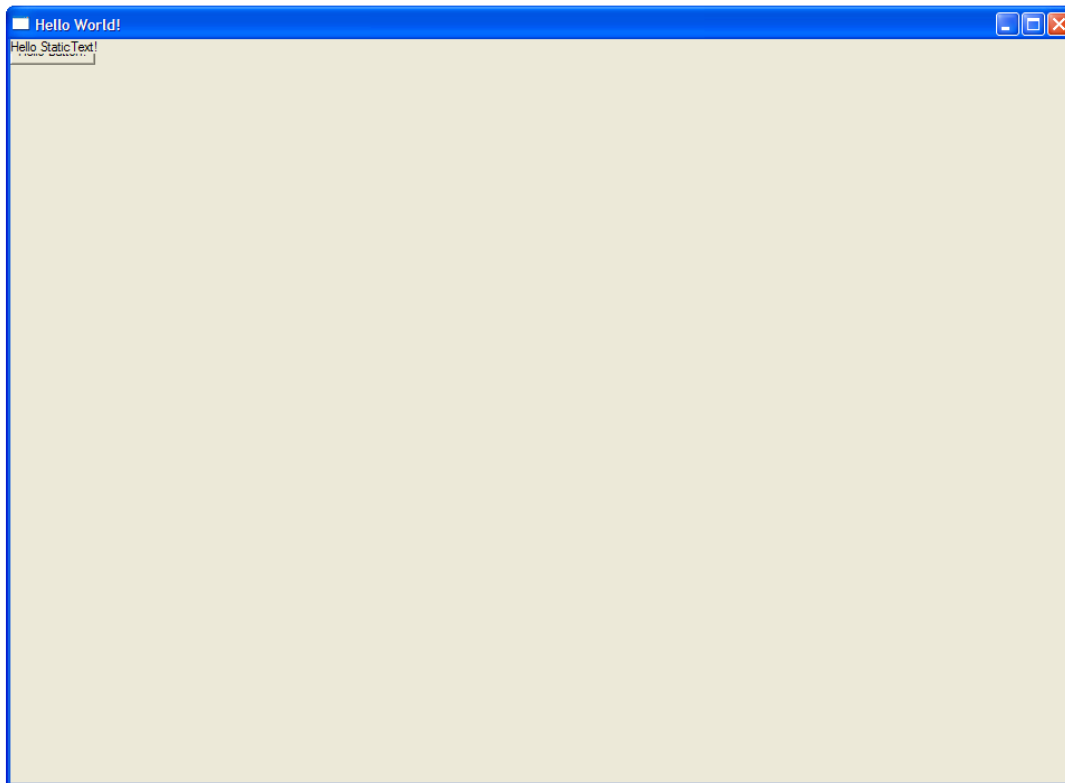

Figure 38 Overlapping button and StaticText (winXP)

```
gui :: IO ()
gui = do
  f <- frame [text := "Hello World!"]
  staticText f [text := "Hello StaticText!"]
  button f [text := "Hello Button!"]
  return ()
```

Load it into GHCi (or compile it with GHC) and... hey!? What's that? The button's been covered up by the label! We're going to fix that next.

85.4 Layout

The reason that the label and the button overlap, is that we haven't set a *layout* for our frame yet. Layouts are created using the functions found in the documentation of `Graphics.UI.WXCore.Layout`. Note that you don't have to import `Graphics.UI.WXCore` to use layouts.

The documentation says we can turn a member of the widget class into a layout by using the `widget` function. Also, windows are a member of the widget class. But, wait a minute... we only have one window, and that's the frame! Nope... we have more, look at `Graphics.UI.WX.Controls` and click on any occurrence of the word *Control*. You'll be taken to `Graphics.UI.WXCore.WxcClassTypes`, and it is there we see that a `Control` is also

a type synonym of a special type of window. We'll need to change the code a bit, but here it is.

```
gui :: IO ()
gui = do
  f <- frame [text := "Hello World!"]
  st <- staticText f [text := "Hello StaticText!"]
  b <- button f [text := "Hello Button!"]
  return ()
```

Now we can use `widget st` and `widget b` to create a layout of the `staticText` and the button. `layout` is an attribute of the frame, so we'll set it here:



Figure 39 StaticText with layout (winXP)

```
gui :: IO ()
gui = do
  f <- frame [text := "Hello World!"]
  st <- staticText f [text := "Hello StaticText!"]
  b <- button f [text := "Hello Button!"]
  set f [layout := widget st]
  return ()
```

The `set` function will be covered in the section below about attributes. Try the code, what's wrong? This only displays the `staticText`, not the button. We need a way to combine the two. We will use *layout combinators* for that. `row` and `column` look nice. They take an integer and a list of layouts. We can easily make a list of layouts of the button and the `staticText`. The integer is the spacing between the elements of the list. Let's try something:



Figure 40 A row layout (winXP)



Figure 41 Column layout with a spacing of 25 (winXP)

```
gui :: IO ()
gui = do
  f <- frame [text := "Hello World!"]
  st <- staticText f [text := "Hello StaticText!"]
  b <- button f [text := "Hello Button!"]
  set f [layout :=
```

```
    row 0 [widget st, widget b]
  ]
  return ()
```

Play around with the integer and see what happens. Also, change `row` into `column`. Try to change the order of the elements in the list to get a feeling of how it works. For fun, try to add `widget b` several more times in the list. What happens?

Here are a few exercises to spark your imagination. Remember to use the documentation!

Exercises:

1. Add a checkbox control. It doesn't have to do anything yet, just make sure it appears next to the `staticText` and the button when using `row`-layout, or below them when using `column` layout. `text` is also an attribute of the checkbox.
2. Notice that `row` and `column` take a list of *layouts*, and also generates a layout itself. Use this fact to make your checkbox appear on the left of the `staticText` and the button, with the `staticText` and the button in a `column`.
3. Can you figure out how the radiobox control works? Take the layout of the previous exercise and add a radiobox with two (or more) options below the checkbox, `staticText` and button. Use the documentation!
4. Use the `boxed` combinator to create a nice looking border around the four controls, and another one around the `staticText` and the button. (*Note: the `boxed` combinator might not be working on MacOS X - you might get widgets that can't be interacted with. This is likely just a bug in wxhaskell.*)

After having completed the exercises, the end result should look like this:

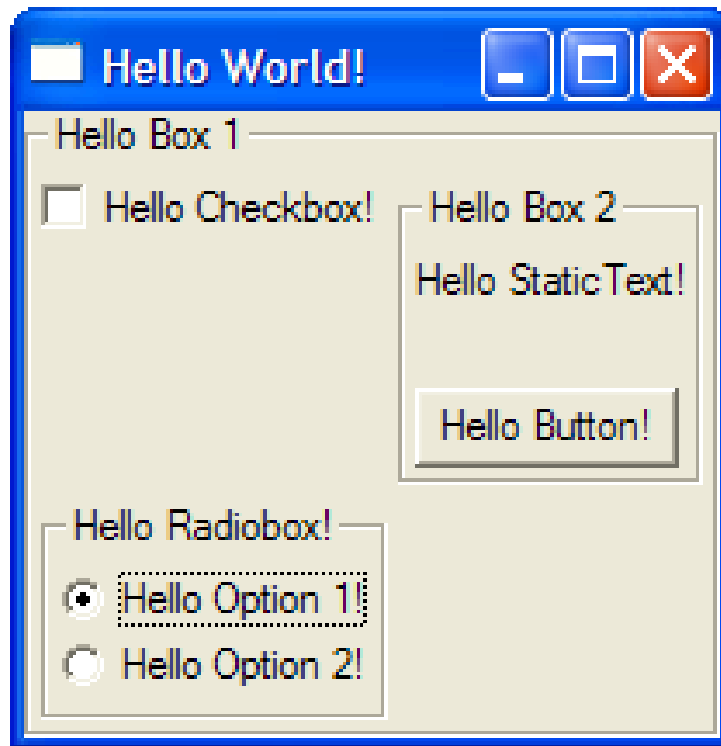

Figure 42 Answer to exercises

You could have used different spacing for row and column or have the options of the radiobox displayed horizontally.

85.5 Attributes

After all this, you might be wondering: "Where did that `set` function suddenly come from?" and "How would I know if `text` is an attribute of something?". Both answers lie in the attribute system of wxHaskell.

85.5.1 Setting and modifying attributes

In a wxHaskell program, you can set the properties of the widgets in two ways:

1. during creation: `f <- frame [text := "Hello World!"]`
2. using the `set` function: `set f [layout := widget st]`

The `set` function takes two arguments: something of type `w` along with properties of `w`. In `wxHaskell`, these will be the widgets and the properties of these widgets. Some properties can only be set during creation, such as the `alignment` of a `textEntry`, but you can set most others in any IO-function in your program — as long as you have a reference to it (the `f` in `set f [stuff]`).

Apart from setting properties, you can also get them. This is done with the `get` function. Here's a silly example:

```
gui :: IO ()
gui = do
  f <- frame [ text := "Hello World!" ]
  st <- staticText f []
  ftext <- get f text
  set st [ text := ftext ]
  set f [ text := ftext ++ " And hello again!" ]
```

Look at the type signature of `get`. It's `w -> Attr w a -> IO a`. `text` is a `String` attribute, so we have an `IO String` which we can bind to `ftext`. The last line edits the text of the frame. Yep, destructive updates are possible in `wxHaskell`. We can overwrite the properties using `(:=)` anytime with `set`. This inspires us to write a modify function:

```
modify :: w -> Attr w a -> (a -> a) -> IO ()
modify w attr f = do
  val <- get w attr
  set w [ attr := f val ]
```

First it gets the value, then it sets it again after applying the function. Surely we're not the first one to think of that...

Look at this operator: `(:~)`. You can use it in `set` because it takes an attribute and a function. The result is a property in which the original value is modified by the function. That means we can write:

```
gui :: IO ()
gui = do
  f <- frame [ text := "Hello World!" ]
  st <- staticText f []
  ftext <- get f text
  set st [ text := ftext ]
  set f [ text :~ ++ " And hello again!" ]
```

This is a great place to use anonymous functions with the lambda-notation.

There are two more operators we can use to set or modify properties: `(::=)` and `(:~)`. They do almost the same as `(:=)` and `(:~)` except a function of type `w -> orig` is expected, where `w` is the widget type, and `orig` is the original "value" type (`a` in case of `(::=)` and `a -> a` in case of `(:~)`). We won't be using them now, as we've only encountered attributes of non-IO types, and the widget needed in the function is generally only useful in IO-blocks.

85.5.2 How to find attributes

Now the second question. Where do we go to determine that `text` is an attribute of all those things? Go to the documentation...

Let's see what attributes a button has: Go to `Graphics.UI.WX.Controls`¹¹. Click the link that says "Button"¹². You'll see that a `Button` is a type synonym of a special kind of `Control`, and a list of functions that can be used to create a button. After each function, there's a list of "Instances". For the normal `button` function, we see *Commanding -- Textual, Literate, Dimensions, Colored, Visible, Child, Able, Tipped, Identity, Styled, Reactive, Paint*. That's the list of classes of which a button is an instance. Read through the `./Classes and types`/¹³ chapter. It means that there are some class-specific functions available for the button. `Textual`, for example, adds the `text` and `appendText` functions. If a widget is an instance of the `Textual` class, it means that it has a `text` attribute!

Note that while `StaticText` hasn't got a list of instances, it's still a `Control`, and that's a synonym for some kind of `Window`. When looking at the `Textual` class, it says that `Window` is an instance of it. That's an error on the side of the documentation!

Let's take a look at the attributes of a frame. They can be found in `Graphics.UI.WX.Frame`. Another error in the documentation here: It says `Frame` instantiates `HasImage`. This was true in an older version of `wxHaskell`. It should say `Pictured`. Apart from that, we have `Form`, `Textual`, `Dimensions`, `Colored`, `Able` and a few more. We're already seen `Textual` and `Form`. Anything that is an instance of `Form` has a `layout` attribute.

`Dimensions` adds (among others) the `clientSize` attribute. It's an attribute of the `Size` type, which can be made with `sz`. Please note that the `layout` attribute can also change the size. If you want to use `clientSize` you should set it after the `layout`.

`Colored` adds the `color` and `bgcolor` attributes.

`Able` adds the Boolean `enabled` attribute. This can be used to enable or disable certain form elements, which is often displayed as a greyed-out option.

There are lots of other attributes, read through the documentation for each class.

85.6 Events

There are a few classes that deserve special attention. They are the `Reactive` class and the `Commanding` class. As you can see in the documentation of these classes, they don't add attributes (of the form `Attr w a`), but *events*. The `Commanding` class adds the `command` event. We'll use a button to demonstrate event handling.

Here's a simple GUI with a button and a `staticText`:

¹¹ <http://hackage.haskell.org/packages/archive/wx/0.10.2/doc/html/Graphics-UI-WX-Controls.html>

¹² <http://hackage.haskell.org/packages/archive/wx/0.10.2/doc/html/Graphics-UI-WX-Controls.html#4>

¹³ Chapter 26 on page 165

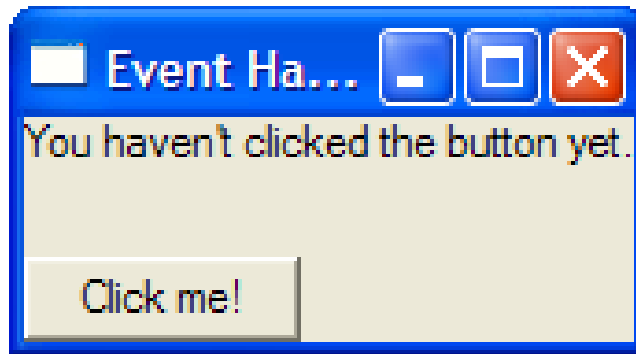

Figure 43 Before (winXP)

```
gui :: IO ()
gui = do
  f <- frame [ text := "Event Handling" ]
  st <- staticText f [ text := "You haven't clicked the button yet." ]
  b <- button f [ text := "Click me!" ]
  set f [ layout := column 25 [ widget st, widget b ] ]
```

We want to change the staticText when you press the button. We'll need the on function:

```
b <- button f [ text := "Click me!"
               , on command := --stuff
               ]
```

The type of on: `Event w a -> Attr w a`. `command` is of type `Event w (IO ())`, so we need an IO-function. This function is called the *Event handler*. Here's what we get:

```
gui :: IO ()
gui = do
  f <- frame [ text := "Event Handling" ]
  st <- staticText f [ text := "You haven't clicked the button yet." ]
  b <- button f [ text := "Click me!"
                , on command := set st [ text := "You have clicked the button!" ]
  ]
  set f [ layout := column 25 [ widget st, widget b ] ]
```

Insert text about event filters here

86 Databases

86.1 Introduction

Haskell's most popular database module is `HDBC`¹. `HDBC` provides an abstraction layer between Haskell programs and SQL relational databases. This lets you write database code once, in Haskell, and have it work with a number of backend SQL databases.

`HDBC` is modeled loosely on Perl's `DBI` interface², though it has also been influenced by Python's `DB-API v2`, `JDBC` in Java, and `HSQL` in Haskell. Like how `DBI` requires `DBD` in Perl, `HDBC` requires a driver module beneath it to work.

These `HDBC` backend drivers exist: `PostgreSQL`, `SQLite`, and `ODBC` (for Windows and Unix/Linux/Mac). `MySQL` is the most popular open-sourced databases, and there are two drivers for `MySQL`: `HDBC-mysql`³ (native) and `HDBC-odbc`⁴ (`ODBC`). `MySQL` users can use the `ODBC` driver on any `MySQL`-supported platform, including Linux.

An advantage of using `ODBC` is that the syntax of the SQL statement is insulated from the different kinds of database engines. This increases the portability of the application should you have to move from one database to another. The same argument for preferring `ODBC` applies for other commercial databases (such as Oracle and `DB2`).

86.2 Installation

86.2.1 PostgreSQL or SQLite

See the `HDBC` `FAQ`⁵ for more information.

86.2.2 Native MySQL

The native `ODBC-mysql` library requires the C `MySQL` client library to be present.

You may need to wrap your database accesses⁶ to prevent runtime errors.

1 <https://github.com/hdbc/hdbc/wiki>

2 <http://search.cpan.org/~timb/DBI/DBI.pm>

3 <http://hackage.haskell.org/package/HDBC-mysql>

4 <http://hackage.haskell.org/package/HDBC-odbc>

5 <https://github.com/hdbc/hdbc/wiki/FrequentlyAskedQuestions>

6 <http://www.serpentine.com/blog/2010/09/04/dealing-with-fragile-c-libraries-e-g-mysql-from-haskell/>

86.2.3 ODBC/MySQL

Making HDBC work with MySQL via ODBC is somewhat involved, especially if you do not have root privileges.

- If your platform doesn't already provide an ODBC library (and most do), install Unix-ODBC. See here⁷ for more information.
- Install MySQL-ODBC Connector. See here⁸ for more information.
- Install Database.HDBC module
- Install Database.HDBC.ODBC module
- Add the mysql driver to odbcinst.ini file (under \$ODBC_HOME/etc/) and your data source in \$HOME/.odbc.ini.
- Create a test program

Since the ODBC driver is installed using shared library by default, you will need the following env:

```
export LD_LIBRARY_PATH=$ODBC_HOME/lib
```

If you do not like adding an additional env variables, you should try to compile ODBC with static library option enabled.

The next task is to write a simple test program that connects to the database and print the names of all your tables, as shown below.

You may need to wrap your database accesses⁹ in order to prevent runtime errors.

```
module Main where
import Database.HDBC.ODBC
import Database.HDBC
main =
  do c <- connectODBC "DSN=PSPDSN"
     xs <- getTables c
     putStr $ "tables "++(foldr jn "." xs)++"\n"
  where jn a b = a++" "++b
```

86.3 General Workflow

86.3.1 Connect and Disconnect

The first step of any database operation is to connect to the target database. This is done via the driver-specific connect API, which has the type of:

```
String -> IO Connection
```

Given a connect string, the connect API will return `Connection` and put you in the IO monad.

⁷ <http://sourceforge.net/projects/unixodbc/>

⁸ <http://dev.mysql.com/downloads/connector/odbc/>

⁹ <http://www.serpentine.com/blog/2010/09/04/dealing-with-fragile-c-libraries-e-g-mysql-from-haskell/>

Although most programs will garbage-collect your connections when they are out of scope or when the program ends, it is a good practice to disconnect from the database explicitly.

```
conn->Disconnect
```

86.3.2 Running Queries

Running a query generally involves the following steps:

- Prepare a statement
- Execute a statement with bind variables
- Fetch the result set (if any)
- Finish the statement

HDBC provides two ways for bind variables and returning result set: [`SqlValue`] and [`Maybe String`]. You need to use the functions with `s` prefix when using [`Maybe String`], instead of [`SqlValue`]. [`SqlValue`] allows you to use strongly typed data if type safety is very important in your application; otherwise, [`Maybe String`] is more handy when dealing with lots of database queries. When you use [`Maybe String`], you assume the database driver will perform automatic data conversion. Be aware there is a performance price for this convenience.

Sometimes, when the query is simple, there are simplified APIs that wrap multiple steps into one. For example, **Run** and **sRun** are wrappers of "prepare and execute". **quickQuery** is a wrapper of "prepare, execute, and fetch all rows".

86.4 Running SQL Statements

86.4.1 Select

86.4.2 Insert

86.4.3 Update

86.4.4 Delete

86.5 Transaction

Database transaction is controlled by `commit` and `rollback`. However, be aware some databases (such as `mysql`) do not support transaction. Therefore, every query is in its atomic transaction.

HDBC provides `withTransaction` to allow you automate the transaction control over a group of queries.

86.6 Calling Procedure

87 Web programming

An example web application, using the HAppS framework, is `hpaste`¹, the Haskell paste bin. Built around the core Haskell web framework, HAppS, with HaXML for page generation, and binary/zlib for state serialisation.

The HTTP and Browser modules² exist, and might be useful.

UNKNOWN TEMPLATE BOOKCATEGORY /Not in book³

¹ <http://hpaste.org>
² <http://homepages.paradise.net.nz/warrickg/haskell/http/>
³ <https://en.wikibooks.org/wiki/%2FNot%20in%20book>

88 Working with XML

There are several Haskell libraries for XML work, and additional ones for HTML. For more web-specific work, you may want to refer to the Haskell/Web programming¹ chapter.

88.0.1 Libraries for parsing XML

- The Haskell XML Toolbox (hxt)² is a collection of tools for parsing XML, aiming at a more general approach than the other tools.
- HaXml³ is a collection of utilities for parsing, filtering, transforming, and generating XML documents using Haskell.
- HXML⁴ is a non-validating, lazy, space efficient parser that can work as a drop-in replacement for HaXml.
- xml-conduit⁵ provides parsing and rendering functions for XML. For a tutorial see <http://www.yesodweb.com/book/xml>.

88.0.2 Libraries for generating XML

- HSXML represents XML documents as statically typesafe s-expressions.

88.0.3 Other options

- tagsoup⁶ is a library for parsing unstructured HTML, i.e. it does not assume validity or even well-formedness of the data.

88.1 Getting acquainted with HXT

In the following, we are going to use the Haskell XML Toolbox for our examples. You should have a working installation of GHC⁷, including GHCi, and you should have downloaded and installed HXT according to the instructions⁸.

1 Chapter 87 on page 615
2 <http://www.fh-wedel.de/~si/HXmlToolbox/>
3 <http://projects.haskell.org/HaXml/>
4 <http://www.flightlab.com/~joe/hxml/>
5 <https://hackage.haskell.org/package/xml-conduit>
6 <http://www.cs.york.ac.uk/fp/darcs/tagsoup/tagsoup.htm>
7 Chapter 2 on page 5
8 <http://www.fh-wedel.de/~si/HXmlToolbox/#install>

With those in place, we are ready to start playing with HXT. Let's bring the XML parser into scope, and parse a simple XML-formatted string:

```
Prelude> :m + Text.XML.HXT.Parser.XmlParsec
Prelude Text.XML.HXT.Parser.XmlParsec> xread "<foo>abc<bar/>def</foo>"
[NTree (XTag (QN {namePrefix = "", localPart = "foo", namespaceUri = ""}) [])]
[NTree (XText "abc") []],NTree (XTag (QN {namePrefix = "", localPart = "bar",
namespaceUri = ""}) []) [],NTree (XText "def") []]
```

We see that HXT represents an XML document as a list of trees, where the nodes can be constructed as an XTag containing a list of subtrees, or an XText containing a string. With GHCi, we can explore this in more detail:

```
Prelude> :m + Data.Tree.NTree.TypeDefs
Prelude Text.XML.HXT.Parser.XmlParsec Text.XML.HXT.DOM> :i NTree
data NTree a = NTree a (NTrees a)
-- Defined in Data.Tree.NTree.TypeDefs
Prelude Text.XML.HXT.Parser.XmlParsec Text.XML.HXT.DOM> :i NTrees
type NTrees a = [NTree a] -- Defined in Data.Tree.NTree.TypeDefs
```

As we can see, an NTree is a general tree structure where a node stores its children in a list, and some more browsing around will tell us that XML documents are trees over an XNode type, defined as:

```
data XNode
= XText String
| XCharRef Int
| XEntityRef String
| XCmt String
| XCdata String
| XPi QName XmlTrees
| XTag QName XmlTrees
| XDTD DTDElem Attributes
| XAttr QName
| XError Int String
```

Returning to our example, we notice that while HXT successfully parsed our input, one might desire a more lucid presentation for human consumption. Lucky for us, the DOM module supplies this. Notice that xread returns a list of trees, while the formatting function works on a single tree.

```
Prelude Text.XML.HXT.Parser.XmlParsec> :m + Text.XML.HXT.DOM.FormatXmlTree
Prelude Text.XML.HXT.Parser.XmlParsec Text.XML.HXT.DOM> putStrLn $ formatXmlTree $ head $ xread
"<foo>abc<bar/>def</foo>"
---XTag "foo"
|
+---XText "abc"
|
+---XTag "bar"
|
+---XText "def"
```

This representation makes the structure obvious, and it is easy to see the relationship to our input string. Let's proceed to extend our XML document with some attributes (taking care to escape the quotes, of course):

```
Prelude Text.XML.HXT.Parser.XmlParsec> xread "<foo a1=\"my\" b2=\"oh\">abc<bar/>def</foo>"
[NTree (XTag (QN {namePrefix = "", localPart = "foo", namespaceUri = ""}))
 [NTree (XAttr (QN {namePrefix = "", localPart = "a1", namespaceUri = ""})) [NTree (XText "my")
 []],NTree (XAttr
 (QN {namePrefix = "", localPart = "b2", namespaceUri = ""})) [NTree (XText
 "oh") []])] [NTree
 (XText "abc") [],NTree (XTag (QN {namePrefix = "", localPart = "bar",
 namespaceUri = ""})) []
 [],NTree (XText "def") []]
```

Notice that attributes are stored as regular NTree nodes with the XAttr content type, and (of course) no children. Feel free to pretty-print this expression, as we did above.

For a trivial example of data extraction, consider this small example using XPath⁹:

```
Prelude> :set prompt "> "
> :m + Text.XML.HXT.Parser.XmlParsec Text.XML.HXT.XPath.XPathEval
> let xml = "<foo>A<c>C</c></foo>"
> let xmltree = head $ xread xml
> let result = getXPath "//a" xmltree
> result
> [NTree (XTag (QN {namePrefix = "", localPart = "a", namespaceUri = ""})) []]
[NTree (XText "A") []]
> :t result
> result :: NTrees XNode
```

9 <http://en.wikipedia.org/wiki/XPath>

89 Using Regular Expressions

Good tutorials where to start

- [serpentine.com](http://www.serpentine.com)¹
- [Regular Expressions \(Haskell Wiki\)](http://www.haskell.org/haskellwiki/Regular_expressions)²

UNKNOWN TEMPLATE BOOKCATEGORY /Not in book³

¹ <http://www.serpentine.com/blog/2007/02/27/a-haskell-regular-expression-tutorial/>

² http://www.haskell.org/haskellwiki/Regular_expressions

³ <https://en.wikibooks.org/wiki/%2FNot%20in%20book>

90 Parsing Mathematical Expressions

This chapter discusses how to turn strings of text such as "3*sin x + y" into an abstract syntactic representation like `Plus (Times (Number 3) (Apply "sin" (Variable "x"))) (Variable "y")`.

We are going to use `Text.ParserCombinators.ReadP`¹ throughout, so you will need to have the reference open to refer to.

90.1 First Warmup

```
import Text.ParserCombinators.ReadP
```

For a warmup, to get started on the problem, we first try an easier problem. A language where the symbols are just the letter "o", a single operator "&" and brackets. First define a data type for these trees:

```
data Tree = Branch Tree Tree | Leaf deriving Show
```

Now a parser for leaves is defined using the `ReadP` library:

```
leaf = do char 'o'
         return Leaf
```

now to define a parser for the branches, made up by "&" operator we need to choose an associativity. That is, whether `o&o&o` should be the same as `(o&o)&o` or `o&(o&o)` - let us pick the latter.

For a first approximation we can forget about brackets, adding them in after the first "milestone":

```
branch = do a <- leaf
           char '&'
           b <- tree
           return (Branch a b)

tree = leaf +++ branch
```

¹ <http://hackage.haskell.org/packages/archive/base/latest/doc/html/Text-ParserCombinators-ReadP.html>

It's now possible to test this out and see if it acts properly on a few inputs:

```
*Main> readP_to_S tree "o"
[(Leaf,"")]
*Main> readP_to_S tree "o&o"
[(Leaf,"&o"),(Branch Leaf Leaf,"")]
*Main> readP_to_S tree "o&o&o"
[(Leaf,"&o&o"),(Branch Leaf Leaf,"&o"),(Branch Leaf (Branch Leaf Leaf),"")]
```

Since that worked fine we can proceed to add support for parenthesis. Brackets are defined generally, so that we can reuse it later on

```
brackets p = do char '('
               r <- p
               char ')'
               return r
```

We can now update the branch and tree parsers to support brackets:

```
branch = do a <- leaf +++ brackets tree
           char '&'
           b <- tree
           return (Branch a b)

tree = leaf +++ branch +++ brackets tree
```

A bit of testing shows that it seems to work

```
*Main> readP_to_S tree "((o&((o&o)))&o&((o&o)&o)&o)"
[(Branch (Branch Leaf (Branch Leaf Leaf)) (Branch Leaf (Branch (Branch
(Branch Leaf Leaf) Leaf) Leaf)),,"")]
```

90.2 Adaptation

This gives a good starting point for adaptation. The first modification towards the ultimate goal, which is quite easy to do, is changing the leaves from just "o" to any string. To do this we have change to 'Leaf' to 'Leaf String' in the data type and update the leaf function:

```
data Tree = Branch Tree Tree | Leaf String deriving Show

leaf = do s <- many1 (choice (map char ['a'..'z']))
       return (Leaf s)
```

For the next adaptation we try and add a new operation "|" which binds weaker than "&". I.e. "foo&bar|baz" should parse as "(foo&bar)|baz". First we need to update the data type representing syntax:

```

data Operator = And | Or deriving Show

data Tree = Branch Operator Tree Tree | Leaf String deriving Show

```

The obvious thing to do is duplicate the ‘branch’ function and call it ‘andBranch’ and ‘orBranch’, and give or precedence using the left choice operator ‘<+’:

```

andBranch = do a <- leaf +++ brackets tree
              char '&'
              b <- tree
              return (Branch And a b)

orBranch = do a <- leaf +++ brackets tree
              char '|'
              b <- tree
              return (Branch Or a b)

tree = leaf +++ (orBranch <+ andBranch) +++ brackets tree

```

This modification does not work though, if we think of an expression such as ”a&b&c&d|e&f&g&h|i&j&k|l&m&n&o|p&q&r|s” as a tree ”X|Y|Z|W|P|Q” (which we already know how to parse!) except that the leaves are a more complicated form (but again, one we already know how to parse) then we can compose a working parser:

```

andBranch = do a <- leaf +++ brackets tree
              char '&'
              b <- andTree
              return (Branch And a b)

andTree = leaf +++ brackets tree +++ andBranch

orBranch = do a <- andTree +++ brackets tree
              char '|'
              b <- orTree
              return (Branch Or a b)

orTree = andTree +++ brackets tree +++ orBranch

tree = orTree

```

While this approach does work, for example:

```

*Main> readP_to_S tree "(foo&bar|baz)"
[(Leaf "", "(foo&bar|baz)", (Branch Or (Branch And (Leaf "foo") (Leaf "bar")))
(Leaf "baz"), ""), (Branch Or (Branch And (Leaf "foo") (Leaf "bar"))) (Leaf
"baz"), "")]
*Main> readP_to_S tree "(foo|bar&baz)"
[(Leaf "", "(foo|bar&baz)", (Branch Or (Leaf "foo") (Branch And (Leaf "bar")
(Leaf "baz"))), ""), (Branch Or (Leaf "foo") (Branch And (Leaf "bar") (Leaf
"baz"))), "")]

```

it parses ambiguously, which is undesirable for efficiency reasons as well as hinting that we may have done something unnatural. Both ‘andTree’ and ‘orTree’ functions have ‘brackets tree’ in them, since ‘orTree’ contains ‘andTree’ this is where the ambiguity creeps in. To

solve it we simply delete from 'orTree'.

```
orTree = andTree +++ orBranch
```

90.3 Structure Emerges

All the previous fiddling and playing has actually caused a significant portion of the structure of our final program to make its-self clear. Looking back at what was written we could quite easily extend it to add another operator, and another after that (Exercise for the reader: if it is not clear exactly how this would be done, figure it out and do it). A moments meditation suggests that we might complete this pattern and abstract it out, given an arbitrarily long list of operators

```
operators = [(Or,"|"),(And,"+")]
```

or perhaps

```
data Operator = Add | Mul | Exp deriving Show
operators = [(Add,"+"),(Mul,"*"),(Exp,"^")]
```

the parser should be computed from it, nesting it (as we did manually in the past) so that parses happen correctly without ambiguity.

The seasoned haskell programmer will have already seen, in her minds eye, the following:

```
tree = foldr \(op,name) p ->
    let this = p +++ do a <- p +++ brackets tree
        char name
        b <- this
        return (Branch op a b)
    in this)
(leaf +++ brackets tree)
operators
```

which is then tested.

```
*Main> readP_to_S tree "(x^e*y+w^e*z^e)"
[(Leaf "", "(x^e*y+w^e*z^e)", (Branch Add (Branch Mul (Branch Exp (Leaf "x") (Leaf "e"))) (Leaf "y"))) (Branch Mul (Branch Exp (Leaf "w") (Leaf "e"))) (Branch Exp (Leaf "z") (Leaf "e"))), ""]]
```

This is a good checkpoint to pause, in summary we have distilled the embryonic parser down to the following script:

```

import Text.ParserCombinators.ReadP

brackets p = do char '('
                r <- p
                char ')'
                return r

data Operator = Add | Mul | Exp deriving Show
operators = [(Add, '+'), (Mul, '*'), (Exp, '^')]

data Tree = Branch Operator Tree Tree | Leaf String deriving Show

leaf = do s <- many1 (choice (map char ['a'..'z']))
        return (Leaf s)

tree = foldr (\(op,name) p ->
             let this = p +++ do a <- p +++ brackets tree
                                 char name
                                 b <- this
                                 return (Branch op a b)
             in this)
        (leaf +++ brackets tree)
        operators
    
```

90.4 Whitespace and applicative notation

Since both the functional/applicative notation and ignoring whitespace depend on some of the same characters (space characters) it is a useful question to ask which should be implemented first, or whether it is not important which should be programmed first.

Considering the expression "f x", suggests that we should find how to parse whitespace before handling applicative notation, since once it has been dealt with function application should just correspond to simple juxtaposition (as intended).

There is a technical difficulty making our current parser ignore whitespace: if we were to make a 'skipWhitespace' parser, and put it everywhere that whitespace could occur we would be inundated with ambiguous parses. Hence it is necessary to skip whitespace only in certain crucial places, for example we could pick the convention that whitespace is always skipped *before* reading a token. Then "a + b * c" would be seen by the parser chunked in the following way "[a][+][b][*][c][]". Which convention we choose is arbitrary, but ignoring whitespace before seems slightly neater, since it handles "a" without any complaints.

We define the following:

```

skipWhitespace = do many (choice (map char [' ', '\n']))
                 return ()
    
```

and update all the parses written before, so that they follow the new convention

```

brackets p = do skipWhitespace
                char '('
                r <- p
                skipWhitespace
    
```

```

        char ')'
        return r

leaf = do skipWhitespace
        s <- many1 (choice (map char ['a'..'z']))
        return (Leaf s)

tree = foldr (\(op,name) p ->
            let this = p +++ do a <- p +++ brackets tree
                                skipWhitespace
                                char name
                                b <- this
                                return (Branch op a b)
                in this)
        (leaf +++ brackets tree)
        operators

```

In order to add applicative support clearly the syntax needs to allow for it:

```

data Tree = Apply Tree Tree | Branch Operator Tree Tree | Leaf String
deriving Show

```

This syntax tree will allow for sentences such as $(x + y)$ foo”, while this not correct other sentences like $(f . g) x$ ” are commonplace in haskell - it should be the job of the type-checker to decide which is meaningful and which is not: This separation of concerns lets our problem (parsing) remain simple and homogeneous.

Our parser is essentially just two functions ‘leaf’ and ‘tree’ (‘skipWhitespace’ and ‘brackets’ being considered ”library” or helper functions). The function ‘tree’ eats up all the operators it can, attaching leaves onto them as it can. While the ‘leaf’ function could be thought of as reading in anything which doesn't have operators in it. Given this view of the program it is clear that to support applicative notation one needs to replace leaf with something that parses a chain of functional applications.

The obvious thing to try is then,

```

leaf = chainl1 (do skipWhitespace
                 s <- many1 (choice (map char ['a'..'z']))
                 return (Leaf s))
              (return Apply)

```

and it is easily extended to support the ”commonplace” compound sentences discussed earlier:

```

leaf = chainl1 (brackets tree
               +++ do skipWhitespace
                     s <- many1 (choice (map char ['a'..'z']))
                     return (Leaf s))
              (return Apply)

```

This is the problem completely solved! Our original goal is completed, one only needs to specify the operators they would like to have (in order) and write a traversal function

converts the ‘Tree’ into say mathematical expressions -- giving errors if unknown functions were used etc.

90.4.1 Making it Modular

The algorithms written are general enough to be useful in different circumstances, and even if they only had a single use -- if we were planning on using them in a larger program it is essential that we isolate the internals from the externals (its interface).

```

module Parser
  ( Tree(..), parseExpression
  ) where

import Data.Maybe
import Text.ParserCombinators.ReadP

skipWhitespace = do many (choice (map char [' ', '\n']))
                  return ()

brackets p = do skipWhitespace
                char '('
                r <- p
                skipWhitespace
                char ')'
                return r

data Tree op = Apply (Tree op) (Tree op) | Branch op (Tree op) (Tree op) | Leaf
String deriving Show

parseExpression operators = listToMaybe . map fst . filter (null .snd) .
readP_to_S tree where
  leaf = chainl1 (brackets tree
                +++ do skipWhitespace
                       s <- many1 (choice (map char ['a'..'z']))
                       return (Leaf s))
        (return Apply)
  tree = foldr (\(op,name) p ->
                let this = p +++ do a <- p +++ brackets tree
                                    skipWhitespace
                                    char name
                                    b <- this
                                    return (Branch op a b)
                in this)
        (leaf +++ brackets tree)
        operators

```

91 Contributors

Edits	User
1	Aaarbk ¹
1	Aaronsteers~enwikibooks ²
1	Abdelazer ³
6	Acangiano ⁴
1	AdRiley ⁵
1	Adrianneumann ⁶
11	Adrignola ⁷
1	Aeinner ⁸
1	Ahersen ⁹
3	Albmont ¹⁰
3	Alexanderaltman ¹¹
1	Alexandre.delanoe ¹²
5	Alexey Feldgendler ¹³
31	Alexey Muranov ¹⁴
1	Alexvy86 ¹⁵
8	AllenZh ¹⁶
2	Almkglor~enwikibooks ¹⁷
20	Amire80 ¹⁸
1	Ammon ¹⁹

1 <https://en.wikibooks.org/w/index.php%3ftitle=User:Aaarbk&action=edit&redlink=1>
2 <https://en.wikibooks.org/w/index.php%3ftitle=User:Aaronsteers~enwikibooks&action=edit&redlink=1>
3 <https://en.wikibooks.org/wiki/User:Abdelazer>
4 <https://en.wikibooks.org/wiki/User:Acangiano>
5 <https://en.wikibooks.org/wiki/User:AdRiley>
6 <https://en.wikibooks.org/w/index.php%3ftitle=User:Adrianneumann&action=edit&redlink=1>
7 <https://en.wikibooks.org/wiki/User:Adrignola>
8 <https://en.wikibooks.org/w/index.php%3ftitle=User:Aeinner&action=edit&redlink=1>
9 <https://en.wikibooks.org/w/index.php%3ftitle=User:Ahersen&action=edit&redlink=1>
10 <https://en.wikibooks.org/wiki/User:Albmont>
11 <https://en.wikibooks.org/w/index.php%3ftitle=User:Alexanderaltman&action=edit&redlink=1>
12 <https://en.wikibooks.org/w/index.php%3ftitle=User:Alexandre.delanoe&action=edit&redlink=1>
13 https://en.wikibooks.org/wiki/User:Alexey_Feldgendler
14 https://en.wikibooks.org/w/index.php%3ftitle=User:Alexey_Muranov&action=edit&redlink=1
15 <https://en.wikibooks.org/w/index.php%3ftitle=User:Alexvy86&action=edit&redlink=1>
16 <https://en.wikibooks.org/wiki/User:AllenZh>
17 <https://en.wikibooks.org/w/index.php%3ftitle=User:Almkglor~enwikibooks&action=edit&redlink=1>
18 <https://en.wikibooks.org/wiki/User:Amire80>
19 <https://en.wikibooks.org/w/index.php%3ftitle=User:Ammon&action=edit&redlink=1>

3 Anareth²⁰
1 Ancheta Wis²¹
1 Anders Kaseorg²²
1 Andreaskern²³
6 Andrebolle²⁴
3 Android B780²⁵
1 Aniloadam²⁶
1 Antoine9298²⁷
4 Anton Lorenzen²⁸
1 Apalamarchuk²⁹
195 Apfelmus³⁰
1 Asknell³¹
1 Astroman3D³²
4 Atcovi³³
1 Atkachu³⁴
1 AugPi³⁵
1 Augustss~enwikibooks³⁶
1 Avalez³⁷
22 Avicennasis³⁸
1 Avijja~enwikibooks³⁹
1 Axa⁴⁰
6 Axnicho⁴¹
1 Ayathustra⁴²
1 B7j0c⁴³

20 <https://en.wikibooks.org/w/index.php%3ftitle=User:Anareth&action=edit&redlink=1>
21 https://en.wikibooks.org/w/index.php%3ftitle=User:Ancheta_Wis&action=edit&redlink=1
22 https://en.wikibooks.org/w/index.php%3ftitle=User:Anders_Kaseorg&action=edit&redlink=1
23 <https://en.wikibooks.org/w/index.php%3ftitle=User:Andreaskern&action=edit&redlink=1>
24 <https://en.wikibooks.org/w/index.php%3ftitle=User:Andrebolle&action=edit&redlink=1>
25 https://en.wikibooks.org/w/index.php%3ftitle=User:Android_B780&action=edit&redlink=1
26 <https://en.wikibooks.org/w/index.php%3ftitle=User:Aniloadam&action=edit&redlink=1>
27 <https://en.wikibooks.org/w/index.php%3ftitle=User:Antoine9298&action=edit&redlink=1>
28 https://en.wikibooks.org/w/index.php%3ftitle=User:Anton_Lorenzen&action=edit&redlink=1
29 <https://en.wikibooks.org/w/index.php%3ftitle=User:Apalamarchuk&action=edit&redlink=1>
30 <https://en.wikibooks.org/wiki/User:Apfelmus>
31 <https://en.wikibooks.org/w/index.php%3ftitle=User:Asknell&action=edit&redlink=1>
32 <https://en.wikibooks.org/w/index.php%3ftitle=User:Astroman3D&action=edit&redlink=1>
33 <https://en.wikibooks.org/wiki/User:Atcovi>
34 <https://en.wikibooks.org/w/index.php%3ftitle=User:Atkachu&action=edit&redlink=1>
35 <https://en.wikibooks.org/wiki/User:AugPi>
36 <https://en.wikibooks.org/w/index.php%3ftitle=User:Augustss~enwikibooks&action=edit&redlink=1>
37 <https://en.wikibooks.org/w/index.php%3ftitle=User:Avalez&action=edit&redlink=1>
38 <https://en.wikibooks.org/wiki/User:Avicennasis>
39 <https://en.wikibooks.org/w/index.php%3ftitle=User:Avijja~enwikibooks&action=edit&redlink=1>
40 <https://en.wikibooks.org/w/index.php%3ftitle=User:Axa&action=edit&redlink=1>
41 <https://en.wikibooks.org/w/index.php%3ftitle=User:Axnicho&action=edit&redlink=1>
42 <https://en.wikibooks.org/w/index.php%3ftitle=User:Ayathustra&action=edit&redlink=1>
43 <https://en.wikibooks.org/w/index.php%3ftitle=User:B7j0c&action=edit&redlink=1>

10	BCW ⁴⁴
157	Backfromquadrangle ⁴⁵
2	Bart Massey~enwikibooks ⁴⁶
5	Bartosz ⁴⁷
1	Basvandijk ⁴⁸
6	Ben Standeven ⁴⁹
2	Bhathaway ⁵⁰
14	BiT ⁵¹
1	Billinghurst ⁵²
1	Billymac00 ⁵³
1	BlackMeph ⁵⁴
39	Blackh ⁵⁵
17	Blaisorblade ⁵⁶
4	Bli ⁵⁷
2	Blogscot ⁵⁸
1	Blue Penguin Toad Frog ⁵⁹
1	Bos~enwikibooks ⁶⁰
1	Brandizzi ⁶¹
1	Brateevsky ⁶²
3	Brennon~enwikibooks ⁶³
8	Bsddaemon ⁶⁴
1	Bstpierre ⁶⁵
1	Bulldog98 ⁶⁶
14	Byorgey ⁶⁷

44	https://en.wikibooks.org/wiki/User:BCW
45	https://en.wikibooks.org/w/index.php%3ftitle=User:Backfromquadrangle&action=edit&redlink=1
46	https://en.wikibooks.org/w/index.php%3ftitle=User:Bart_Massey~enwikibooks&action=edit&redlink=1
47	https://en.wikibooks.org/wiki/User:Bartosz
48	https://en.wikibooks.org/w/index.php%3ftitle=User:Basvandijk&action=edit&redlink=1
49	https://en.wikibooks.org/w/index.php%3ftitle=User:Ben_Standeven&action=edit&redlink=1
50	https://en.wikibooks.org/w/index.php%3ftitle=User:Bhathaway&action=edit&redlink=1
51	https://en.wikibooks.org/wiki/User:BiT
52	https://en.wikibooks.org/wiki/User:Billinghurst
53	https://en.wikibooks.org/w/index.php%3ftitle=User:Billymac00&action=edit&redlink=1
54	https://en.wikibooks.org/w/index.php%3ftitle=User:BlackMeph&action=edit&redlink=1
55	https://en.wikibooks.org/w/index.php%3ftitle=User:Blackh&action=edit&redlink=1
56	https://en.wikibooks.org/w/index.php%3ftitle=User:Blaisorblade&action=edit&redlink=1
57	https://en.wikibooks.org/w/index.php%3ftitle=User:Bli&action=edit&redlink=1
58	https://en.wikibooks.org/wiki/User:Blogscot
59	https://en.wikibooks.org/w/index.php%3ftitle=User:Blue_Penguin_Toad_Frog&action=edit&redlink=1
60	https://en.wikibooks.org/w/index.php%3ftitle=User:Bos~enwikibooks&action=edit&redlink=1
61	https://en.wikibooks.org/w/index.php%3ftitle=User:Brandizzi&action=edit&redlink=1
62	https://en.wikibooks.org/wiki/User:Brateevsky
63	https://en.wikibooks.org/w/index.php%3ftitle=User:Brennon~enwikibooks&action=edit&redlink=1
64	https://en.wikibooks.org/w/index.php%3ftitle=User:Bsddaemon&action=edit&redlink=1
65	https://en.wikibooks.org/w/index.php%3ftitle=User:Bstpierre&action=edit&redlink=1
66	https://en.wikibooks.org/wiki/User:Bulldog98
67	https://en.wikibooks.org/wiki/User:Byorgey

3	CD-Host ⁶⁸
2	Calvins ⁶⁹
8	Canadaduane ⁷⁰
11	Catamorphism ⁷¹
1	Catofax~enwikibooks ⁷²
1	Cdgarrett1966 ⁷³
1	Cdunn2001~enwikibooks ⁷⁴
5	Cheshire~enwikibooks ⁷⁵
9	Chief sequoya ⁷⁶
1	Chris Forno ⁷⁷
1	ChrisKuklewicz ⁷⁸
1	Chrissounds ⁷⁹
2	Christofian ⁸⁰
33	Cic ⁸¹
4	Clj~enwikibooks ⁸²
2	Codeispoetry ⁸³
1	CommonsDelinker ⁸⁴
1	Cptrodolfox ⁸⁵
13	Crasshopper ⁸⁶
1	Ctnd ⁸⁷
1	Damien Cassou ⁸⁸
6	Dandel-rovbur ⁸⁹
3	Daniel5Ko ⁹⁰
1	DanielSchoepe ⁹¹

68	https://en.wikibooks.org/w/index.php%3ftitle=User:CD-Host&action=edit&redlink=1
69	https://en.wikibooks.org/w/index.php%3ftitle=User:Calvins&action=edit&redlink=1
70	https://en.wikibooks.org/w/index.php%3ftitle=User:Canadaduane&action=edit&redlink=1
71	https://en.wikibooks.org/wiki/User:Catamorphism
72	https://en.wikibooks.org/w/index.php%3ftitle=User:Catofax~enwikibooks&action=edit&redlink=1
73	https://en.wikibooks.org/w/index.php%3ftitle=User:Cdgarrett1966&action=edit&redlink=1
74	https://en.wikibooks.org/w/index.php%3ftitle=User:Cdunn2001~enwikibooks&action=edit&redlink=1
75	https://en.wikibooks.org/w/index.php%3ftitle=User:Cheshire~enwikibooks&action=edit&redlink=1
76	https://en.wikibooks.org/w/index.php%3ftitle=User:Chief_sequoya&action=edit&redlink=1
77	https://en.wikibooks.org/w/index.php%3ftitle=User:Chris_Forno&action=edit&redlink=1
78	https://en.wikibooks.org/w/index.php%3ftitle=User:ChrisKuklewicz&action=edit&redlink=1
79	https://en.wikibooks.org/w/index.php%3ftitle=User:Chrissounds&action=edit&redlink=1
80	https://en.wikibooks.org/w/index.php%3ftitle=User:Christofian&action=edit&redlink=1
81	https://en.wikibooks.org/w/index.php%3ftitle=User:Cic&action=edit&redlink=1
82	https://en.wikibooks.org/w/index.php%3ftitle=User:Clj~enwikibooks&action=edit&redlink=1
83	https://en.wikibooks.org/wiki/User:Codeispoetry
84	https://en.wikibooks.org/wiki/User:CommonsDelinker
85	https://en.wikibooks.org/w/index.php%3ftitle=User:Cptrodolfox&action=edit&redlink=1
86	https://en.wikibooks.org/wiki/User:Crasshopper
87	https://en.wikibooks.org/w/index.php%3ftitle=User:Ctnd&action=edit&redlink=1
88	https://en.wikibooks.org/w/index.php%3ftitle=User:Damien_Cassou&action=edit&redlink=1
89	https://en.wikibooks.org/w/index.php%3ftitle=User:Dandel-rovbur&action=edit&redlink=1
90	https://en.wikibooks.org/w/index.php%3ftitle=User:Daniel5Ko&action=edit&redlink=1
91	https://en.wikibooks.org/w/index.php%3ftitle=User:DanielSchoepe&action=edit&redlink=1

- 254 DavidHouse⁹²
- 1 Davorak⁹³
- 1 Deacon Vorbis⁹⁴
- 1 Denny⁹⁵
- 2 Derekmahar⁹⁶
- 1 Dherington⁹⁷
- 4 Diddymus⁹⁸
- 58 Digichoron⁹⁹
- 1 DimoneSem¹⁰⁰
- 1 Dino~enwikibooks¹⁰¹
- 22 Dirk Hünninger¹⁰²
- 3 Dporter¹⁰³
- 1 Dukedave~enwikibooks¹⁰⁴
- 1239 Duplode¹⁰⁵
- 1 Długosz¹⁰⁶
- 2 EddieTwo¹⁰⁷
- 3 Edward Z. Yang¹⁰⁸
- 1 Eihjia~enwikibooks¹⁰⁹
- 1 EricCHill¹¹⁰
- 3 Erich~enwikibooks¹¹¹
- 2 ErikFK¹¹²
- 2 EvanCarroll¹¹³
- 1 Farzad ghanei¹¹⁴
- 1 Favonia¹¹⁵

-
- 92 <https://en.wikibooks.org/wiki/User:DavidHouse>
 - 93 <https://en.wikibooks.org/w/index.php%3ftitle=User:Davorak&action=edit&redlink=1>
 - 94 https://en.wikibooks.org/w/index.php%3ftitle=User:Deacon_Vorbis&action=edit&redlink=1
 - 95 <https://en.wikibooks.org/wiki/User:Denny>
 - 96 <https://en.wikibooks.org/w/index.php%3ftitle=User:Derekmahar&action=edit&redlink=1>
 - 97 <https://en.wikibooks.org/w/index.php%3ftitle=User:Dherington&action=edit&redlink=1>
 - 98 <https://en.wikibooks.org/w/index.php%3ftitle=User:Diddymus&action=edit&redlink=1>
 - 99 <https://en.wikibooks.org/wiki/User:Digichoron>
 - 100 <https://en.wikibooks.org/w/index.php%3ftitle=User:DimoneSem&action=edit&redlink=1>
 - 101 <https://en.wikibooks.org/w/index.php%3ftitle=User:Dino~enwikibooks&action=edit&redlink=1>
 - 102 https://en.wikibooks.org/wiki/User:Dirk_H%25C3%25BCnniger
 - 103 <https://en.wikibooks.org/w/index.php%3ftitle=User:Dporter&action=edit&redlink=1>
 - 104 <https://en.wikibooks.org/w/index.php%3ftitle=User:Dukedave~enwikibooks&action=edit&redlink=1>
 - 105 <https://en.wikibooks.org/wiki/User:Duplode>
 - 106 <https://en.wikibooks.org/w/index.php%3ftitle=User:D%25C5%2582ugosz&action=edit&redlink=1>
 - 107 <https://en.wikibooks.org/w/index.php%3ftitle=User:EddieTwo&action=edit&redlink=1>
 - 108 https://en.wikibooks.org/wiki/User:Edward_Z._Yang
 - 109 <https://en.wikibooks.org/w/index.php%3ftitle=User:Eihjia~enwikibooks&action=edit&redlink=1>
 - 110 <https://en.wikibooks.org/wiki/User:EricCHill>
 - 111 <https://en.wikibooks.org/w/index.php%3ftitle=User:Erich~enwikibooks&action=edit&redlink=1>
 - 112 <https://en.wikibooks.org/w/index.php%3ftitle=User:ErikFK&action=edit&redlink=1>
 - 113 <https://en.wikibooks.org/wiki/User:EvanCarroll>
 - 114 https://en.wikibooks.org/wiki/User:Farzad_ghanei
 - 115 <https://en.wikibooks.org/w/index.php%3ftitle=User:Favonia&action=edit&redlink=1>

2 Felix C. Stegerman¹¹⁶
6 Fieryhydra¹¹⁷
1 Fishpi¹¹⁸
1 Fjf2002¹¹⁹
1 Fluxion~enwikibooks¹²⁰
1 Freinn¹²¹
2 Froth¹²²
1 Fshahriar¹²³
13 GPhilip¹²⁴
4 GRiba2010¹²⁵
3 Gauthier~enwikibooks¹²⁶
1 Gdweber~enwikibooks¹²⁷
3 GeordieMcBain¹²⁸
2 Gert~enwikibooks¹²⁹
1 Gerymate¹³⁰
1 Ghostzart¹³¹
2 Gh~enwikibooks¹³²
1 Glaisher¹³³
1 Glosser.ca¹³⁴
5 Gmachine¹³⁵
1 Goheeca¹³⁶
1 Googl¹³⁷
2 GorgeUbuasha¹³⁸
1 Gotoki no joe¹³⁹

116 https://en.wikibooks.org/w/index.php?ftitle=User:Felix_C._Stegerman&action=edit&redlink=1
117 <https://en.wikibooks.org/w/index.php?ftitle=User:Fieryhydra&action=edit&redlink=1>
118 <https://en.wikibooks.org/w/index.php?ftitle=User:Fishpi&action=edit&redlink=1>
119 <https://en.wikibooks.org/w/index.php?ftitle=User:Fjf2002&action=edit&redlink=1>
120 <https://en.wikibooks.org/w/index.php?ftitle=User:Fluxion~enwikibooks&action=edit&redlink=1>
121 <https://en.wikibooks.org/w/index.php?ftitle=User:Freinn&action=edit&redlink=1>
122 <https://en.wikibooks.org/w/index.php?ftitle=User:Froth&action=edit&redlink=1>
123 <https://en.wikibooks.org/w/index.php?ftitle=User:Fshahriar&action=edit&redlink=1>
124 <https://en.wikibooks.org/w/index.php?ftitle=User:GPhilip&action=edit&redlink=1>
125 <https://en.wikibooks.org/w/index.php?ftitle=User:GRiba2010&action=edit&redlink=1>
126 <https://en.wikibooks.org/w/index.php?ftitle=User:Gauthier~enwikibooks&action=edit&redlink=1>
127 <https://en.wikibooks.org/w/index.php?ftitle=User:Gdweber~enwikibooks&action=edit&redlink=1>
128 <https://en.wikibooks.org/w/index.php?ftitle=User:GeordieMcBain&action=edit&redlink=1>
129 <https://en.wikibooks.org/w/index.php?ftitle=User:Gert~enwikibooks&action=edit&redlink=1>
130 <https://en.wikibooks.org/w/index.php?ftitle=User:Gerymate&action=edit&redlink=1>
131 <https://en.wikibooks.org/w/index.php?ftitle=User:Ghostzart&action=edit&redlink=1>
132 <https://en.wikibooks.org/w/index.php?ftitle=User:Gh~enwikibooks&action=edit&redlink=1>
133 <https://en.wikibooks.org/wiki/User:Glaisher>
134 <https://en.wikibooks.org/w/index.php?ftitle=User:Glosser.ca&action=edit&redlink=1>
135 <https://en.wikibooks.org/w/index.php?ftitle=User:Gmachine&action=edit&redlink=1>
136 <https://en.wikibooks.org/w/index.php?ftitle=User:Goheeca&action=edit&redlink=1>
137 <https://en.wikibooks.org/w/index.php?ftitle=User:Googl&action=edit&redlink=1>
138 <https://en.wikibooks.org/wiki/User:GorgeUbuasha>
139 https://en.wikibooks.org/w/index.php?ftitle=User:Gotoki_no_joe&action=edit&redlink=1

- 1 Gphilip¹⁴⁰
- 1 Gracenotes¹⁴¹
- 2 GreatBigDot¹⁴²
- 2 Greenrd¹⁴³
- 3 GreggHB¹⁴⁴
- 1 Gregorias¹⁴⁵
- 1 Guoguo12¹⁴⁶
- 51 Gwern¹⁴⁷
- 5 Gwideman¹⁴⁸
- 1 Götz¹⁴⁹
- 2 Hairy Dude¹⁵⁰
- 1 Hajhouse¹⁵¹
- 4 Hansix¹⁵²
- 17 Hathal¹⁵³
- 3 Henrylaxen¹⁵⁴
- 1 Herbythyme¹⁵⁵
- 1 HethrirBot¹⁵⁶
- 4 Hkhooda¹⁵⁷
- 1 HostileFork¹⁵⁸
- 3 How Si Yu¹⁵⁹
- 3 HowardBGolden¹⁶⁰
- 1 Huwpuwynyty¹⁶¹
- 1 Igorrafaeldesousa¹⁶²
- 12 Ihope127¹⁶³
- 4 Immanuel.normann¹⁶⁴

140 <https://en.wikibooks.org/w/index.php%3ftitle=User:Gphilip&action=edit&redlink=1>

141 <https://en.wikibooks.org/wiki/User:Gracenotes>

142 <https://en.wikibooks.org/w/index.php%3ftitle=User:GreatBigDot&action=edit&redlink=1>

143 <https://en.wikibooks.org/wiki/User:Greenrd>

144 <https://en.wikibooks.org/w/index.php%3ftitle=User:GreggHB&action=edit&redlink=1>

145 <https://en.wikibooks.org/w/index.php%3ftitle=User:Gregorias&action=edit&redlink=1>

146 <https://en.wikibooks.org/wiki/User:Guoguo12>

147 <https://en.wikibooks.org/wiki/User:Gwern>

148 <https://en.wikibooks.org/w/index.php%3ftitle=User:Gwideman&action=edit&redlink=1>

149 <https://en.wikibooks.org/w/index.php%3ftitle=User:G%25C3%25B6tz&action=edit&redlink=1>

150 https://en.wikibooks.org/wiki/User:Hairy_Dude

151 <https://en.wikibooks.org/w/index.php%3ftitle=User:Hajhouse&action=edit&redlink=1>

152 <https://en.wikibooks.org/w/index.php%3ftitle=User:Hansix&action=edit&redlink=1>

153 <https://en.wikibooks.org/w/index.php%3ftitle=User:Hathal&action=edit&redlink=1>

154 <https://en.wikibooks.org/w/index.php%3ftitle=User:Henrylaxen&action=edit&redlink=1>

155 <https://en.wikibooks.org/wiki/User:Herbythyme>

156 <https://en.wikibooks.org/wiki/User:HethrirBot>

157 <https://en.wikibooks.org/w/index.php%3ftitle=User:Hkhooda&action=edit&redlink=1>

158 <https://en.wikibooks.org/w/index.php%3ftitle=User:HostileFork&action=edit&redlink=1>

159 https://en.wikibooks.org/w/index.php%3ftitle=User:How_Si_Yu&action=edit&redlink=1

160 <https://en.wikibooks.org/wiki/User:HowardBGolden>

161 <https://en.wikibooks.org/w/index.php%3ftitle=User:Huwpuwynyty&action=edit&redlink=1>

162 <https://en.wikibooks.org/w/index.php%3ftitle=User:Igorrafaeldesousa&action=edit&redlink=1>

163 <https://en.wikibooks.org/wiki/User:Ihope127>

164 <https://en.wikibooks.org/w/index.php%3ftitle=User:Immanuel.normann&action=edit&redlink=1>

3 Indil~enwikibooks¹⁶⁵
1 Insanity¹⁶⁶
2 Ithika~enwikibooks¹⁶⁷
1 IvarTJ¹⁶⁸
3 JackBot¹⁶⁹
1 JackPotte¹⁷⁰
2 Jagraham¹⁷¹
1 James.h.saunders¹⁷²
1 Jamesfisher¹⁷³
1 Jarould¹⁷⁴
1 Jas~enwikibooks¹⁷⁵
2 Jbalint~enwikibooks¹⁷⁶
1 Jbolden1517¹⁷⁷
4 Jdgilbey¹⁷⁸
6 Jeffwheeler¹⁷⁹
2 Jfeltz¹⁸⁰
37 Jguk¹⁸¹
1 Jhenligne¹⁸²
3 Jjinux¹⁸³
3 Jleedev¹⁸⁴
4 Joee92~enwikibooks¹⁸⁵
1 Joeyadams¹⁸⁶
1 JohnBeattie¹⁸⁷
2 Jsholland¹⁸⁸

165 <https://en.wikibooks.org/w/index.php%3ftitle=User:Indil~enwikibooks&action=edit&redlink=1>
166 <https://en.wikibooks.org/w/index.php%3ftitle=User:Insanity&action=edit&redlink=1>
167 <https://en.wikibooks.org/w/index.php%3ftitle=User:Ithika~enwikibooks&action=edit&redlink=1>
168 <https://en.wikibooks.org/w/index.php%3ftitle=User:IvarTJ&action=edit&redlink=1>
169 <https://en.wikibooks.org/wiki/User:JackBot>
170 <https://en.wikibooks.org/wiki/User:JackPotte>
171 <https://en.wikibooks.org/w/index.php%3ftitle=User:Jagraham&action=edit&redlink=1>
172 <https://en.wikibooks.org/w/index.php%3ftitle=User:James.h.saunders&action=edit&redlink=1>
173 <https://en.wikibooks.org/w/index.php%3ftitle=User:Jamesfisher&action=edit&redlink=1>
174 <https://en.wikibooks.org/wiki/User:Jarould>
175 <https://en.wikibooks.org/w/index.php%3ftitle=User:Jas~enwikibooks&action=edit&redlink=1>
176 <https://en.wikibooks.org/w/index.php%3ftitle=User:Jbalint~enwikibooks&action=edit&redlink=1>
177 <https://en.wikibooks.org/w/index.php%3ftitle=User:Jbolden1517&action=edit&redlink=1>
178 <https://en.wikibooks.org/wiki/User:Jdgilbey>
179 <https://en.wikibooks.org/w/index.php%3ftitle=User:Jeffwheeler&action=edit&redlink=1>
180 <https://en.wikibooks.org/w/index.php%3ftitle=User:Jfeltz&action=edit&redlink=1>
181 <https://en.wikibooks.org/wiki/User:Jguk>
182 <https://en.wikibooks.org/w/index.php%3ftitle=User:Jhenligne&action=edit&redlink=1>
183 <https://en.wikibooks.org/w/index.php%3ftitle=User:Jjinux&action=edit&redlink=1>
184 <https://en.wikibooks.org/w/index.php%3ftitle=User:Jleedev&action=edit&redlink=1>
185 <https://en.wikibooks.org/w/index.php%3ftitle=User:Joee92~enwikibooks&action=edit&redlink=1>
186 <https://en.wikibooks.org/w/index.php%3ftitle=User:Joeyadams&action=edit&redlink=1>
187 <https://en.wikibooks.org/w/index.php%3ftitle=User:JohnBeattie&action=edit&redlink=1>
188 <https://en.wikibooks.org/w/index.php%3ftitle=User:Jsholland&action=edit&redlink=1>

15	Jsnx ¹⁸⁹
1	Kbakalar ¹⁹⁰
3	Ketil ¹⁹¹
1	Kiefek ¹⁹²
1	Knuton ¹⁹³
903	Kowey ¹⁹⁴
8	Laura huber ¹⁹⁵
2	Leaderboard ¹⁹⁶
1	Leftaroundabout ¹⁹⁷
1	Lheinman ¹⁹⁸
1	Linopolus ¹⁹⁹
1	LokiClock ²⁰⁰
5	Lord-Raizen ²⁰¹
7	LungZeno~enwikibooks ²⁰²
10	Lusum ²⁰³
1	Lynnarddai ²⁰⁴
4	Lysxia ²⁰⁵
1	MMF ²⁰⁶
1	MarSch ²⁰⁷
4	Marc van Leeuwen ²⁰⁸
3	Marky1991~enwikibooks ²⁰⁹
17	Marudubshinki ²¹⁰
1	Mathnerd314159 ²¹¹
1	Mattcox ²¹²

189 <https://en.wikibooks.org/w/index.php%3ftitle=User:Jsnx&action=edit&redlink=1>
190 <https://en.wikibooks.org/w/index.php%3ftitle=User:Kbakalar&action=edit&redlink=1>
191 <https://en.wikibooks.org/wiki/User:Ketil>
192 <https://en.wikibooks.org/w/index.php%3ftitle=User:Kie%25C5%2582ek&action=edit&redlink=1>
193 <https://en.wikibooks.org/w/index.php%3ftitle=User:Knuton&action=edit&redlink=1>
194 <https://en.wikibooks.org/wiki/User:Kowey>
195 https://en.wikibooks.org/w/index.php%3ftitle=User:Laura_huber&action=edit&redlink=1
196 <https://en.wikibooks.org/wiki/User:Leaderboard>
197 <https://en.wikibooks.org/w/index.php%3ftitle=User:Leftaroundabout&action=edit&redlink=1>
198 <https://en.wikibooks.org/w/index.php%3ftitle=User:Lheinman&action=edit&redlink=1>
199 <https://en.wikibooks.org/w/index.php%3ftitle=User:Linopolus&action=edit&redlink=1>
200 <https://en.wikibooks.org/wiki/User:LokiClock>
201 <https://en.wikibooks.org/w/index.php%3ftitle=User:Lord-Raizen&action=edit&redlink=1>
202 <https://en.wikibooks.org/w/index.php%3ftitle=User:LungZeno~enwikibooks&action=edit&redlink=1>
203 <https://en.wikibooks.org/wiki/User:Lusum>
204 <https://en.wikibooks.org/w/index.php%3ftitle=User:Lynnarddai&action=edit&redlink=1>
205 <https://en.wikibooks.org/w/index.php%3ftitle=User:Lysxia&action=edit&redlink=1>
206 <https://en.wikibooks.org/w/index.php%3ftitle=User:MMF&action=edit&redlink=1>
207 <https://en.wikibooks.org/wiki/User:MarSch>
208 https://en.wikibooks.org/w/index.php%3ftitle=User:Marc_van_Leeuwen&action=edit&redlink=1
209 <https://en.wikibooks.org/wiki/User:Marky1991~enwikibooks>
210 <https://en.wikibooks.org/wiki/User:Marudubshinki>
211 <https://en.wikibooks.org/w/index.php%3ftitle=User:Mathnerd314159&action=edit&redlink=1>
212 <https://en.wikibooks.org/w/index.php%3ftitle=User:Mattcox&action=edit&redlink=1>

- 3 Matěj Grabovský²¹³
- 1 Mgm7734²¹⁴
- 2 Michael miceli²¹⁵
- 1 Miegir²¹⁶
- 1 Mike²¹⁷
- 27 Mike Linksvayer²¹⁸
- 1 Mikeyo~enwikibooks²¹⁹
- 2 Miroslav65²²⁰
- 1 Miyoko Moua²²¹
- 1 Mjkaye²²²
- 1 Mk2366²²³
- 2 Mokendall²²⁴
- 9 Msouth²²⁵
- 5 Mvanier²²⁶
- 6 Mx4492²²⁷
- 5 Nabetse²²⁸
- 3 Narendraj9²²⁹
- 1 Nathanielvirgo²³⁰
- 8 Nattfodd²³¹
- 2 Neodymion~enwikibooks²³²
- 1 Ner0x652²³³
- 2 Nicball²³⁴
- 1 Nikai²³⁵
- 1 Nikiriy²³⁶

-
- 213 https://en.wikibooks.org/wiki/User:Mat%25C4%259Bj_Grabovsk%25C3%25BD
 - 214 <https://en.wikibooks.org/w/index.php%3ftitle=User:Mgm7734&action=edit&redlink=1>
 - 215 https://en.wikibooks.org/w/index.php%3ftitle=User:Michael_miceli&action=edit&redlink=1
 - 216 <https://en.wikibooks.org/w/index.php%3ftitle=User:Miegir&action=edit&redlink=1>
 - 217 <https://en.wikibooks.org/wiki/User:Mike>
 - 218 https://en.wikibooks.org/wiki/User:Mike_Linksvayer
 - 219 <https://en.wikibooks.org/w/index.php%3ftitle=User:Mikeyo~enwikibooks&action=edit&redlink=1>
 - 220 <https://en.wikibooks.org/w/index.php%3ftitle=User:Miroslav65&action=edit&redlink=1>
 - 221 https://en.wikibooks.org/w/index.php%3ftitle=User:Miyoko_Moua&action=edit&redlink=1
 - 222 <https://en.wikibooks.org/wiki/User:Mjkaye>
 - 223 <https://en.wikibooks.org/w/index.php%3ftitle=User:Mk2366&action=edit&redlink=1>
 - 224 <https://en.wikibooks.org/w/index.php%3ftitle=User:Mokendall&action=edit&redlink=1>
 - 225 <https://en.wikibooks.org/wiki/User:Msouth>
 - 226 <https://en.wikibooks.org/w/index.php%3ftitle=User:Mvanier&action=edit&redlink=1>
 - 227 <https://en.wikibooks.org/w/index.php%3ftitle=User:Mx4492&action=edit&redlink=1>
 - 228 <https://en.wikibooks.org/w/index.php%3ftitle=User:Nabetse&action=edit&redlink=1>
 - 229 <https://en.wikibooks.org/w/index.php%3ftitle=User:Narendraj9&action=edit&redlink=1>
 - 230 <https://en.wikibooks.org/w/index.php%3ftitle=User:Nathanielvirgo&action=edit&redlink=1>
 - 231 <https://en.wikibooks.org/wiki/User:Nattfodd>
 - 232 <https://en.wikibooks.org/w/index.php%3ftitle=User:Neodymion~enwikibooks&action=edit&redlink=1>
 - 233 <https://en.wikibooks.org/w/index.php%3ftitle=User:Ner0x652&action=edit&redlink=1>
 - 234 <https://en.wikibooks.org/w/index.php%3ftitle=User:Nicball&action=edit&redlink=1>
 - 235 <https://en.wikibooks.org/wiki/User:Nikai>
 - 236 <https://en.wikibooks.org/w/index.php%3ftitle=User:Nikiriy&action=edit&redlink=1>

- 2 Notnowplease²³⁷
- 2 Nyuszika7H²³⁸
- 1 Ob ivan²³⁹
- 1 Oblosys²⁴⁰
- 3 Obscaenvs²⁴¹
- 2 Oddron²⁴²
- 2 Oligomous²⁴³
- 1 Ondra~enwikibooks²⁴⁴
- 16 Orzetto~enwikibooks²⁴⁵
- 2 Oxryly²⁴⁶
- 1 Pakanek²⁴⁷
- 1 Palec90²⁴⁸
- 2 PandaMittens²⁴⁹
- 16 Panic2k4²⁵⁰
- 1 Paolino~enwikibooks²⁵¹
- 1 Pastafarianist²⁵²
- 2 Patriques82²⁵³
- 1 Paul.kline²⁵⁴
- 67 PaulJohnson²⁵⁵
- 1 Peterbaumgarten²⁵⁶
- 1 Peterwhy²⁵⁷
- 4 Physis²⁵⁸
- 5 Pi zero²⁵⁹
- 1 Pingveno²⁶⁰

237 <https://en.wikibooks.org/w/index.php%3ftitle=User:Notnowplease&action=edit&redlink=1>

238 <https://en.wikibooks.org/wiki/User:Nyuszika7H>

239 https://en.wikibooks.org/w/index.php%3ftitle=User:Ob_ivan&action=edit&redlink=1

240 <https://en.wikibooks.org/w/index.php%3ftitle=User:Oblosys&action=edit&redlink=1>

241 <https://en.wikibooks.org/w/index.php%3ftitle=User:Obscaenvs&action=edit&redlink=1>

242 <https://en.wikibooks.org/w/index.php%3ftitle=User:Oddron&action=edit&redlink=1>

243 <https://en.wikibooks.org/w/index.php%3ftitle=User:Oligomous&action=edit&redlink=1>

244 <https://en.wikibooks.org/w/index.php%3ftitle=User:Ondra~enwikibooks&action=edit&redlink=1>

245 <https://en.wikibooks.org/w/index.php%3ftitle=User:Orzetto~enwikibooks&action=edit&redlink=1>

246 <https://en.wikibooks.org/w/index.php%3ftitle=User:Oxryly&action=edit&redlink=1>

247 <https://en.wikibooks.org/w/index.php%3ftitle=User:Pakanek&action=edit&redlink=1>

248 <https://en.wikibooks.org/w/index.php%3ftitle=User:Palec90&action=edit&redlink=1>

249 <https://en.wikibooks.org/w/index.php%3ftitle=User:PandaMittens&action=edit&redlink=1>

250 <https://en.wikibooks.org/wiki/User:Panic2k4>

251 <https://en.wikibooks.org/w/index.php%3ftitle=User:Paolino~enwikibooks&action=edit&redlink=1>

252 <https://en.wikibooks.org/w/index.php%3ftitle=User:Pastafarianist&action=edit&redlink=1>

253 <https://en.wikibooks.org/wiki/User:Patriques82>

254 <https://en.wikibooks.org/w/index.php%3ftitle=User:Paul.kline&action=edit&redlink=1>

255 <https://en.wikibooks.org/w/index.php%3ftitle=User:PaulJohnson&action=edit&redlink=1>

256 <https://en.wikibooks.org/w/index.php%3ftitle=User:Peterbaumgarten&action=edit&redlink=1>

257 <https://en.wikibooks.org/w/index.php%3ftitle=User:Peterwhy&action=edit&redlink=1>

258 <https://en.wikibooks.org/wiki/User:Physis>

259 https://en.wikibooks.org/wiki/User:Pi_zero

260 <https://en.wikibooks.org/wiki/User:Pingveno>

5 Piojo~enwikibooks²⁶¹
1 Plattyaj²⁶²
1 Pmags²⁶³
1 PokestarFan²⁶⁴
2 PokestarFanBot²⁶⁵
1 Polypus74²⁶⁶
1 Prmaple²⁶⁷
1 Pseafield²⁶⁸
1 Pshook²⁶⁹
1 Punkouter²⁷⁰
2 Pupeno²⁷¹
5 Qeny²⁷²
1 QrBh5nqqq0svWlVr²⁷³
1 Qrilka²⁷⁴
19 Qundle²⁷⁵
13 QuiteUnusual²⁷⁶
2 Qwertyus²⁷⁷
2 Rahiel?²⁷⁸
6 Randallbritten²⁷⁹
1 Raneksi²⁸⁰
8 Rastus Vernon²⁸¹
1 Ravichandar84²⁸²
1 Rdragn²⁸³
2 Recent Runes²⁸⁴
1 Reedmb²⁸⁵

261 <https://en.wikibooks.org/w/index.php%3ftitle=User:Piojo~enwikibooks&action=edit&redlink=1>
262 <https://en.wikibooks.org/w/index.php%3ftitle=User:Plattyaj&action=edit&redlink=1>
263 <https://en.wikibooks.org/w/index.php%3ftitle=User:Pmags&action=edit&redlink=1>
264 <https://en.wikibooks.org/wiki/User:PokestarFan>
265 <https://en.wikibooks.org/wiki/User:PokestarFanBot>
266 <https://en.wikibooks.org/w/index.php%3ftitle=User:Polypus74&action=edit&redlink=1>
267 <https://en.wikibooks.org/w/index.php%3ftitle=User:Prmaple&action=edit&redlink=1>
268 <https://en.wikibooks.org/w/index.php%3ftitle=User:Pseafield&action=edit&redlink=1>
269 <https://en.wikibooks.org/w/index.php%3ftitle=User:Pshook&action=edit&redlink=1>
270 <https://en.wikibooks.org/w/index.php%3ftitle=User:Punkouter&action=edit&redlink=1>
271 <https://en.wikibooks.org/w/index.php%3ftitle=User:Pupeno&action=edit&redlink=1>
272 <https://en.wikibooks.org/w/index.php%3ftitle=User:Qeny&action=edit&redlink=1>
273 <https://en.wikibooks.org/w/index.php%3ftitle=User:QrBh5nqqq0svWlVr&action=edit&redlink=1>
274 <https://en.wikibooks.org/w/index.php%3ftitle=User:Qrilka&action=edit&redlink=1>
275 <https://en.wikibooks.org/w/index.php%3ftitle=User:Qundle&action=edit&redlink=1>
276 <https://en.wikibooks.org/wiki/User:QuiteUnusual>
277 <https://en.wikibooks.org/wiki/User:Qwertyus>
278 <https://en.wikibooks.org/w/index.php%3ftitle=User:Rahiel%253F&action=edit&redlink=1>
279 <https://en.wikibooks.org/w/index.php%3ftitle=User:Randallbritten&action=edit&redlink=1>
280 <https://en.wikibooks.org/w/index.php%3ftitle=User:Raneksi&action=edit&redlink=1>
281 https://en.wikibooks.org/w/index.php%3ftitle=User:Rastus_Vernon&action=edit&redlink=1
282 <https://en.wikibooks.org/wiki/User:Ravichandar84>
283 <https://en.wikibooks.org/w/index.php%3ftitle=User:Rdragn&action=edit&redlink=1>
284 https://en.wikibooks.org/wiki/User:Recent_Runes
285 <https://en.wikibooks.org/w/index.php%3ftitle=User:Reedmb&action=edit&redlink=1>

- 1 Renick²⁸⁶
- 2 Revence27~enwikibooks²⁸⁷
- 2 Risteall²⁸⁸
- 1 Robert Matthews²⁸⁹
- 1 RoelVanDijk²⁹⁰
- 2 Royote²⁹¹
- 39 Rudis²⁹²
- 1 Ruud Koot²⁹³
- 1 Ryk²⁹⁴
- 3 S489²⁹⁵
- 2 SBareSSomErMig²⁹⁶
- 1 SQL²⁹⁷
- 1 Saibod²⁹⁸
- 1 Salah.khairy²⁹⁹
- 1 SamIAMNot³⁰⁰
- 2 Sanyam³⁰¹
- 1 Sapiens scriptor³⁰²
- 14 Sarabander³⁰³
- 1 Schoenfinkel³⁰⁴
- 1 Scvalex³⁰⁵
- 1 Sebastian Goll³⁰⁶
- 1 Seusschef³⁰⁷
- 1 Sgronblo³⁰⁸
- 1 Shenme³⁰⁹
- 1 Shock one³¹⁰

- 286 <https://en.wikibooks.org/w/index.php?ftitle=User:Renick&action=edit&redlink=1>
- 287 <https://en.wikibooks.org/w/index.php?ftitle=User:Revence27~enwikibooks&action=edit&redlink=1>
- 288 <https://en.wikibooks.org/wiki/User:Risteall>
- 289 https://en.wikibooks.org/wiki/User:Robert_Matthews
- 290 <https://en.wikibooks.org/w/index.php?ftitle=User:RoelVanDijk&action=edit&redlink=1>
- 291 <https://en.wikibooks.org/w/index.php?ftitle=User:Royote&action=edit&redlink=1>
- 292 <https://en.wikibooks.org/w/index.php?ftitle=User:Rudis&action=edit&redlink=1>
- 293 https://en.wikibooks.org/wiki/User:Ruud_Koot
- 294 <https://en.wikibooks.org/w/index.php?ftitle=User:Ryk&action=edit&redlink=1>
- 295 <https://en.wikibooks.org/w/index.php?ftitle=User:S489&action=edit&redlink=1>
- 296 <https://en.wikibooks.org/w/index.php?ftitle=User:SBareSSomErMig&action=edit&redlink=1>
- 297 <https://en.wikibooks.org/wiki/User:SQL>
- 298 <https://en.wikibooks.org/w/index.php?ftitle=User:Saibod&action=edit&redlink=1>
- 299 <https://en.wikibooks.org/w/index.php?ftitle=User:Salah.khairy&action=edit&redlink=1>
- 300 <https://en.wikibooks.org/w/index.php?ftitle=User:SamIAMNot&action=edit&redlink=1>
- 301 <https://en.wikibooks.org/w/index.php?ftitle=User:Sanyam&action=edit&redlink=1>
- 302 https://en.wikibooks.org/w/index.php?ftitle=User:Sapiens_scriptor&action=edit&redlink=1
- 303 <https://en.wikibooks.org/w/index.php?ftitle=User:Sarabander&action=edit&redlink=1>
- 304 <https://en.wikibooks.org/w/index.php?ftitle=User:Schoenfinkel&action=edit&redlink=1>
- 305 <https://en.wikibooks.org/w/index.php?ftitle=User:Scvalex&action=edit&redlink=1>
- 306 https://en.wikibooks.org/wiki/User:Sebastian_Goll
- 307 <https://en.wikibooks.org/w/index.php?ftitle=User:Seusschef&action=edit&redlink=1>
- 308 <https://en.wikibooks.org/w/index.php?ftitle=User:Sgronblo&action=edit&redlink=1>
- 309 <https://en.wikibooks.org/wiki/User:Shenme>
- 310 https://en.wikibooks.org/w/index.php?ftitle=User:Shock_one&action=edit&redlink=1

- 1 Sibi.lam³¹¹
- 19 SimonMichael³¹²
- 1 Siteswapper³¹³
- 1 Smcpeak³¹⁴
- 5 Snarius~enwikibooks³¹⁵
- 1 Snowolf³¹⁶
- 2 Snoyberg³¹⁷
- 1 Some1~enwikibooks³¹⁸
- 9 Spammaxx³¹⁹
- 2 Spockwang³²⁰
- 3 Spookylukey~enwikibooks³²¹
- 10 Sqdcn³²²
- 9 Sridca³²³
- 2 Stateless~enwikibooks³²⁴
- 1 SteloKim~enwikibooks³²⁵
- 1 Stereotype441³²⁶
- 13 Stevelihn~enwikibooks³²⁷
- 5 Ste~enwikibooks³²⁸
- 4 Strange quark³²⁹
- 4 Stuhacking~enwikibooks³³⁰
- 7 Stw³³¹
- 15 Sudozero³³²
- 1 Sullivan-³³³
- 1 Sumant.nk³³⁴

-
- 311 <https://en.wikibooks.org/w/index.php?ftitle=User:Sibi.lam&action=edit&redlink=1>
 - 312 <https://en.wikibooks.org/w/index.php?ftitle=User:SimonMichael&action=edit&redlink=1>
 - 313 <https://en.wikibooks.org/w/index.php?ftitle=User:Siteswapper&action=edit&redlink=1>
 - 314 <https://en.wikibooks.org/w/index.php?ftitle=User:Smcpeak&action=edit&redlink=1>
 - 315 <https://en.wikibooks.org/wiki/User:Snarius~enwikibooks>
 - 316 <https://en.wikibooks.org/wiki/User:Snowolf>
 - 317 <https://en.wikibooks.org/w/index.php?ftitle=User:Snoyberg&action=edit&redlink=1>
 - 318 <https://en.wikibooks.org/w/index.php?ftitle=User:Some1~enwikibooks&action=edit&redlink=1>
 - 319 <https://en.wikibooks.org/w/index.php?ftitle=User:Spammaxx&action=edit&redlink=1>
 - 320 <https://en.wikibooks.org/w/index.php?ftitle=User:Spockwang&action=edit&redlink=1>
 - 321 <https://en.wikibooks.org/w/index.php?ftitle=User:Spookylukey~enwikibooks&action=edit&redlink=1>
 - 322 <https://en.wikibooks.org/wiki/User:Sqdcn>
 - 323 <https://en.wikibooks.org/wiki/User:Sridca>
 - 324 <https://en.wikibooks.org/w/index.php?ftitle=User:Stateless~enwikibooks&action=edit&redlink=1>
 - 325 <https://en.wikibooks.org/w/index.php?ftitle=User:SteloKim~enwikibooks&action=edit&redlink=1>
 - 326 <https://en.wikibooks.org/wiki/User:Stereotype441>
 - 327 <https://en.wikibooks.org/w/index.php?ftitle=User:Stevelihn~enwikibooks&action=edit&redlink=1>
 - 328 <https://en.wikibooks.org/w/index.php?ftitle=User:Ste~enwikibooks&action=edit&redlink=1>
 - 329 https://en.wikibooks.org/wiki/User:Strange_quark
 - 330 <https://en.wikibooks.org/wiki/User:Stuhacking~enwikibooks>
 - 331 <https://en.wikibooks.org/wiki/User:Stw>
 - 332 <https://en.wikibooks.org/wiki/User:Sudozero>
 - 333 <https://en.wikibooks.org/w/index.php?ftitle=User:Sullivan-&action=edit&redlink=1>
 - 334 <https://en.wikibooks.org/w/index.php?ftitle=User:Sumant.nk&action=edit&redlink=1>

8	Svick ³³⁵
1	Swift ³³⁶
1	TJ schulte ³³⁷
1	Tanuki647 ³³⁸
1	Taylor561 ³³⁹
62	Tchakkazulu ³⁴⁰
1	Tea2min ³⁴¹
1	Teval~enwikibooks ³⁴²
1	TheBlueBlur ³⁴³
4	Thejoshwolfe ³⁴⁴
1	Timp21337 ³⁴⁵
2	Tinmarks ³⁴⁶
3	TittoAssini~enwikibooks ³⁴⁷
10	Toby Bartels ³⁴⁸
2	TomFitzhenry~enwikibooks ³⁴⁹
1	Trannart ³⁵⁰
1	Trinithis ³⁵¹
1	Trzkiril ³⁵²
1	TurionTzukosson ³⁵³
2	Turtur~enwikibooks ³⁵⁴
2	Twelvefifty ³⁵⁵
27	Uchchwhash~enwikibooks ³⁵⁶
3	Uebayasi ³⁵⁷
1	Unimaginable666~enwikibooks ³⁵⁸

335 <https://en.wikibooks.org/w/index.php?3ftitle=User:Svick&action=edit&redlink=1>

336 <https://en.wikibooks.org/wiki/User:Swift>

337 https://en.wikibooks.org/w/index.php?3ftitle=User:TJ_schulte&action=edit&redlink=1

338 <https://en.wikibooks.org/w/index.php?3ftitle=User:Tanuki647&action=edit&redlink=1>

339 <https://en.wikibooks.org/w/index.php?3ftitle=User:Taylor561&action=edit&redlink=1>

340 <https://en.wikibooks.org/wiki/User:Tchakkazulu>

341 <https://en.wikibooks.org/w/index.php?3ftitle=User:Tea2min&action=edit&redlink=1>

342 <https://en.wikibooks.org/w/index.php?3ftitle=User:Teval~enwikibooks&action=edit&redlink=1>

343 <https://en.wikibooks.org/w/index.php?3ftitle=User:TheBlueBlur&action=edit&redlink=1>

344 <https://en.wikibooks.org/w/index.php?3ftitle=User:Thejoshwolfe&action=edit&redlink=1>

345 <https://en.wikibooks.org/w/index.php?3ftitle=User:Timp21337&action=edit&redlink=1>

346 <https://en.wikibooks.org/w/index.php?3ftitle=User:Tinmarks&action=edit&redlink=1>

347 <https://en.wikibooks.org/w/index.php?3ftitle=User:TittoAssini~enwikibooks&action=edit&redlink=1>

348 https://en.wikibooks.org/wiki/User:Toby_Bartels

349 <https://en.wikibooks.org/w/index.php?3ftitle=User:TomFitzhenry~enwikibooks&action=edit&redlink=1>

350 <https://en.wikibooks.org/w/index.php?3ftitle=User:Trannart&action=edit&redlink=1>

351 <https://en.wikibooks.org/w/index.php?3ftitle=User:Trinithis&action=edit&redlink=1>

352 <https://en.wikibooks.org/w/index.php?3ftitle=User:Trzkiril&action=edit&redlink=1>

353 <https://en.wikibooks.org/w/index.php?3ftitle=User:TurionTzukosson&action=edit&redlink=1>

354 <https://en.wikibooks.org/w/index.php?3ftitle=User:Turtur~enwikibooks&action=edit&redlink=1>

355 <https://en.wikibooks.org/w/index.php?3ftitle=User:Twelvefifty&action=edit&redlink=1>

356 <https://en.wikibooks.org/w/index.php?3ftitle=User:Uchchwhash~enwikibooks&action=edit&redlink=1>

357 <https://en.wikibooks.org/w/index.php?3ftitle=User:Uebayasi&action=edit&redlink=1>

358 <https://en.wikibooks.org/w/index.php?3ftitle=User:Unimaginable666~enwikibooks&action=edit&redlink=1>

- 1 VU3RDD³⁵⁹
- 3 Van der Hoorn³⁶⁰
- 1 VernonF³⁶¹
- 2 Vesal³⁶²
- 2 Vincent cloutier³⁶³
- 1 Virgilsamms³⁶⁴
- 7 WOSlinker³⁶⁵
- 1 Walkie³⁶⁶
- 3 Wapcaplet~enwikibooks³⁶⁷
- 17 Wei2912³⁶⁸
- 1 Whym³⁶⁹
- 1 Will48³⁷⁰
- 26 WillNess³⁷¹
- 1 Withinfocus³⁷²
- 2 Wrmorris³⁷³
- 1 Xnn³⁷⁴
- 1 Xrchz³⁷⁵
- 1 Yanpas³⁷⁶
- 1 Zhangyutong926³⁷⁷
- 1 Zoonfafer³⁷⁸
- 1 Zr40³⁷⁹
- 9 ³⁸⁰
- 1 ³⁸¹

- 359 <https://en.wikibooks.org/w/index.php%3ftitle=User:VU3RDD&action=edit&redlink=1>
- 360 https://en.wikibooks.org/wiki/User:Van_der_Hoorn
- 361 <https://en.wikibooks.org/wiki/User:VernonF>
- 362 <https://en.wikibooks.org/w/index.php%3ftitle=User:Vesal&action=edit&redlink=1>
- 363 https://en.wikibooks.org/wiki/User:Vincent_cloutier
- 364 <https://en.wikibooks.org/wiki/User:Virgilsamms>
- 365 <https://en.wikibooks.org/w/index.php%3ftitle=User:WOSlinker&action=edit&redlink=1>
- 366 <https://en.wikibooks.org/w/index.php%3ftitle=User:Walkie&action=edit&redlink=1>
- 367 <https://en.wikibooks.org/w/index.php%3ftitle=User:Wapcaplet~enwikibooks&action=edit&redlink=1>
- 368 <https://en.wikibooks.org/w/index.php%3ftitle=User:Wei2912&action=edit&redlink=1>
- 369 <https://en.wikibooks.org/wiki/User:Whym>
- 370 <https://en.wikibooks.org/wiki/User:Will48>
- 371 <https://en.wikibooks.org/wiki/User:WillNess>
- 372 <https://en.wikibooks.org/wiki/User:Withinfocus>
- 373 <https://en.wikibooks.org/w/index.php%3ftitle=User:Wrmorris&action=edit&redlink=1>
- 374 <https://en.wikibooks.org/w/index.php%3ftitle=User:Xnn&action=edit&redlink=1>
- 375 <https://en.wikibooks.org/w/index.php%3ftitle=User:Xrchz&action=edit&redlink=1>
- 376 <https://en.wikibooks.org/w/index.php%3ftitle=User:Yanpas&action=edit&redlink=1>
- 377 <https://en.wikibooks.org/w/index.php%3ftitle=User:Zhangyutong926&action=edit&redlink=1>
- 378 <https://en.wikibooks.org/w/index.php%3ftitle=User:Zoonfafer&action=edit&redlink=1>
- 379 <https://en.wikibooks.org/w/index.php%3ftitle=User:Zr40&action=edit&redlink=1>
- 380 <https://en.wikibooks.org/w/index.php%3ftitle=User:%25D7%25A0%25D7%2594%25D7%2590%25D7%259C&action=edit&redlink=1>
- 381 <https://en.wikibooks.org/w/index.php%3ftitle=User:%25D7%25A4%25D7%25A8%25D7%2594&action=edit&redlink=1>

List of Figures

- GFDL: Gnu Free Documentation License. <http://www.gnu.org/licenses/fdl.html>
- cc-by-sa-3.0: Creative Commons Attribution ShareAlike 3.0 License. <http://creativecommons.org/licenses/by-sa/3.0/>
- cc-by-sa-2.5: Creative Commons Attribution ShareAlike 2.5 License. <http://creativecommons.org/licenses/by-sa/2.5/>
- cc-by-sa-2.0: Creative Commons Attribution ShareAlike 2.0 License. <http://creativecommons.org/licenses/by-sa/2.0/>
- cc-by-sa-1.0: Creative Commons Attribution ShareAlike 1.0 License. <http://creativecommons.org/licenses/by-sa/1.0/>
- cc-by-2.0: Creative Commons Attribution 2.0 License. <http://creativecommons.org/licenses/by/2.0/>
- cc-by-2.0: Creative Commons Attribution 2.0 License. <http://creativecommons.org/licenses/by/2.0/deed.en>
- cc-by-2.5: Creative Commons Attribution 2.5 License. <http://creativecommons.org/licenses/by/2.5/deed.en>
- cc-by-3.0: Creative Commons Attribution 3.0 License. <http://creativecommons.org/licenses/by/3.0/deed.en>
- GPL: GNU General Public License. <http://www.gnu.org/licenses/gpl-2.0.txt>
- LGPL: GNU Lesser General Public License. <http://www.gnu.org/licenses/lgpl.html>
- PD: This image is in the public domain.
- ATTR: The copyright holder of this file allows anyone to use it for any purpose, provided that the copyright holder is properly attributed. Redistribution, derivative work, commercial use, and all other use is permitted.
- EURO: This is the common (reverse) face of a euro coin. The copyright on the design of the common face of the euro coins belongs to the European Commission. Authorised is reproduction in a format without relief (drawings, paintings, films) provided they are not detrimental to the image of the euro.
- LFK: Lizenz Freie Kunst. <http://artlibre.org/licence/lal/de>
- CFR: Copyright free use.

- EPL: Eclipse Public License. <http://www.eclipse.org/org/documents/epl-v10.php>

Copies of the GPL, the LGPL as well as a GFDL are included in chapter Licenses³⁸². Please note that images in the public domain do not require attribution. You may click on the image numbers in the following table to open the webpage of the images in your webbrowser.

³⁸² Chapter 92 on page 653

1	Leftaroundabout ³⁸³ , Leftaroundabout ³⁸⁴	
2	Gaz ³⁸⁵ at English Wikipedia ³⁸⁶	
3	An Errant Knight, Cyberpunk, Drilnoth, Emijrpbot, Hazard-Bot, JarektBot, Juiced lemon, Mindmatrix	
4	Randall Britten ³⁸⁷ , Randall Britten ³⁸⁸	
5	Daniel Mlot ³⁸⁹ , Daniel Mlot ³⁹⁰	
6	No machine-readable author provided. Kowey ³⁹¹ assumed (based on copyright claims)., No machine-readable author provided. Kowey ³⁹² assumed (based on copyright claims).	
7	No machine-readable author provided. Kowey ³⁹³ assumed (based on copyright claims)., No machine-readable author provided. Kowey ³⁹⁴ assumed (based on copyright claims).	
8	No machine-readable author provided. Kowey ³⁹⁵ assumed (based on copyright claims)., No machine-readable author provided. Kowey ³⁹⁶ assumed (based on copyright claims).	
9	No machine-readable author provided. Kowey ³⁹⁷ assumed (based on copyright claims)., No machine-readable author provided. Kowey ³⁹⁸ assumed (based on copyright claims).	
10	No machine-readable author provided. Kowey ³⁹⁹ assumed (based on copyright claims)., No machine-readable author provided. Kowey ⁴⁰⁰ assumed (based on copyright claims).	
11	No machine-readable author provided. Kowey ⁴⁰¹ assumed (based on copyright claims)., No machine-readable author provided. Kowey ⁴⁰² assumed (based on copyright claims).	
12	Daniel Mlot ⁴⁰³ , Daniel Mlot ⁴⁰⁴	
13	Daniel Mlot ⁴⁰⁵ , Daniel Mlot ⁴⁰⁶	

383 <http://commons.wikimedia.org/w/index.php?title=User:Leftaroundabout&action=edit&redlink=1>

384 <https://commons.wikimedia.org/w/index.php?title=User:Leftaroundabout&action=edit&redlink=1>

385 <https://en.wikipedia.org/wiki/User:Gaz>

386 <https://en.wikipedia.org/wiki/>

387 <http://commons.wikimedia.org/w/index.php?title=User:Randallbritten&action=edit&redlink=1>

388 <https://commons.wikimedia.org/w/index.php?title=User:Randallbritten&action=edit&redlink=1>

389 <http://commons.wikimedia.org/wiki/User:Duplode>

390 <https://commons.wikimedia.org/wiki/User:Duplode>

391 <http://commons.wikimedia.org/wiki/User:Kowey>

392 <https://commons.wikimedia.org/wiki/User:Kowey>

393 <http://commons.wikimedia.org/wiki/User:Kowey>

394 <https://commons.wikimedia.org/wiki/User:Kowey>

395 <http://commons.wikimedia.org/wiki/User:Kowey>

396 <https://commons.wikimedia.org/wiki/User:Kowey>

397 <http://commons.wikimedia.org/wiki/User:Kowey>

398 <https://commons.wikimedia.org/wiki/User:Kowey>

399 <http://commons.wikimedia.org/wiki/User:Kowey>

400 <https://commons.wikimedia.org/wiki/User:Kowey>

401 <http://commons.wikimedia.org/wiki/User:Kowey>

402 <https://commons.wikimedia.org/wiki/User:Kowey>

403 <http://commons.wikimedia.org/wiki/User:Duplode>

404 <https://commons.wikimedia.org/wiki/User:Duplode>

405 <http://commons.wikimedia.org/wiki/User:Duplode>

406 <https://commons.wikimedia.org/wiki/User:Duplode>

14	Apfelmus ⁴⁰⁷ at English Wikibooks ⁴⁰⁸	
15	Apfelmus ⁴⁰⁹ at English Wikibooks ⁴¹⁰	
16	Apfelmus ⁴¹¹ at English Wikibooks ⁴¹²	
17	Apfelmus ⁴¹³ at English Wikibooks ⁴¹⁴	
18	Apfelmus ⁴¹⁵ at English Wikibooks ⁴¹⁶	
19	Apfelmus ⁴¹⁷ at English Wikibooks ⁴¹⁸	
20	Apfelmus ⁴¹⁹ at English Wikibooks ⁴²⁰	
21	en:Apfelmus ⁴²¹	
22	Apfelmus ⁴²² at English Wikibooks ⁴²³	
23	Apfelmus ⁴²⁴ at English Wikibooks ⁴²⁵	
24	DavidHouse ⁴²⁶ at English Wikibooks ⁴²⁷	
25	DavidHouse ⁴²⁸ at English Wikibooks ⁴²⁹	
26	DavidHouse ⁴³⁰ at English Wikibooks ⁴³¹	
27	DavidHouse ⁴³² at English Wikibooks ⁴³³	
28	Svick ⁴³⁴ , Svick ⁴³⁵	
29	DavidHouse ⁴³⁶ at English Wikibooks ⁴³⁷	
30	DavidHouse ⁴³⁸ at English Wikibooks ⁴³⁹	
31	DavidHouse ⁴⁴⁰ at English Wikibooks ⁴⁴¹	

407 <https://en.wikibooks.org/wiki/User:Apfelmus>
408 <https://en.wikibooks.org/wiki/>
409 <https://en.wikibooks.org/wiki/User:Apfelmus>
410 <https://en.wikibooks.org/wiki/>
411 <https://en.wikibooks.org/wiki/User:Apfelmus>
412 <https://en.wikibooks.org/wiki/>
413 <https://en.wikibooks.org/wiki/User:Apfelmus>
414 <https://en.wikibooks.org/wiki/>
415 <https://en.wikibooks.org/wiki/User:Apfelmus>
416 <https://en.wikibooks.org/wiki/>
417 <https://en.wikibooks.org/wiki/User:Apfelmus>
418 <https://en.wikibooks.org/wiki/>
419 <https://en.wikibooks.org/wiki/User:Apfelmus>
420 <https://en.wikibooks.org/wiki/>
421 <https://en.wikibooks.org/wiki/en:Apfelmus>
422 <https://en.wikibooks.org/wiki/User:Apfelmus>
423 <https://en.wikibooks.org/wiki/>
424 <https://en.wikibooks.org/wiki/User:Apfelmus>
425 <https://en.wikibooks.org/wiki/>
426 <https://en.wikibooks.org/wiki/User:DavidHouse>
427 <https://en.wikibooks.org/wiki/>
428 <https://en.wikibooks.org/wiki/User:DavidHouse>
429 <https://en.wikibooks.org/wiki/>
430 <https://en.wikibooks.org/wiki/User:DavidHouse>
431 <https://en.wikibooks.org/wiki/>
432 <https://en.wikibooks.org/wiki/User:DavidHouse>
433 <https://en.wikibooks.org/wiki/>
434 <http://commons.wikimedia.org/wiki/User:Svick>
435 <https://commons.wikimedia.org/wiki/User:Svick>
436 <https://en.wikibooks.org/wiki/User:DavidHouse>
437 <https://en.wikibooks.org/wiki/>
438 <https://en.wikibooks.org/wiki/User:DavidHouse>
439 <https://en.wikibooks.org/wiki/>
440 <https://en.wikibooks.org/wiki/User:DavidHouse>
441 <https://en.wikibooks.org/wiki/>

32	DavidHouse ⁴⁴² at English Wikibooks ⁴⁴³	
33	DavidHouse ⁴⁴⁴ at English Wikibooks ⁴⁴⁵	
34	DavidHouse ⁴⁴⁶ at English Wikibooks ⁴⁴⁷	
35	DavidHouse ⁴⁴⁸ , DavidHouse ⁴⁴⁹	
36	DavidHouse ⁴⁵⁰ , DavidHouse ⁴⁵¹	
37	Tchakkazulu	
38	Tchakkazulu	
39	Tchakkazulu	
40	Tchakkazulu	
41	Tchakkazulu	
42	Tchakkazulu	
43	Tchakkazulu	

442 <https://en.wikibooks.org/wiki/User:DavidHouse>

443 <https://en.wikibooks.org/wiki/>

444 <https://en.wikibooks.org/wiki/User:DavidHouse>

445 <https://en.wikibooks.org/wiki/>

446 <https://en.wikibooks.org/wiki/User:DavidHouse>

447 <https://en.wikibooks.org/wiki/>

448 <http://commons.wikimedia.org/w/index.php?title=User:DavidHouse&action=edit&redlink=1>

449 <https://commons.wikimedia.org/w/index.php?title=User:DavidHouse&action=edit&redlink=1>

450 <http://commons.wikimedia.org/w/index.php?title=User:DavidHouse&action=edit&redlink=1>

451 <https://commons.wikimedia.org/w/index.php?title=User:DavidHouse&action=edit&redlink=1>

92 Licenses

92.1 GNU GENERAL PUBLIC LICENSE

Version 3, 29 June 2007

Copyright © 2007 Free Software Foundation, Inc. <<http://fsf.org/>>

Everyone is permitted to copy and distribute verbatim copies of this license document, but changing it is not allowed. Preamble

The GNU General Public License is a free, copyleft license for software and other kinds of works.

The licenses for most software and other practical works are designed to take away your freedom to share and change the works. By contrast, the GNU General Public License is intended to guarantee your freedom to share and change all versions of a program—to make sure it remains free software for all its users. We, the Free Software Foundation, use the GNU General Public License for most of our software; it applies also to any other work released this way by its authors. You can apply it to your programs, too.

When we speak of free software, we are referring to freedom, not price. Our General Public Licenses are designed to make sure that you have the freedom to distribute copies of free software (and charge for them if you wish), that you receive source code or can get it if you want it, that you can change the software or use pieces of it in new free programs, and that you know you can do these things.

To protect your rights, we need to prevent others from denying you these rights or asking you to surrender the rights. Therefore, you have certain responsibilities if you distribute copies of the software, or if you modify it: responsibilities to respect the freedom of others.

For example, if you distribute copies of such a program, whether gratis or for a fee, you must pass on to the recipients the same freedoms that you received. You must make sure that they, too, receive or can get the source code. And you must show them these terms so they know their rights.

Developers that use the GNU GPL protect your rights with two steps: (1) assert copyright on the software, and (2) offer you this License giving you legal permission to copy, distribute and/or modify it.

For the developers' and authors' protection, the GPL clearly explains that there is no warranty for this free software. For both users' and authors' sake, the GPL requires that modified versions be marked as changed, so that their problems will not be attributed erroneously to authors of previous versions.

Some devices are designed to deny users access to install or run modified versions of the software inside them, although the manufacturer can do so. This is fundamentally incompatible with the aim of protecting users' freedom to change the software. The systematic pattern of such abuse occurs in the area of products for individuals to use, which is precisely where it is most unacceptable. Therefore, we have designed this version of the GPL to prohibit the practice for those products. If such problems arise substantially in other domains, we stand ready to extend this provision to those domains in future versions of the GPL, as needed to protect the freedom of users.

Finally, every program is threatened constantly by software patents. States should not allow patents to restrict development and use of software on general-purpose computers, but in those that do, we wish to avoid the special danger that patents applied to a free program could make it effectively proprietary. To prevent this, the GPL assures that patents cannot be used to render the program non-free.

The precise terms and conditions for copying, distribution and modification follow. TERMS AND CONDITIONS 0. Definitions.

"This License" refers to version 3 of the GNU General Public License.

"Copyright" also means copyright-like laws that apply to other kinds of works, such as semiconductor masks.

"The Program" refers to any copyrightable work licensed under this License. Each licensee is addressed as "you". "Licensees" and "recipients" may be individuals or organizations.

To "modify" a work means to copy from or adapt all or part of the work in a fashion requiring copyright permission, other than the making of an exact copy. The resulting work is called a "modified version" of the earlier work or a work "based on" the earlier work.

A "covered work" means either the unmodified Program or a work based on the Program.

To "propagate" a work means to do anything with it that, without permission, would make you directly or secondarily liable for infringement under applicable copyright law, except executing it on a computer or modifying a private copy. Propagation includes copying, distribution (with or without modification), making available to the public, and in some countries other activities as well.

To "convey" a work means any kind of propagation that enables other parties to make or receive copies. Mere interaction with a user through a computer network, with no transfer of a copy, is not conveying.

An interactive user interface displays "Appropriate Legal Notices" to the extent that it includes a convenient and prominently visible feature that (1) displays an appropriate copyright notice, and (2) tells the user that there is no warranty for the work (except to the extent that warranties are provided), that licensees may convey the work under this License, and how to view a copy of this License. If the interface presents a list of user commands or options, such as a menu, a prominent item in the list meets this criterion. 1. Source Code.

The "source code" for a work means the preferred form of the work for making modifications to it. "Object code" means any non-source form of a work.

A "Standard Interface" means an interface that either is an official standard defined by a recognized standards body, or, in the case of interfaces specified for a particular programming language, one that is widely used among developers working in that language.

The "System Libraries" of an executable work include anything other than the work as a whole, that (a) is included in the normal form of packaging a Major Component, but which is not part of that Major Component, and (b) serves only to enable use of the work with that Major Component, or to implement a Standard Interface for which an implementation is available to the public in source code form. A "Major Component", in this context, means a major essential component (kernel, window system, and so on) of the specific operating system (if any) on which the executable work runs, or a compiler used to produce the work, or an object code interpreter used to run it.

The "Corresponding Source" for a work in object code form means all the source code needed to generate, install, and (for an executable work) run the object code and to modify the work, including scripts to control those activities. However, it does not include the work's System Libraries, or general-purpose tools or generally available free programs which are used unmodified in performing those activities but which are not part of the work. For example, Corresponding Source includes interface definition files associated with source files for the work, and the source code for shared libraries and dynamically linked subprograms that the work is specifically designed to require, such as by intimate data communication or control flow between those subprograms and other parts of the work.

The Corresponding Source need not include anything that users can regenerate automatically from other parts of the Corresponding Source.

The Corresponding Source for a work in source code form is that same work. 2. Basic Permissions.

All rights granted under this License are granted for the term of copyright on the Program, and are irrevocable provided the stated conditions are met. This License explicitly affirms your unlimited permission to run the unmodified Program. The output from running a covered work is covered by this License only if the output, given its content, constitutes a covered work. This License acknowledges your rights of fair use or other equivalent, as provided by copyright law.

You may make, run and propagate covered works that you do not convey, without conditions so long as your license otherwise remains in force. You may convey covered works to others for the sole purpose of having them make modifications exclusively for you, or provide you with facilities for running those works, provided that you comply with the terms of this License in conveying all material for which you do not control copyright. Those thus making or running the covered works for you must do so exclusively on your behalf, under your direction and control, on terms that prohibit them from making any copies of your copyrighted material outside their relationship with you.

Conveying under any other circumstances is permitted solely under the conditions stated below. Sublicensing is not allowed; section 10 makes it unnecessary. 3. Protecting Users' Legal Rights From Anti-Circumvention Law.

No covered work shall be deemed part of an effective technological measure under any applicable law fulfilling obligations under article 11 of the WIPO copyright treaty adopted on 20 December 1996, or similar laws prohibiting or restricting circumvention of such measures.

When you convey a covered work, you waive any legal power to forbid circumvention of technological measures to the extent such circumvention is effected by exercising rights under this License with respect to the covered work, and you disclaim any intention to limit operation or modification of the work as a means of enforcing, against the work's users, your or third parties' legal rights to forbid circumvention of technological measures. 4. Conveying Verbatim Copies.

You may convey verbatim copies of the Program's source code as you receive it, in any medium, provided that you conspicuously and appropriately publish on each copy an appropriate copyright notice; keep intact all notices stating that this License and any non-permissive terms added in accord with section 7 apply to the code; keep intact all notices of the absence of any warranty; and give all recipients a copy of this License along with the Program.

You may charge any price or no price for each copy that you convey, and you may offer support warranty protection for a fee. 5. Conveying Modified Source Versions.

You may convey a work based on the Program, or the modifications to produce it from the Program, in the form of source code under the terms of section 4, provided that you also meet all of these conditions:

* a) The work must carry prominent notices stating that you modified it, and giving a relevant date. * b) The work must carry prominent notices stating that it is released under this License and any conditions added under section 7. This requirement modifies the requirement in section 4 to "keep intact all notices". * c) You must license the entire work, as a whole, under this License to anyone who comes into possession of a copy. This License will therefore apply, along with any applicable section 7 additional terms, to the whole of the work, and all its parts, regardless of how they are packaged. This License gives no permission to license the work in any other way, but it does not invalidate such permission if you have separately received it. * d) If the work has interactive user interfaces, each must display Appropriate Legal Notices; however, if the Program has interactive interfaces that do not display Appropriate Legal Notices, your work need not make them do so.

A compilation of a covered work with other separate and independent works, which are not by their nature extensions of the covered work, and which are not combined with it such as to form a larger program, in or on a volume of a storage or distribution medium, is called an "aggregate" if the compilation and its resulting copyright are not used to limit the access or legal rights of the compilation's users beyond what the individual works permit. Inclusion of a covered work in an aggregate does not cause this License to apply to the other parts of the aggregate. 6. Conveying Non-Source Forms.

You may convey a covered work in object code form under the terms of sections 4 and 5, provided that you also convey the machine-readable Corresponding Source under the terms of this License, in one of these ways:

* a) Convey the object code in, or embodied in, a physical product (including a physical distribution medium), accompanied by the Corresponding Source fixed on a durable physical medium customarily used for software interchange. * b) Convey the object code in, or embodied in, a physical product (including a physical distribution medium), accompanied by a written offer, valid for at least three years and valid for as long as you offer spare parts or customer support for that product model, to give anyone who possesses the object code either (1) a copy of the Corresponding Source for all the software in the product that is covered by this License, on a durable physical medium customarily used for software interchange, for a price no more than your reasonable cost of physically performing this conveying of source, or (2) access to copy the Corresponding Source from a network server at no charge. * c) Convey individual copies of the object code with a copy of the written offer to provide the Corresponding Source. This alternative is allowed only occasionally and noncommercially, and only if you received the object code with such an offer, in accord with subsection 6b. * d) Convey the object code by offering access from a designated place (gratis or for a charge), and offer equivalent access to the Corresponding Source in the same way through the same place at no further charge. You need not require recipients to copy the Corresponding Source along with the object code. If the place to copy the object code is a network server, the Corresponding Source may be on a

different server (operated by you or a third party) that supports equivalent copying facilities, provided you maintain clear directions next to the object code saying where to find the Corresponding Source. Regardless of what server hosts the Corresponding Source, you remain obligated to ensure that it is available for as long as needed to satisfy these requirements. * e) Convey the object code using peer-to-peer transmission, provided you inform other peers where the object code and Corresponding Source of the work are being offered to the general public at no charge under subsection 6d.

A separable portion of the object code, whose source code is excluded from the Corresponding Source as a System Library, need not be included in conveying the object code work.

A "User Product" is either (1) a "consumer product", which means any tangible personal property which is normally used for personal, family, or household purposes, or (2) anything designed or sold for incorporation into a dwelling. In determining whether a product is a consumer product, doubtful cases shall be resolved in favor of coverage. For a particular product received by a particular user, "normally used" refers to a typical or common use of that class of product, regardless of the status of the particular user or of the way in which the particular user actually uses, or expects to use, is expected to use, the product. A product is a consumer product regardless of whether the product has substantial commercial, industrial or non-consumer uses, unless such uses represent the only significant mode of use of the product.

"Installation Information" for a User Product means any methods, procedures, authorization keys, or other information required to install and execute modified versions of a covered work in that User Product from a modified version of its Corresponding Source. The information must suffice to ensure that the continued functioning of the modified object code is in no case prevented or interfered with solely because modification has been made.

If you specify an object code work under this section in, or with, or specifically for use in, a User Product, and the conveying occurs as part of a transaction in which the right of possession and use of the User Product is transferred to the recipient in perpetuity or for a fixed term (regardless of how the transaction is characterized), the Corresponding Source conveyed under this section must be accompanied by the Installation Information. But this requirement does not apply if neither you nor any third party retains the ability to install modified object code on the User Product (for example, the work has been installed in ROM).

The requirement to provide Installation Information does not include a requirement to continue to provide support services, warranty, or updates for a work that has been modified or installed by the recipient, or for the User Product in which it has been modified or installed. Access to a network may be denied when the modification itself materially and adversely affects the operation of the network or violates the rules and protocols for communication across the network.

Corresponding Source conveyed, and Installation Information provided, in accord with this section must be in a format that is publicly documented (and with an implementation available to the public in source code form), and must require no special password or key for unpacking, reading or copying. 7. Additional Terms.

"Additional permissions" are terms that supplement the terms of this License by making exceptions from one or more of its conditions. Additional permissions that are applicable to the entire Program shall be treated as though they were included in this License, to the extent that they are valid under applicable law. If additional permissions apply only to part of the Program, that part may be used separately under those permissions, but the entire Program remains governed by this License without regard to the additional permissions.

When you convey a copy of a covered work, you may at your option remove any additional permissions from that copy, or from any part of it. (Additional permissions may be written to require their own removal in certain cases when you modify the work.) You may place additional permissions on material, added by you to a covered work, for which you have or can give appropriate copyright permission.

Notwithstanding any other provision of this License, for material you add to a covered work, you may (if authorized by the copyright holders of that material) supplement the terms of this License with terms:

* a) Disclaiming warranty or limiting liability differently from the terms of sections 15 and 16 of this License; or * b) Requiring preservation of specified reasonable legal notices or author attributions in that material or in the Appropriate Legal Notices displayed by works containing it; or * c) Prohibiting misrepresentation of the origin of that material, or requiring that modified versions of such material be marked in reasonable ways as different from the original version; or * d) Limiting the use for publicity purposes of names of licensors or authors of the material; or * e) Declining to grant rights under trademark law for use of some trade names, trademarks, or service marks; or * f) Requiring indemnification of licensors and authors of that material by anyone who conveys the material (or modified versions of it) with contractual assumptions of liability to the recipient, for any liability that these contractual assumptions directly impose on those licensors and authors.

All other non-permissive additional terms are considered "further restrictions" within the meaning of section 10. If the Program as you received it, or any part of it, contains a notice stating that it is governed by this License along with a term that is a further restriction, you may remove that term. If a license document contains a further restriction but permits relicensing or conveying under this License, you may add to a covered work material governed by the terms of that license document, provided that the further restriction does not survive such relicensing or conveying.

If you add terms to a covered work in accord with this section, you must place, in the relevant source files, a statement of the additional terms that apply to those files, or a notice indicating where to find the applicable terms.

Additional terms, permissive or non-permissive, may be stated in the form of a separately written license, or stated as exceptions; the above requirements apply either way. 8. Termination.

You may not propagate or modify a covered work except as expressly provided under this License. Any attempt otherwise to propagate or modify it is void, and will automatically terminate your rights under this License (including any patent licenses granted under the third paragraph of section 11).

However, if you cease all violation of this License, then your license from a particular copyright holder is reinstated (a) provisionally, unless and until the copyright holder explicitly and finally terminates

your license, and (b) permanently, if the copyright holder fails to notify you of the violation by some reasonable means prior to 60 days after the cessation.

Moreover, your license from a particular copyright holder is reinstated permanently if the copyright holder notifies you of the violation by some reasonable means, this is the first time you have received notice of violation of this License for any work) from that copyright holder, and you cure the violation prior to 30 days after your receipt of the notice.

Termination of your rights under this section does not terminate the licenses of parties who have received copies or rights from you under this License. If your rights have been terminated and not permanently reinstated, you do not qualify to receive new licenses for the same material under section 10. 9. Acceptance Not Required for Having Copies.

You are not required to accept this License in order to receive or run a copy of the Program. Ancillary propagation of a covered work occurring solely as a consequence of using peer-to-peer transmission to receive a copy likewise does not require acceptance. However, nothing other than this License grants you permission to propagate or modify any covered work. These actions infringe copyright if you do not accept this License. Therefore, by modifying or propagating a covered work, you indicate your acceptance of this License to do so. 10. Automatic Licensing of Downstream Recipients.

Each time you convey a covered work, the recipient automatically receives a license from the original licensors, to run, modify and propagate that work, subject to this License. You are not responsible for enforcing compliance by third parties with this License.

An "entity transaction" is a transaction transferring control of an organization, or substantially all assets of one, or subdividing an organization, or merging organizations. If propagation of a covered work results from an entity transaction, each party to that transaction who receives a copy of the work also receives whatever licenses to the work the party's predecessor in interest had or could give under the previous paragraph, plus a right to possession of the Corresponding Source of the work from the predecessor in interest, if the predecessor has it or can get it with reasonable efforts.

You may not impose any further restrictions on the exercise of the rights granted or affirmed under this License. For example, you may not impose a license fee, royalty, or other charge for exercise of rights granted under this License, and you may not initiate litigation (including a cross-claim or counterclaim in a lawsuit) alleging that any patent claim is infringed by making, using, selling, offering for sale, or importing the Program or any portion of it. 11. Patents.

A "contributor" is a copyright holder who authorizes use under this License of the Program or a work on which the Program is based. The work thus licensed is called the contributor's "contributor version".

A contributor's "essential patent claims" are all patent claims owned or controlled by the contributor, whether already acquired or hereafter acquired, that would be infringed by some manner, permitted by this License, of making, using, or selling its contributor version, but do not include claims that would be infringed only as a consequence of further modification of the contributor version. For purposes of this definition, "control" includes the right to grant patent sublicenses in a manner consistent with the requirements of this License.

Each contributor grants you a non-exclusive, worldwide, royalty-free patent license under the contributor's essential patent claims, to make, use, sell, offer for sale, import and otherwise run, modify and propagate the contents of its contributor version.

In the following three paragraphs, a "patent license" is any express agreement or commitment, however denominated, not to enforce a patent (such as an express promise to practice a patent or covenant not to sue for patent infringement). To "grant" such a patent license to a party means to make such an agreement or commitment not to enforce a patent against the party.

If you convey a covered work, knowingly relying on a patent license, and the Corresponding Source of the work is not available for anyone to copy, free of charge and under the terms of this License, through a publicly available network server or other readily accessible means, then you must either (1) cause the Corresponding Source to be so available, or (2) arrange to deprive yourself of the benefit of the patent license for this particular work, or (3) arrange, in a manner consistent with the requirements of this License, to extend the patent license to downstream recipients. "Knowingly relying" means you have actual knowledge that, but for the patent license, your conveying the covered work in a country, or your recipient's use of the covered work in a country, would infringe one or more identifiable patents in that country that you have reason to believe are valid.

If, pursuant to or in connection with a single transaction or arrangement, you convey, or propagate by procuring conveyance of, a covered work, and grant a patent license to some of the parties receiving the covered work authorizing them to use, propagate, modify or convey a specific copy of the covered work, then the patent license you grant is automatically extended to all recipients of the covered work and works based on it.

A patent license is "discriminatory" if it does not include within the scope of its coverage, prohibits the exercise of, or is conditioned on the non-exercise of one or more of the rights that are specifically granted under this License. You may not convey a covered work if you are a party to an arrangement with a third party that is in the business of distributing software, under which you make payment to the third party based on the extent of your activity of conveying the work, and under which the third party grants, to any of the parties who would receive the covered work from you, a discriminatory patent license (a) in connection with copies of the covered work conveyed by you (or copies made from those copies), or (b) primarily for and in connection with specific products or compilations that contain the covered work, unless you entered into that arrangement, or that patent license was granted, prior to 28 March 2007.

Nothing in this License shall be construed as excluding or limiting any implied license or other defenses to infringement that may otherwise be available to you under applicable patent law. 12. No Surrender of Others' Freedom.

If conditions are imposed on you (whether by court order, agreement or otherwise) that contradict the conditions of this License, they do not excuse you from the conditions of this License. If you cannot convey a covered work so as to satisfy simultaneously your obligations under this License and any other pertinent obligations, then as a consequence you may not convey it at all. For example, if you agree to terms that obligate you to collect a royalty for further conveying from those to whom you convey the Program, the only way you could satisfy

both those terms and this License would be to refrain entirely from conveying the Program. 13. Use with the GNU Affero General Public License.

Notwithstanding any other provision of this License, you have permission to link or combine any covered work with a work licensed under version 3 of the GNU Affero General Public License into a single combined work, and to convey the resulting work. The terms of this License will continue to apply to the part which is the covered work, but the special requirements of the GNU Affero General Public License, section 13, concerning interaction through a network will apply to the combination as such. 14. Revised Versions of this License.

The Free Software Foundation may publish revised and/or new versions of the GNU General Public License from time to time. Such new versions will be similar in spirit to the present version, but may differ in detail to address new problems or concerns.

Each version is given a distinguishing version number. If the Program specifies that a certain numbered version of the GNU General Public License "or any later version" applies to it, you have the option of following the terms and conditions either of that numbered version or of any later version published by the Free Software Foundation. If the Program does not specify a version number of the GNU General Public License, you may choose any version ever published by the Free Software Foundation.

If the Program specifies that a proxy can decide which future versions of the GNU General Public License can be used, that proxy's public statement of acceptance of a version permanently authorizes you to choose that version for the Program.

92.2 GNU Free Documentation License

Version 1.3, 3 November 2008

Copyright (c) 2000, 2001, 2002, 2007, 2008 Free Software Foundation, Inc. <<http://fsf.org/>>

Everyone is permitted to copy and distribute verbatim copies of this license document, but changing it is not allowed. 0. PREAMBLE

The purpose of this License is to make a manual, textbook, or other functional and useful document "free" in the sense of freedom: to assure everyone the effective freedom to copy and redistribute it, with or without modifying it, either commercially or noncommercially. Secondly, this License preserves for the author and publisher a way to get credit for their work, while not being considered responsible for modifications made by others.

This License is a kind of "copyleft", which means that derivative works of the document must themselves be free in the same sense. It complements the GNU General Public License, which is a copyleft license designed for free software.

We have designed this License in order to use it for manuals for free software, because free software needs free documentation: a free program should come with manuals providing the same freedoms that the software does. But this License is not limited to software manuals; it can be used for any textual work, regardless of subject matter or whether it is published as a printed book. We recommend this License principally for works whose purpose is instruction or reference. 1. APPLICABILITY AND DEFINITIONS

This License applies to any manual or other work, in any medium, that contains a notice placed by the copyright holder saying it can be distributed under the terms of this License. Such a notice grants a world-wide, royalty-free license, unlimited in duration, to use that work under the conditions stated herein. The "Document", below, refers to any such manual or work. Any member of the public is a licensee, and is addressed as "you". You accept the license if you copy, modify or distribute the work in a way requiring permission under copyright law.

A "Modified Version" of the Document means any work containing the Document or a portion of it, either copied verbatim, or with modifications and/or translated into another language.

A "Secondary Section" is a named appendix or a front-matter section of the Document that deals exclusively with the relationship of the publishers or authors of the Document to the Document's overall subject (or to related matters) and contains nothing that could fall directly within that overall subject. (Thus, if the Document is in part a textbook of mathematics, a Secondary Section may not explain any mathematics.) The relationship could be a matter of historical connection with the subject or with related matters, or of legal, commercial, philosophical, ethical or political position regarding them.

The "Invariant Sections" are certain Secondary Sections whose titles are designated, as being those of Invariant Sections, in the notice that says that the Document is released under this License. If a section does not fit the above definition of Secondary then it is not allowed to be designated as Invariant. The Document may contain zero Invariant Sections. If the Document does not identify any Invariant Sections then there are none.

The "Cover Texts" are certain short passages of text that are listed, as Front-Cover Texts or Back-Cover Texts, in the notice that says that the Document is released under this License. A Front-Cover Text may be at most 5 words, and a Back-Cover Text may be at most 25 words.

A "Transparent" copy of the Document means a machine-readable copy, represented in a format whose specification is available to the general public, that is suitable for revising the document straightforwardly with generic text editors or (for images composed of pixels) generic paint programs or (for drawings) some widely available drawing editor, and that is suitable for input to text formatters or for automatic translation to a variety of formats suitable for input to text formatters. A copy made in an otherwise Transparent file format whose markup, or absence of markup, has been arranged to thwart or discourage subsequent modification by readers is not Transparent. An image format is not Transparent if used for any substantial amount of text. A copy that is not "Transparent" is called "Opaque".

Examples of suitable formats for Transparent copies include plain ASCII without markup, Texinfo input format, LaTeX input format, SGML or XML using a publicly available DTD, and standard-conforming simple HTML, PostScript or PDF designed for human modification. Examples of transparent image formats include PNG, XCF and JPG. Opaque formats include proprietary formats that can be read and edited only by proprietary word processors, SGML or XML for which the DTD and/or processing tools are not generally available, and the machine-generated HTML, PostScript or PDF produced by some word processors for output purposes only.

The "Title Page" means, for a printed book, the title page itself, plus such following pages as are needed to hold, legibly, the material this License requires to appear in the title page. For works in formats which do not have any title page as such, "Title Page" means the text near the most prominent appearance of the work's title, preceding the beginning of the body of the text.

The "publisher" means any person or entity that distributes copies of the Document to the public.

A section "Entitled XYZ" means a named subunit of the Document whose title either is precisely XYZ or contains XYZ in parentheses

Later license versions may give you additional or different permissions. However, no additional obligations are imposed on any author or copyright holder as a result of your choosing to follow a later version. 15. Disclaimer of Warranty.

THESE ARE NO WARRANTIES FOR THE PROGRAM, TO THE EXTENT PERMITTED BY APPLICABLE LAW. EXCEPT WHEN OTHERWISE STATED IN WRITING THE COPYRIGHT HOLDERS AND/OR OTHER PARTIES PROVIDE THE PROGRAM "AS IS" WITHOUT WARRANTY OF ANY KIND, EITHER EXPRESSED OR IMPLIED, INCLUDING, BUT NOT LIMITED TO, THE IMPLIED WARRANTIES OF MERCHANTABILITY AND FITNESS FOR A PARTICULAR PURPOSE. THE ENTIRE RISK AS TO THE QUALITY AND PERFORMANCE OF THE PROGRAM IS WITH YOU. SHOULD THE PROGRAM PROVE DEFECTIVE, YOU ASSUME THE COST OF ALL NECESSARY SERVICING, REPAIR OR CORRECTION. 16. Limitation of Liability.

IN NO EVENT UNLESS REQUIRED BY APPLICABLE LAW OR AGREED TO IN WRITING WILL ANY COPYRIGHT HOLDER, OR ANY OTHER PARTY WHO MODIFIES AND/OR CONVEYS THE PROGRAM AS PERMITTED ABOVE, BE LIABLE TO YOU FOR DAMAGES, INCLUDING ANY GENERAL, SPECIAL, INCIDENTAL OR CONSEQUENTIAL DAMAGES ARISING OUT OF THE USE OR INABILITY TO USE THE PROGRAM (INCLUDING BUT NOT LIMITED TO LOSS OF DATA OR DATA BEING RENDERED INACCURATE OR LOSSES SUSTAINED BY YOU OR THIRD PARTIES OR A FAILURE OF THE PROGRAM TO OPERATE WITH ANY OTHER PROGRAMS), EVEN IF SUCH HOLDER OR OTHER PARTY HAS BEEN ADVISED OF THE POSSIBILITY OF SUCH DAMAGES. 17. Interpretation of Sections 15 and 16.

following text that translates XYZ in another language. (Here XYZ stands for a specific section name mentioned below, such as "Acknowledgements", "Dedications", "Endorsements", or "History"). To "Preserve the Title" of such a section when you modify the Document means that it remains a section "Entitled XYZ" according to this definition.

The Document may include Warranty Disclaimers next to the notice which states that this License applies to the Document. These Warranty Disclaimers are considered to be included by reference in this License, but only as regards disclaiming warranties; any other implication that these Warranty Disclaimers may have is void and has no effect on the meaning of this License. 2. VERBATIM COPYING

You may copy and distribute the Document in any medium, either commercially or noncommercially, provided that this License, the copyright notices, and the license notice saying this License applies to the Document are reproduced in all copies, and that you add no other conditions whatsoever to those of this License. You may not use technical measures to obstruct or control the reading or further copying of the copies you make or distribute. However, you may accept compensation in exchange for copies. If you distribute a large enough number of copies you must also follow the conditions in section 3.

You may also lend copies, under the same conditions stated above, and you may publicly display copies. 3. COPYING IN QUANTITY

If you publish printed copies (or copies in media that commonly have printed covers) of the Document, numbering more than 100, and the Document's license notice requires Cover Texts, you must enclose the copies in covers that carry, clearly and legibly, all these Cover Texts: Front-Cover Texts on the front cover, and Back-Cover Texts on the back cover. Both covers must also clearly and legibly identify you as the publisher of these copies. The front cover must present the full title with all words of the title equally prominent and visible. You may add other material on the covers in addition. Copying with changes limited to the covers, as long as they preserve the title of the Document and satisfy these conditions, can be treated as verbatim copying in other respects.

If the required texts for either cover are too voluminous to fit legibly, you should put the first one listed (as many as fit reasonably) on the actual cover, and continue the rest onto adjacent pages.

If you publish or distribute Opaque copies of the Document numbering more than 100, you must either include a machine-readable Transparent copy along with each Opaque copy, or state in or with each Opaque copy a computer-network location from which the general networking-using public has access to download using public-standard network protocols a complete Transparent copy of the Document, free of additional material. If you use the latter option, you must take reasonably prudent steps, when you begin distribution of Opaque copies in quantity, to ensure that this Transparent copy will remain thus accessible at the stated location until at least one year after the last time you distribute an Opaque copy (directly or through your agents or retailers) of that edition to the public.

It is requested, but not required, that you contact the authors of the Document well before redistributing any large number of copies, to give them a chance to provide you with an updated version of the Document. 4. MODIFICATIONS

You may copy and distribute a Modified Version of the Document under the conditions of sections 2 and 3 above, provided that you release the Modified Version precisely as the full text of Invariant Sections and required Cover Texts given in the Document's license notice. In addition, you must do these things in the Modified Version:

- A. Use in the Title Page (and on the covers, if any) a title distinct from that of the Document, and from those of previous versions (which should, if there were any, be listed in the History section of the Document). You may use the same title as a previous version if the original publisher of that version gives permission.
- B. List on the Title Page, as authors, one or more persons or entities responsible for authorship of the modifications in the Modified Version, together with at least five of the principal authors of the Document (all of its principal authors, if it has fewer than five), unless they release you from this requirement.
- C. State on the Title page the name of the publisher of the Modified Version, as the publisher.
- D. Preserve all the copyright notices of the Document.
- E. Add an appropriate copyright notice for your modifications adjacent to the other copyright notices.
- F. Include, immediately after the copyright notices, a license notice giving the public permission to use the Modified Version under the terms of this License, in the form shown in the Appendix below.
- G. Preserve the network location, if any, given in the Document for public access to a Transparent copy of the Document, and likewise the network locations given in the Document for previous versions if they were based on. These may be placed in the "History" section. You may omit a network location for a work that was published at least four years before the Document itself, or if the original publisher of the version it refers to gives permission.
- K. For its original publisher "Acknowledgements" or "Dedications", Preserve the Title of the section, and preserve in the section all the substance and tone of each of the contributor acknowledgements and/or dedications given therein.
- L. Preserve all the Invariant Sections of the Document, unaltered in their text and

if the disclaimer of warranty and limitation of liability provided above cannot be given local legal effect according to their terms, reviewing courts shall apply local law that most closely approximates an absolute waiver of all civil liability in connection with the Program, unless a warranty or assumption of liability accompanies a copy of the Program in return for a fee.

END OF TERMS AND CONDITIONS How to Apply These Terms to Your New Programs

If you develop a new program, and you want it to be of the greatest possible use to the public, the best way to achieve this is to make it free software which everyone can redistribute and change under these terms.

To do so, attach the following notices to the program. It is safest to attach them to the start of each source file to most effectively state the exclusion of warranty; and each file should have at least the "copyright" line and a pointer to where the full notice is found.

```
<one line to give the program's name and a brief idea of what it does.>
Copyright (C) <year> <name of author>
```

This program is free software: you can redistribute it and/or modify it under the terms of the GNU General Public License as published by the Free Software Foundation, either version 3 of the License, or (at your option) any later version.

This program is distributed in the hope that it will be useful, but WITHOUT ANY WARRANTY; without even the implied warranty of MERCHANTABILITY or FITNESS FOR A PARTICULAR PURPOSE. See the GNU General Public License for more details.

in their titles. Section numbers or the equivalent are not considered part of the section titles. * M. Delete any section Entitled "Endorsements". Such a section may not be included in the Modified Version. * N. Do not retitle any existing section to be Entitled "Endorsements" or to conflict in title with any Invariant Section. * O. Preserve any Warranty Disclaimers.

If the Modified Version includes new front-matter sections or appendices that qualify as Secondary Sections and contain no material copied from the Document, you may at your option designate some or all of these sections as invariant. To do this, add their titles to the list of Invariant Sections in the Modified Version's license notice. These titles must be distinct from any other section titles.

You may add a section Entitled "Endorsements", provided it contains nothing but endorsements of your Modified Version by various parties—for example, statements of peer review or of the text has been approved by an organization as the authoritative definition of a standard.

You may add a passage of up to five words as a Front-Cover Text, and a passage of up to 25 words as a Back-Cover Text, to the end of the list of Cover Texts in the Modified Version. Only one passage of Front-Cover Text and one of Back-Cover Text may be added (by or through arrangements made by) any one entity. If the Document already includes a cover text for the same cover, previously added by you or by arrangement made by the same entity you are acting on behalf of, you may not add another; but you may replace the old one, on explicit permission from the previous publisher that added the old one.

The author(s) and publisher(s) of the Document do not by this License give permission to use their names for publicity for or to assert or imply endorsement of any Modified Version. 5. COMBINING DOCUMENTS

You may combine the Document with other documents released under this License, under the terms defined in section 4 above for modified versions, provided that you include in the combination all of the Invariant Sections of all of the original documents, unmodified, and list them all as Invariant Sections of your combined work in its license notice, and that you preserve all their Warranty Disclaimers.

The combined work need only contain one copy of this License, and multiple identical Invariant Sections may be replaced with a single copy. If there are multiple Invariant Sections with the same name but different contents, make the title of each such section unique by adding at the end of it, in parentheses, the name of the original author or publisher of that section if known, or else a unique number. Make the same adjustment to the section titles in the list of Invariant Sections in the license notice of the combined work.

In the combination, you must combine any sections Entitled "History" in the various original documents, forming one section Entitled "History"; likewise combine any sections Entitled "Acknowledgements", and any sections Entitled "Dedications". You must delete all sections Entitled "Endorsements". 6. COLLECTIONS OF DOCUMENTS

You may make a collection consisting of the Document and other documents released under this License, and replace the individual copies of this License in the various documents with a single copy that is included in the collection, provided that you follow the rules of this License for verbatim copying of each of the documents in all other respects.

You may extract a single document from such a collection, and distribute it individually under this License, provided you insert a copy of this License into the extracted document, and follow this License in all other respects regarding verbatim copying of that document. 7. AGGREGATION WITH INDEPENDENT WORKS

A compilation of the Document or its derivatives with other separate and independent documents or works, in or on a volume of a storage or distribution medium, is called an "aggregate" if the copyright resulting from the compilation is not used to limit the legal rights of the compilation's users beyond what the individual works permit. When the Document is included in an aggregate, this License does not apply to the other works in the aggregate which are not themselves derivative works of the Document.

If the Cover Text requirement of section 3 is applicable to these copies of the Document, then if the Document is less than one half of the entire aggregate, the Document's Cover Texts may be placed on covers that bracket the Document within the aggregate, or the electronic equivalent of covers if the Document is in electronic form. Otherwise they must appear on printed covers that bracket the whole aggregate. 8. TRANSLATION

Translation is considered a kind of modification, so you may distribute translations of the Document under the terms of section 4. Replacing Invariant Sections with translations requires special permission from their copyright holders, but you may include translations of some or all Invariant Sections in addition to the original versions of these Invariant Sections. You may include a translation of this License, and all the license notices in the Document, and any Warranty Disclaimers, provided that you also include the original English version of this License and the original versions of those notices and disclaimers. In case of a disagreement between the translation and the original version of this License or a notice or disclaimer, the original version will prevail.

If a section in the Document is Entitled "Acknowledgements", "Dedications", or "History", the requirement (section 4) to Preserve its Title

You should have received a copy of the GNU General Public License along with this program. If not, see <<http://www.gnu.org/licenses/>>.

Also add information on how to contact you by electronic and paper mail.

If the program does terminal interaction, make it output a short notice like this when it starts in an interactive mode:

```
<program> Copyright (C) <year> <name of author> This program
comes with ABSOLUTELY NO WARRANTY; for details type 'show
w'. This is free software, and you are welcome to redistribute it
under certain conditions; type 'show c' for details.
```

The hypothetical commands 'show w' and 'show c' should show the appropriate parts of the General Public License. Of course, your program's commands might be different; for a GUI interface, you would use an "about box".

You should also get your employer (if you work as a programmer) or school, if any, to sign a "copyright disclaimer" for the program, if necessary. For more information on this, and how to apply and follow the GNU GPL, see <<http://www.gnu.org/licenses/>>.

The GNU General Public License does not permit incorporating your program into proprietary programs. If you link your program to a subroutine library, you may consider it more useful to permit linking proprietary applications with the library. If this is what you want to do, use the GNU Lesser General Public License instead of this License. But first, please read <<http://www.gnu.org/philosophy/why-not-lgpl.html>>.

(section 1) will typically require changing the actual title. 9. TERMINATION

You may not copy, modify, sublicense, or distribute the Document except as expressly provided under this License. Any attempt otherwise to copy, modify, sublicense, or distribute it is void, and will automatically terminate your rights under this License.

However, if you cease all violation of this License, then your license from a particular copyright holder is reinstated (a) provisionally, unless and until the copyright holder explicitly and finally terminates your license, and (b) permanently, if the copyright holder fails to notify you of the violation by some reasonable means prior to 60 days after the cessation.

Moreover, your license from a particular copyright holder is reinstated permanently if the copyright holder notifies you of the violation by some reasonable means, this is the first time you have received notice of violation of this License (or any time) from that copyright holder, and you cure the violation prior to 30 days after your receipt of the notice.

Termination of your rights under this section does not terminate the licenses of parties who have received copies or rights from you under this License. If your rights have been terminated and not permanently reinstated, receipt of a copy of some or all of the same material does not give you any rights to use it. 10. FUTURE REVISIONS OF THIS LICENSE

The Free Software Foundation may publish new, revised versions of the GNU Free Documentation License from time to time. Such new versions will be similar in spirit to the present version, but may differ in detail to address new problems or concerns. See <<http://www.gnu.org/copyleft/>>.

Each version of the License is given a distinguishing version number. If the Document specifies that a particular numbered version of this License "or any later version" applies to it, you have the option of following the terms and conditions either of that specified version or of any later version that has been published (not as a draft) by the Free Software Foundation. If the Document does not specify a version number of this License, you may choose any version ever published (not as a draft) by the Free Software Foundation. If the Document specifies that a proxy can decide which future versions of this License can be used, that proxy's public statement of acceptance of a version permanently authorizes you to choose that version for the Document. 11. RELICENSING

"Massive Multiauthor Collaboration Site" (or "MMC Site") means any World Wide Web server that publishes copyrightable works and also provides prominent facilities for anybody to edit those works. A public wiki that anybody can edit is an example of such a server. A "Massive Multiauthor Collaboration" (or "MMC") contained in the site means any set of copyrightable works thus published on the MMC site.

"CC-BY-SA" means the Creative Commons Attribution-Share Alike 3.0 license published by Creative Commons Corporation, a not-for-profit corporation with a principal place of business in San Francisco, California, as well as future copyleft versions of that license published by that same organization.

"Incorporate" means to publish or republish a Document, in whole or in part, as part of another Document.

An MMC is "eligible for relicensing" if it is licensed under this License, and if all works that were first published under this License somewhere other than this MMC, and subsequently incorporated in whole or in part into the MMC, (1) had no cover texts or invariant sections, and (2) were thus incorporated prior to November 1, 2008.

The operator of an MMC Site may republish an MMC contained in the site under CC-BY-SA on the same site at any time before August 1, 2009, provided the MMC is eligible for relicensing. ADDENDUM: How to use this License for your documents

To use this License in a document you have written, include a copy of the License in the document and put the following copyright and license notices just after the title page:

```
Copyright (C) YEAR YOUR NAME. Permission is granted to copy,
distribute and/or modify this document under the terms of the GNU
Free Documentation License, Version 1.3 or any later version
published by the Free Software Foundation; with no Invariant
Sections, no Front-Cover Texts, and no Back-Cover Texts. A copy of the
License is included in the section entitled "GNU Free Documentation
License".
```

If you have Invariant Sections, Front-Cover Texts and Back-Cover Texts, replace the "with ... Texts." line with this:

```
with the Invariant Sections being LIST THEIR TITLES, with the
Front-Cover Texts being LIST, and with the Back-Cover Texts being
LIST.
```

If you have Invariant Sections without Cover Texts, or some other combination of the three, merge those two alternatives to suit the situation.

If your document contains nontrivial examples of program code, you recommend releasing these examples in parallel under your choice of free software license, such as the GNU General Public License, to permit their use in free software.

92.3 GNU Lesser General Public License

GNU LESSER GENERAL PUBLIC LICENSE

Version 3, 29 June 2007

Copyright © 2007 Free Software Foundation, Inc. <<http://fsf.org/>>

Everyone is permitted to copy and distribute verbatim copies of this license document, but changing it is not allowed.

This version of the GNU Lesser General Public License incorporates the terms and conditions of version 3 of the GNU General Public License, supplemented by the additional permissions listed below.

0. Additional Definitions.

As used herein, “this License” refers to version 3 of the GNU Lesser General Public License, and the “GNU GPL” refers to version 3 of the GNU General Public License.

“The Library” refers to a covered work governed by this License, other than an Application or a Combined Work as defined below.

An “Application” is any work that makes use of an interface provided by the Library, but which is not otherwise based on the Library. Defining a subclass of a class defined by the Library is deemed a mode of using an interface provided by the Library.

A “Combined Work” is a work produced by combining or linking an Application with the Library. The particular version of the Library with which the Combined Work was made is also called the “Linked Version”.

The “Minimal Corresponding Source” for a Combined Work means the Corresponding Source for the Combined Work, excluding any source code for portions of the Combined Work that, considered in isolation, are based on the Application, and not on the Linked Version.

The “Corresponding Application Code” for a Combined Work means the object code and/or source code for the Application, including any data and utility programs needed for reproducing the Combined Work from the Application, but excluding the System Libraries of the Combined Work.

1. Exception to Section 3 of the GNU GPL.

You may convey a covered work under sections 3 and 4 of this License without being bound by section 3 of the GNU GPL.

2. Conveying Modified Versions.

If you modify a copy of the Library, and, in your modifications, a facility refers to a function or data to be supplied by an Application that uses the facility (other than as an argument passed when the facility is invoked), then you may convey a copy of the modified version:

* a) under this License, provided that you make a good faith effort to ensure that, in the event an Application does not supply the function or data, the facility still operates, and performs whatever part of its purpose remains meaningful, or

* b) under the GNU GPL, with none of the additional permissions of this License applicable to that copy.

3. Object Code Incorporating Material from Library Header Files.

The object code form of an Application may incorporate material from a header file that is part of the Library. You may convey such object code under terms of your choice, provided that, if the incorporated material is not limited to numerical parameters, data structure layouts and accessors, or small macros, inline functions and templates (ten or fewer lines in length), you do both of the following:

* a) Give prominent notice with each copy of the object code that the Library is used in it and that the Library and its use are covered by this License.

* b) Accompany the object code with a copy of the GNU GPL and this license document.

4. Combined Works.

You may convey a Combined Work under terms of your choice that, taken together, effectively do not restrict modification of the portions of the Library contained in the Combined Work and reverse engineering for debugging such modifications, if you also do each of the following:

* a) Give prominent notice with each copy of the Combined Work that the Library is used in it and that the Library and its use are covered by this License.

* b) Accompany the Combined Work with a copy of the GNU GPL and this license document.

* c) For a Combined Work that displays copyright notices during execution, include the copyright notice for the Library among these notices, as well as a reference directing the user to the copies of the GNU GPL and this license document.

* d) Do one of the following:

- o 0) Convey the Minimal Corresponding Source under the terms of this License, and the Corresponding Application Code in a form suitable for, and under terms that permit, the user to recombine or relink the Application with a modified version of the Linked Version to produce a modified Combined Work, in the manner specified by section 6 of the GNU GPL for conveying Corresponding Source.
- o 1) Use a suitable shared library mechanism for linking with the Library. A suitable mechanism is one that (a) uses at run time a copy of the Library already present on the user's computer system, and (b) will operate properly with a modified version of the Library that is interface-compatible with the Linked Version.
- * e) Provide Installation Information, but only if you would otherwise be required to provide such information under section 6 of the GNU GPL, and only to the extent that such information is necessary to install and execute a modified version of the Combined Work produced by recombining or relinking the Application with a modified version of the Linked Version. (If you use option 4d0, the Installation Information must accompany the Minimal Corresponding Source and Corresponding Application Code. If you use option 4d1, you must provide the Installation Information in the manner specified by section 6 of the GNU GPL for conveying Corresponding Source.)

5. Combined Libraries.

You may place library facilities that are a work based on the Library side by side in a single library together with other library facilities that are not Applications and are not covered by this License, and convey such a combined library under terms of your choice, if you do both of the following:

* a) Accompany the combined library with a copy of the same work based on the Library, uncombined with any other library facilities, conveyed under the terms of this License.

* b) Give prominent notice with the combined library that part of it is a work based on the Library, and explaining where to find the accompanying uncombined form of the same work.

6. Revised Versions of the GNU Lesser General Public License.

The Free Software Foundation may publish revised and/or new versions of the GNU Lesser General Public License from time to time. Such new versions will be similar in spirit to the present version, but may differ in detail to address new problems or concerns.

Each version is given a distinguishing version number. If the Library as you received it specifies that a certain numbered version of the GNU Lesser General Public License “or any later version” applies to it, you have the option of following the terms and conditions either of that published version or of any later version published by the Free Software Foundation. If the Library as you received it does not specify a version number of the GNU Lesser General Public License, you may choose any version of the GNU Lesser General Public License ever published by the Free Software Foundation.

If the Library as you received it specifies that a proxy can decide whether future versions of the GNU Lesser General Public License shall apply, that proxy's public statement of acceptance of any version is permanent authorization for you to choose that version for the Library.